



Booklet available in English on
Heft in deutscher Sprache erhältlich auf
Livret disponible en français sur
Libretto disponibile in Italiano su
Folleto disponible en español en
如需中文版手册, 请访问

LEGO.com/service/buildinginstructions



WELCOME

We are delighted to introduce you to our latest Modular Building set, the 16th building in this popular series. Whether you are building one for the first time or adding to your collection, we hope it gives you hours of LEGO® building fun.



Chris McVeigh, LEGO® Designer



BUILD A STORY

LEGO® Designer Chris McVeigh, and the rest of the LEGO design team, wanted to ensure you could build a story as well as a model with this Police Station set, that's why it's packed with intricate details and hidden features that fuel the imagination. In Chris's narrative, the local newsstand operator has fallen on hard times, but he's dreamt up a sweet scheme to generate headlines and sell papers. Feel free to build further on this or start a completely different story of your own.





LEGO.com/brickseparator

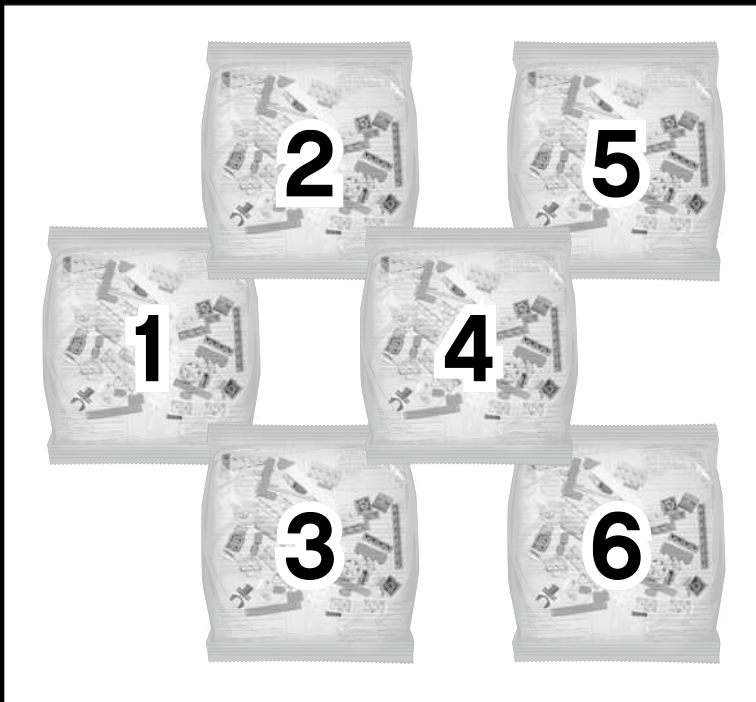



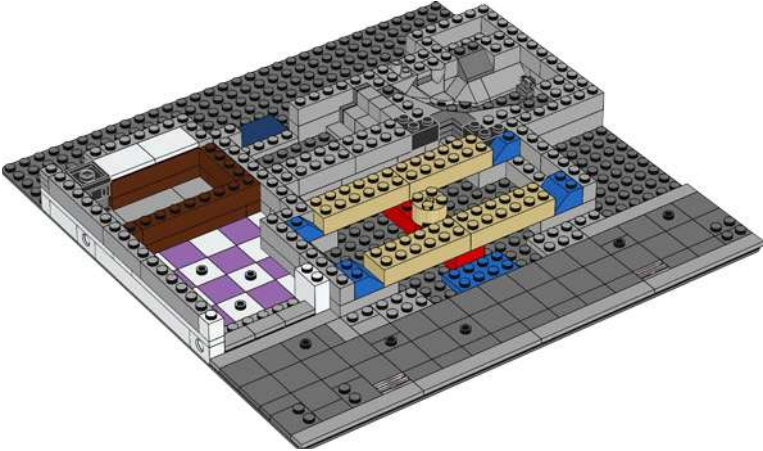
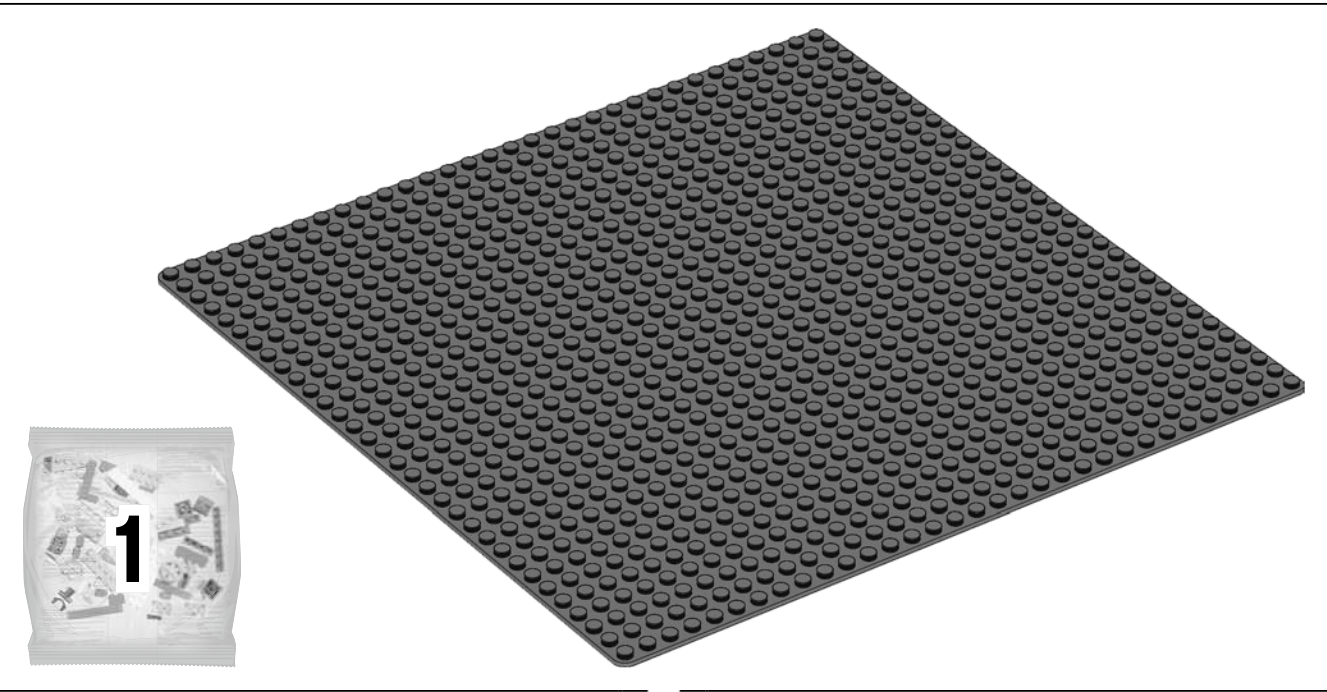

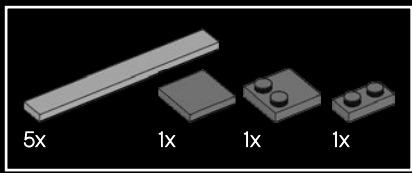

1

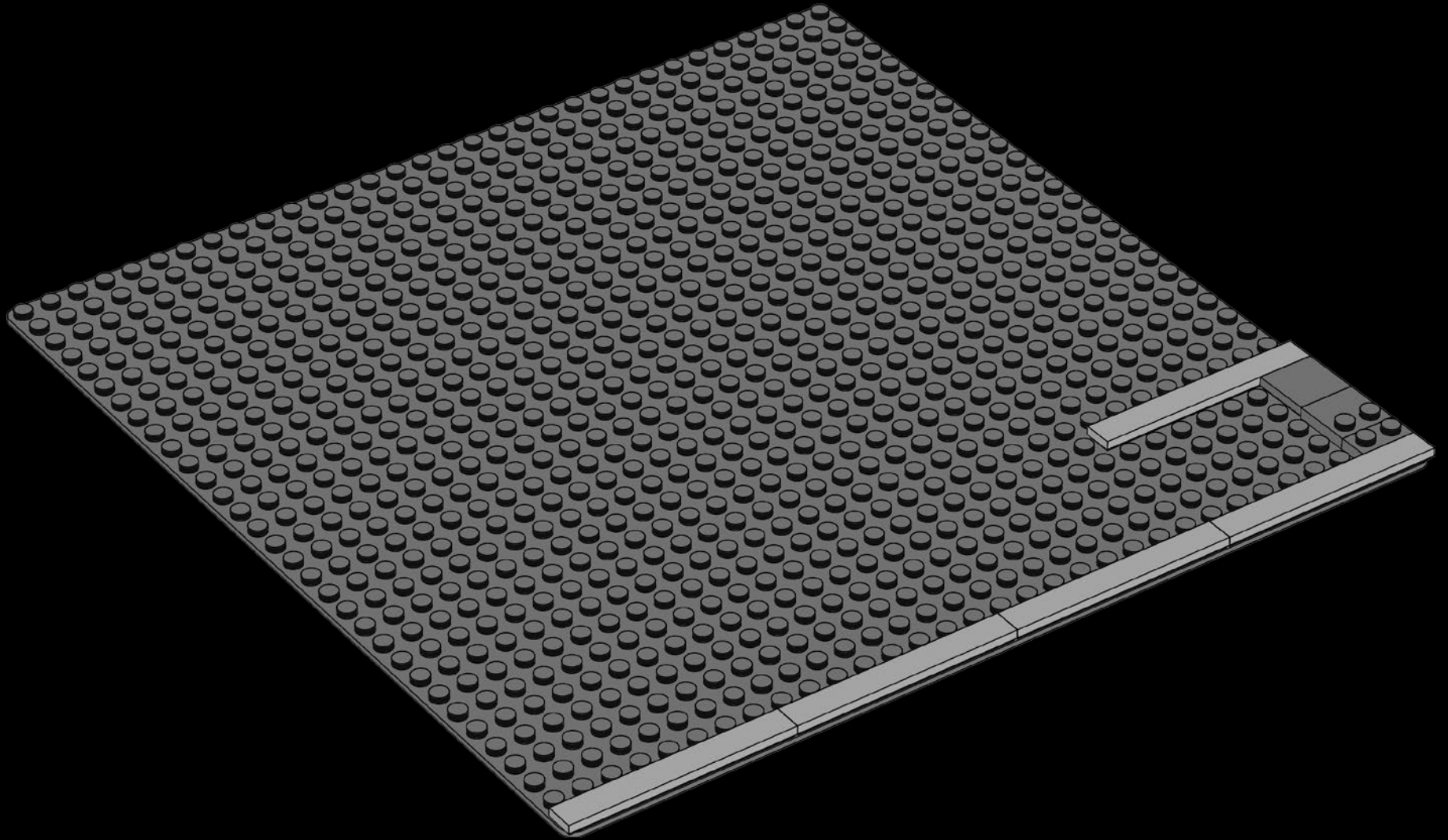

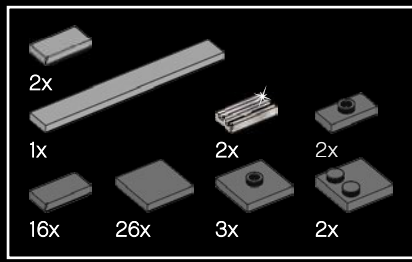

2

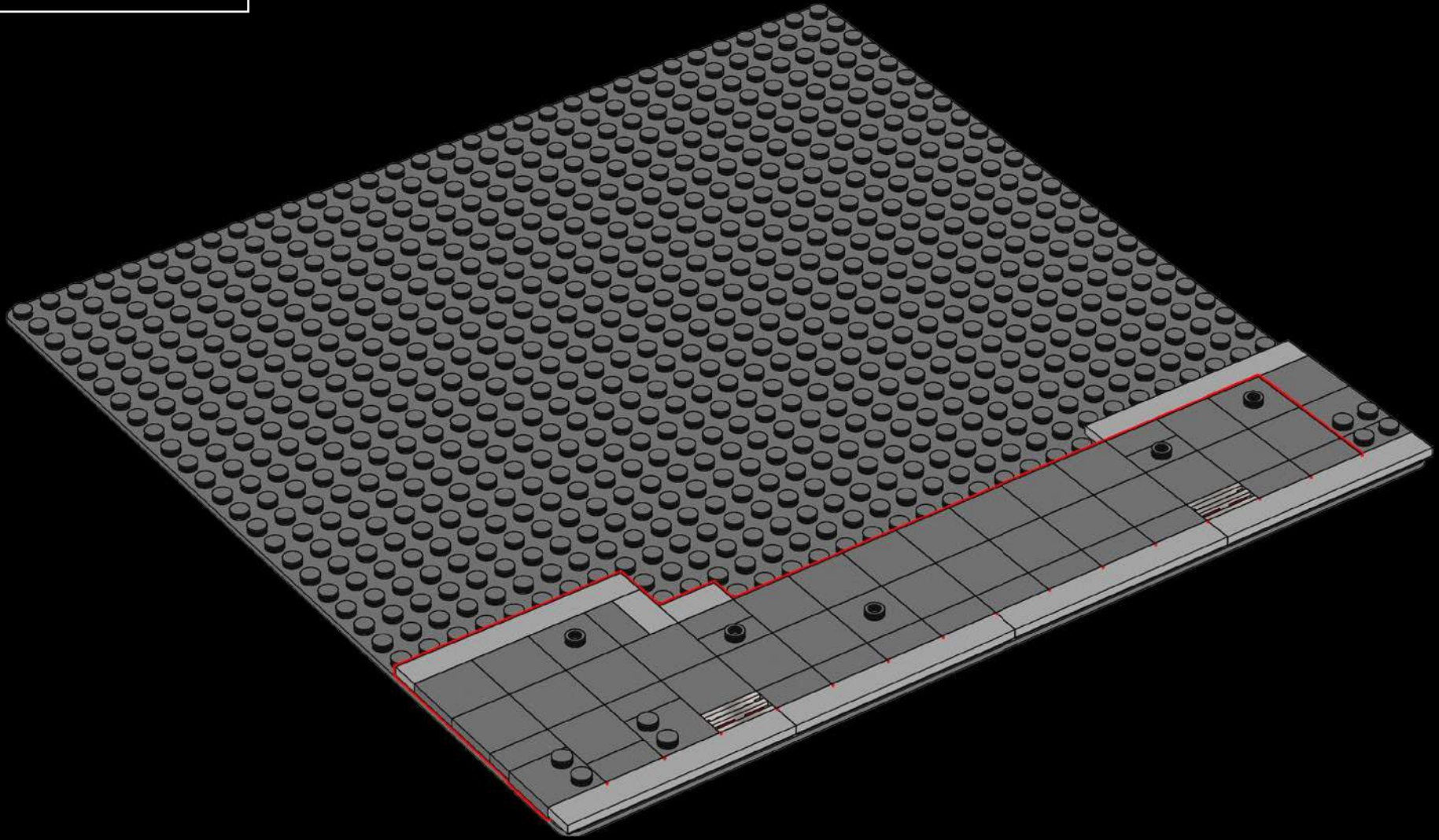

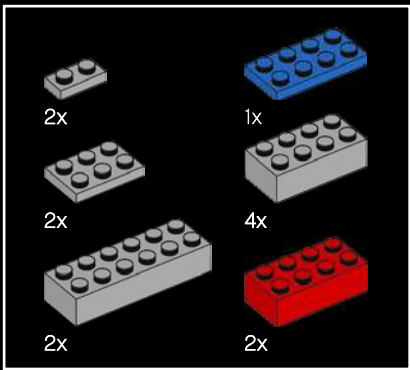

3

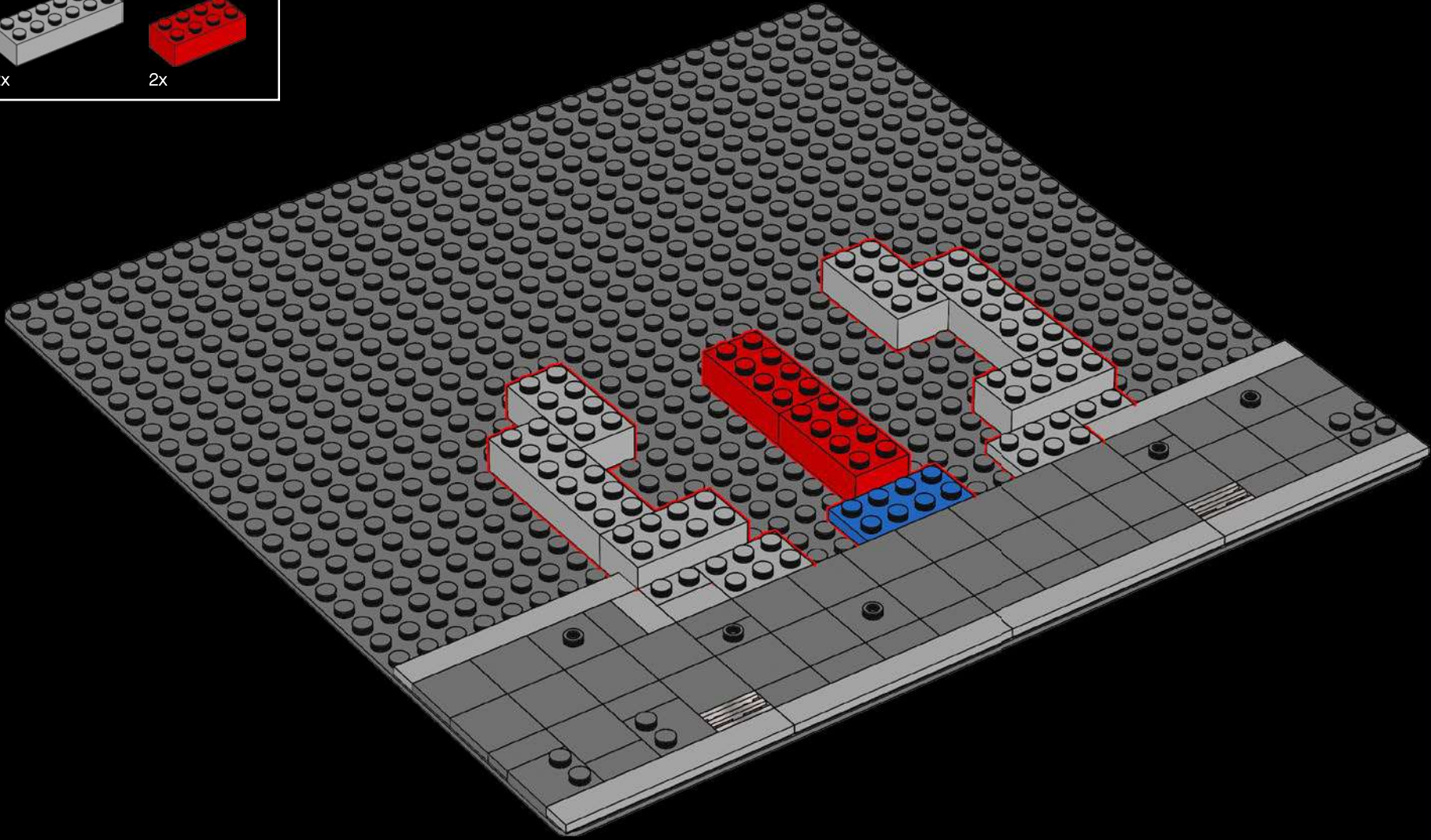

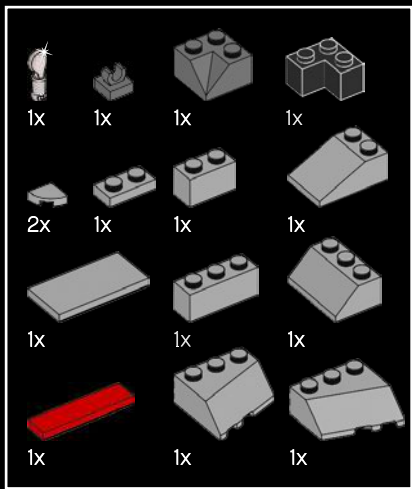

5

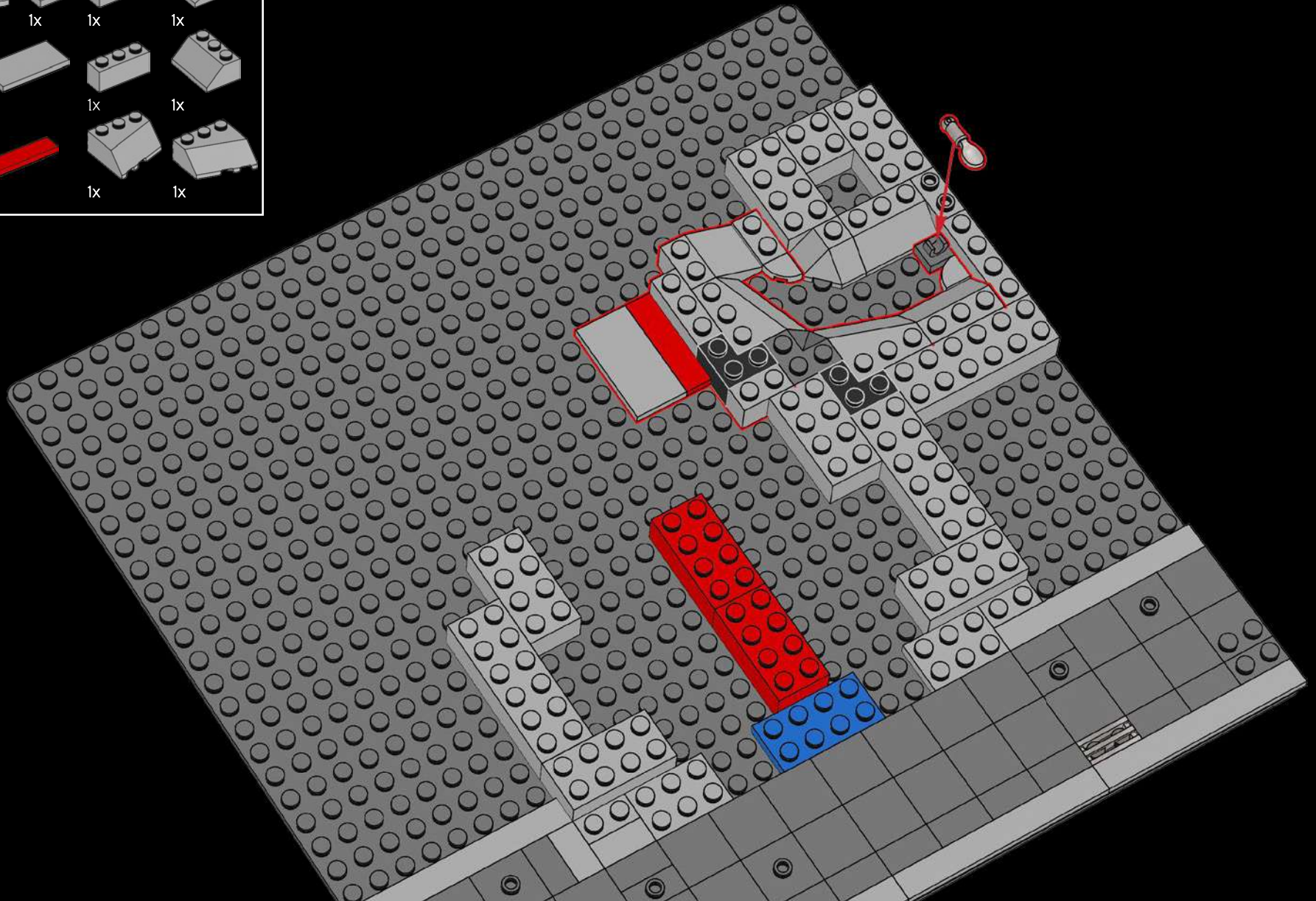

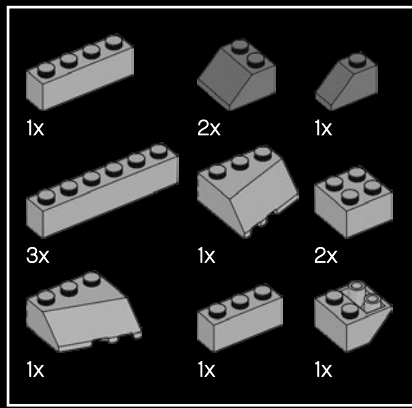

6

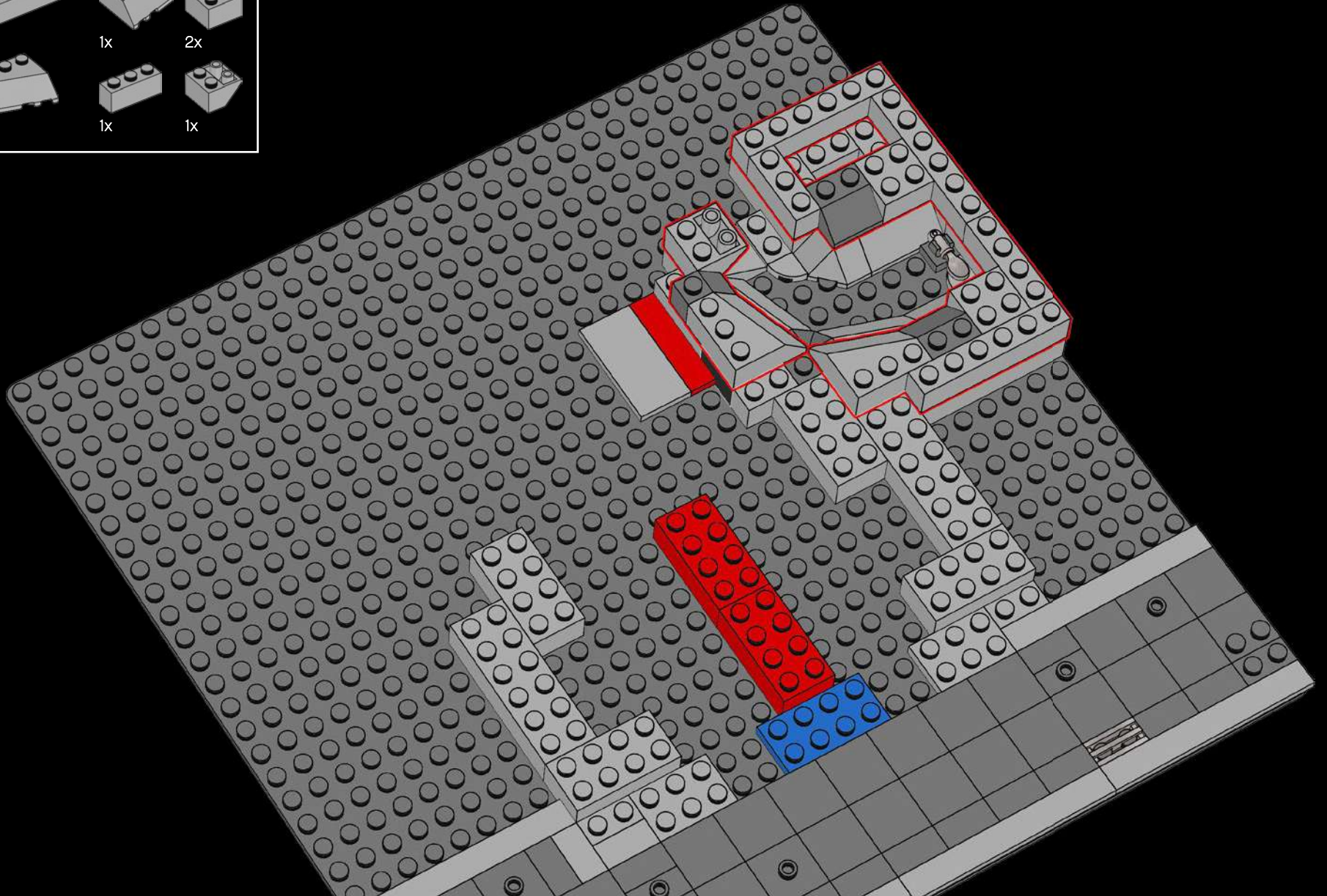

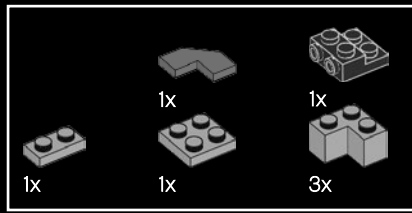

8

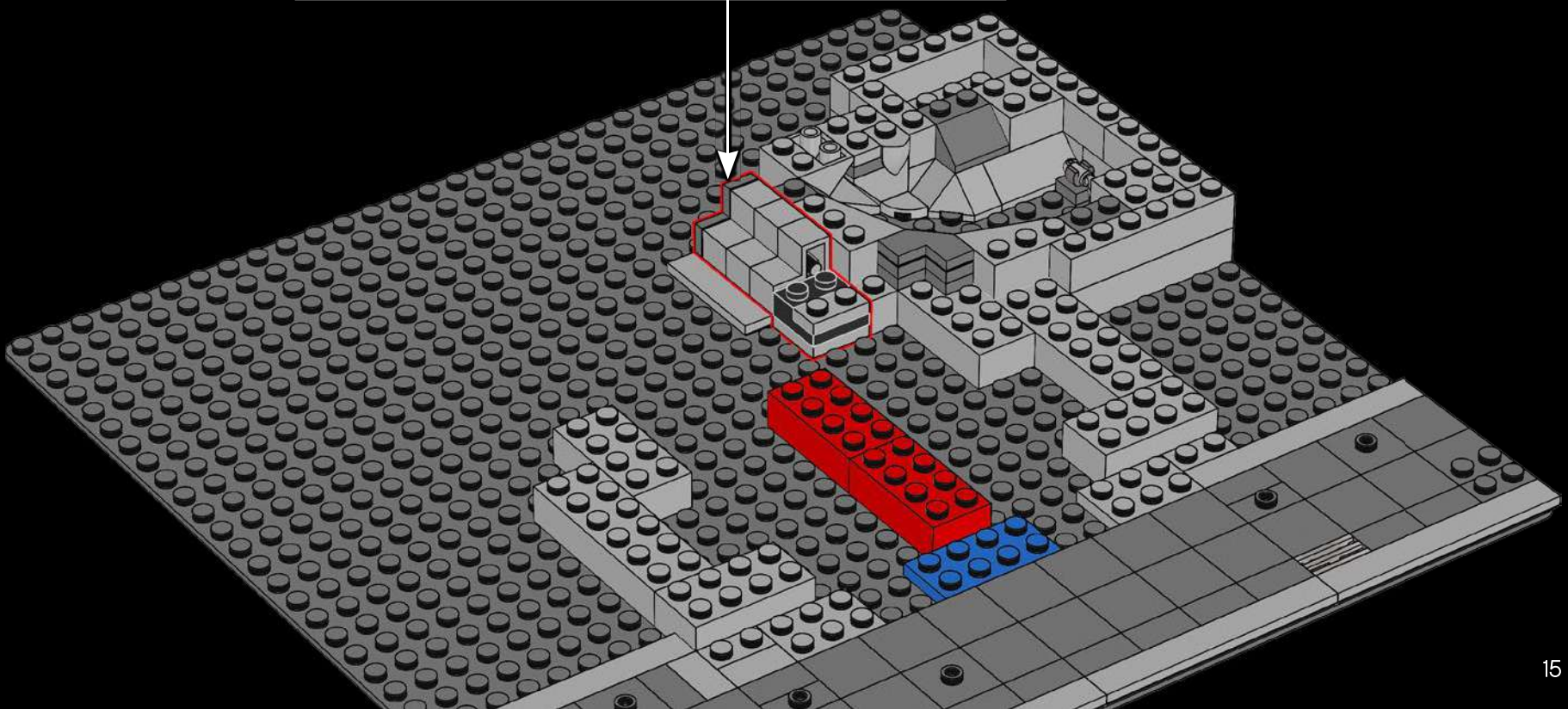
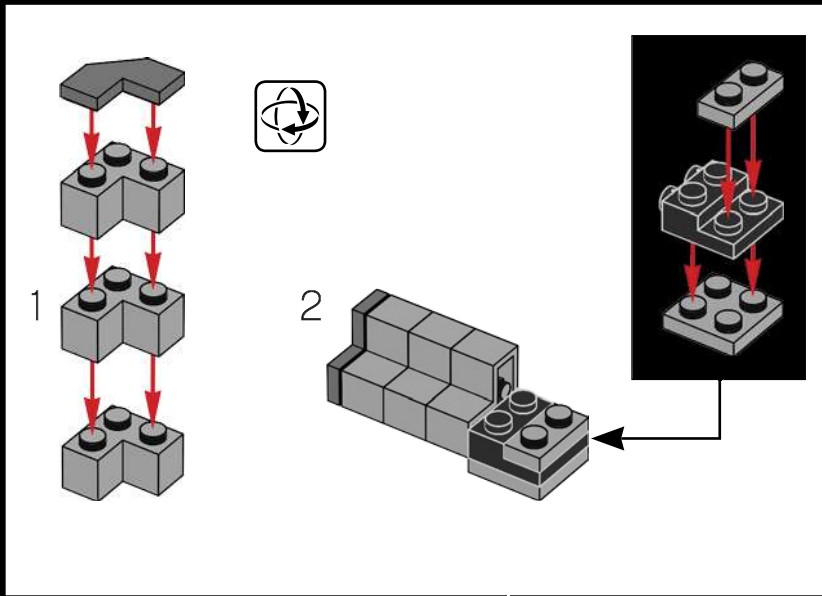

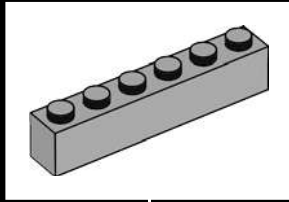
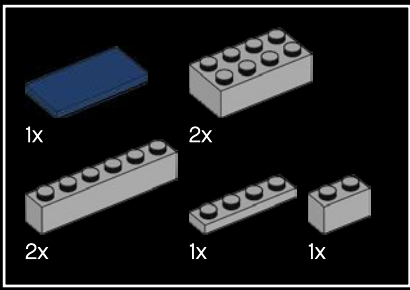

9

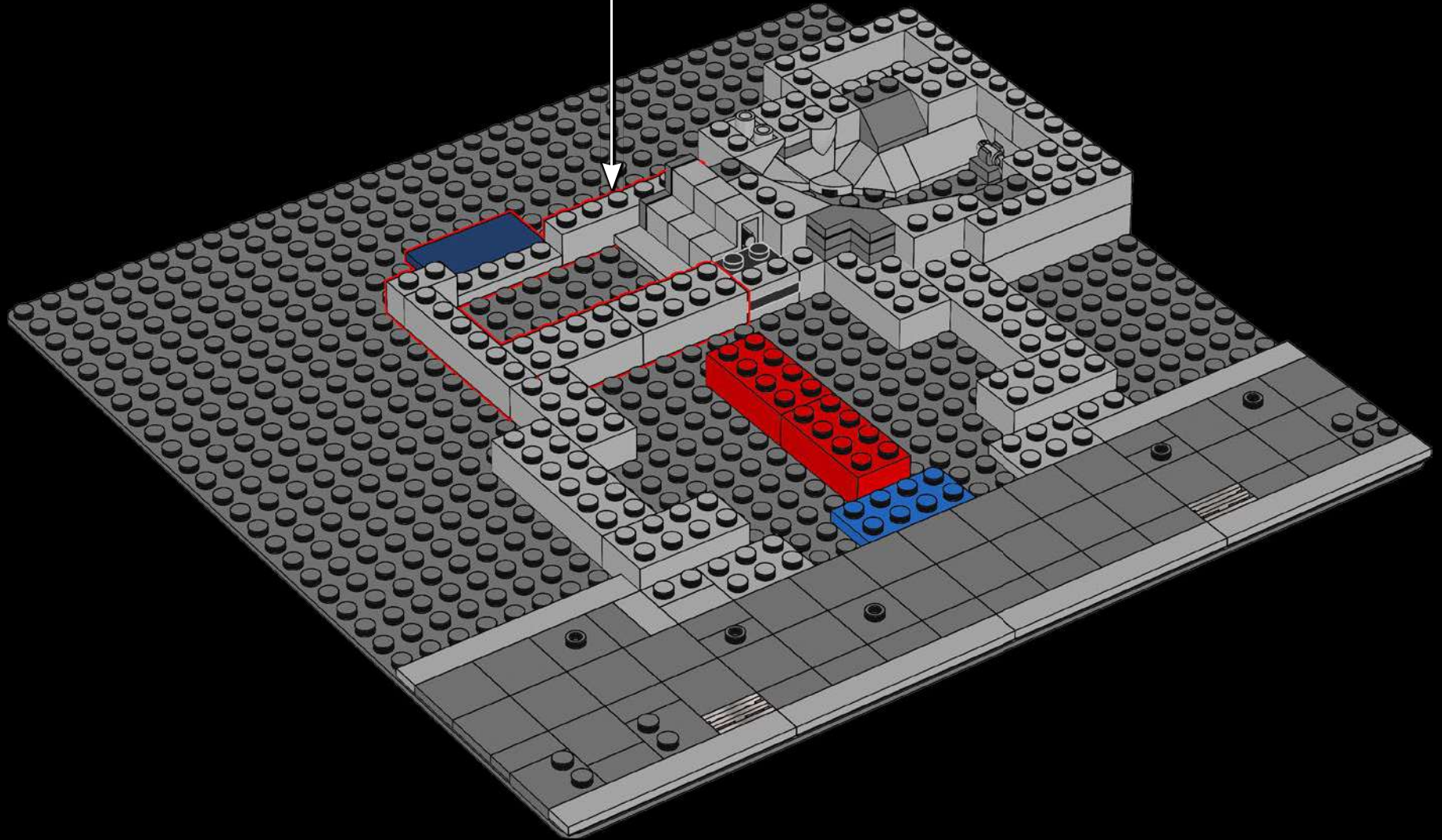

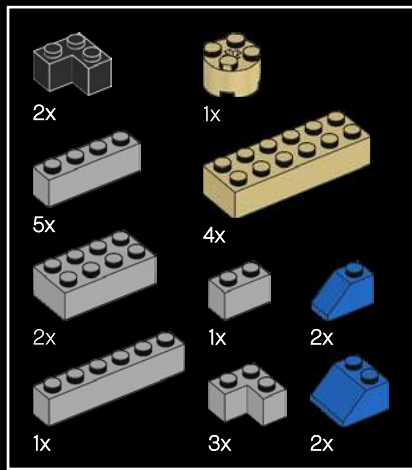

10

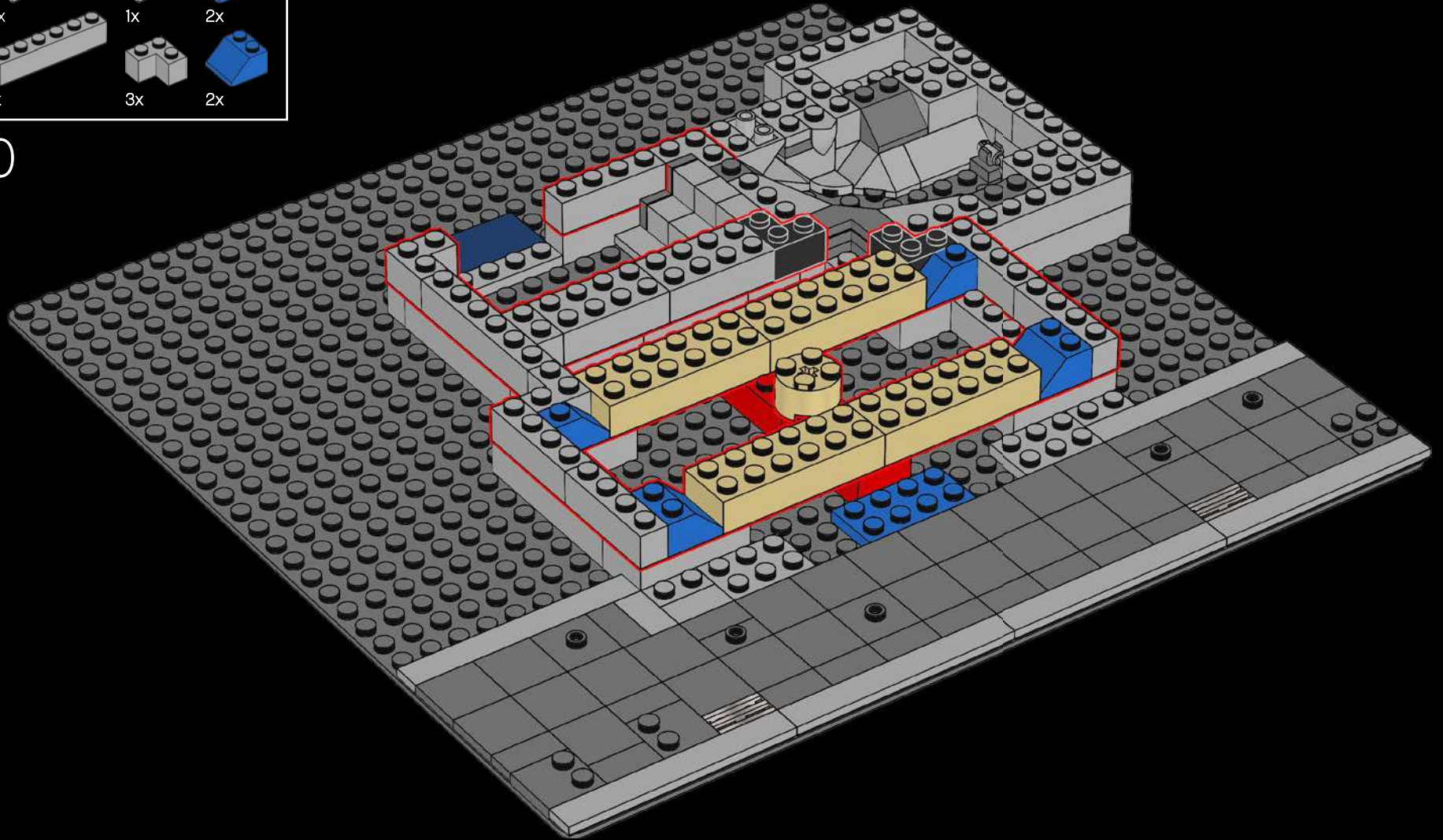

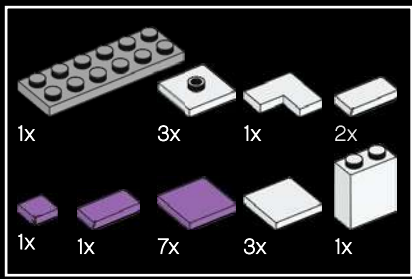

11

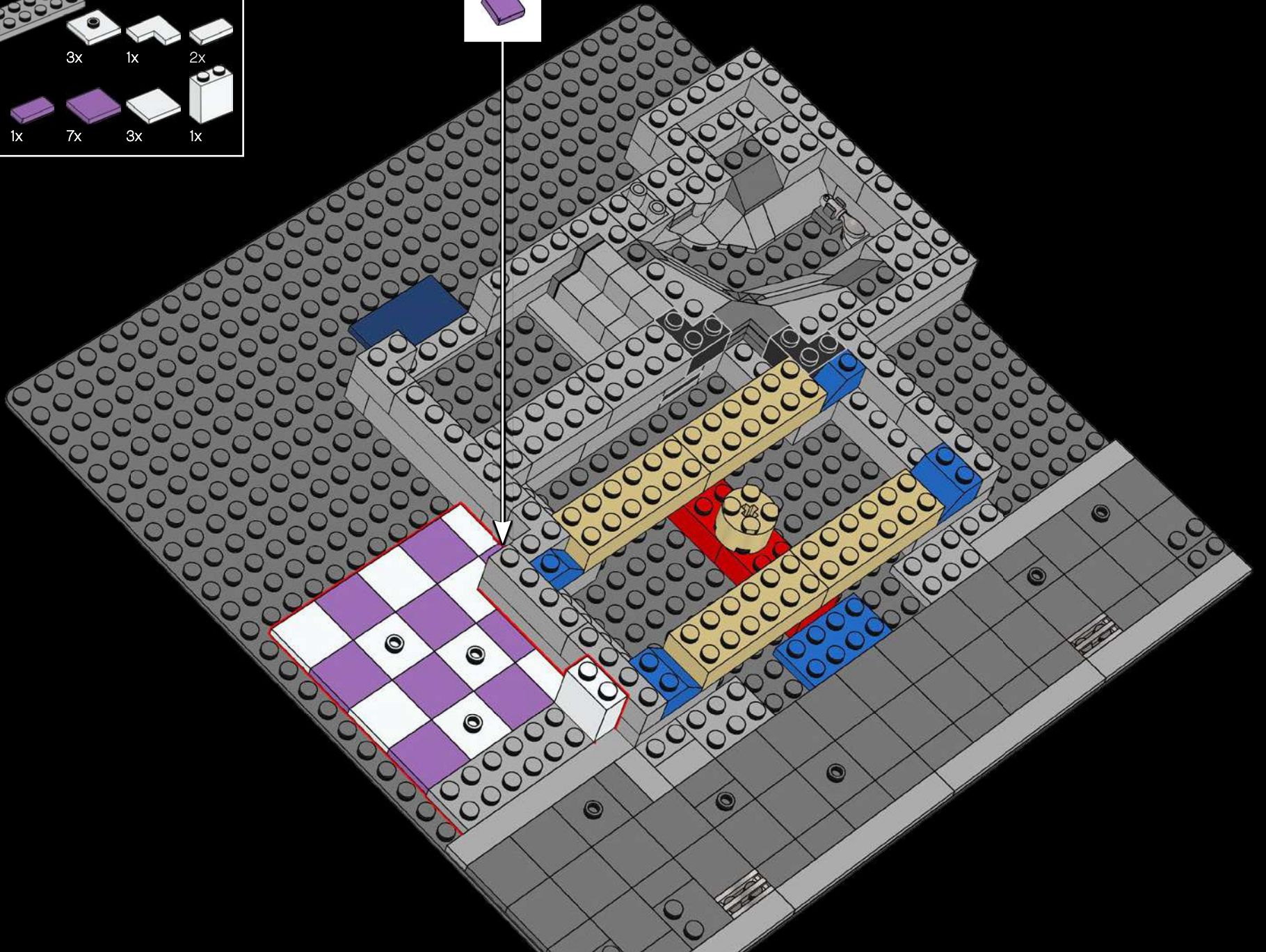

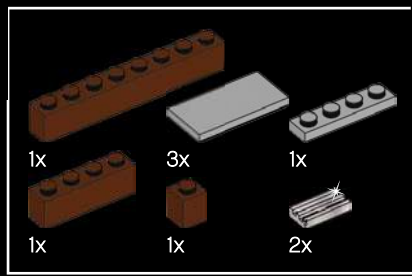

12

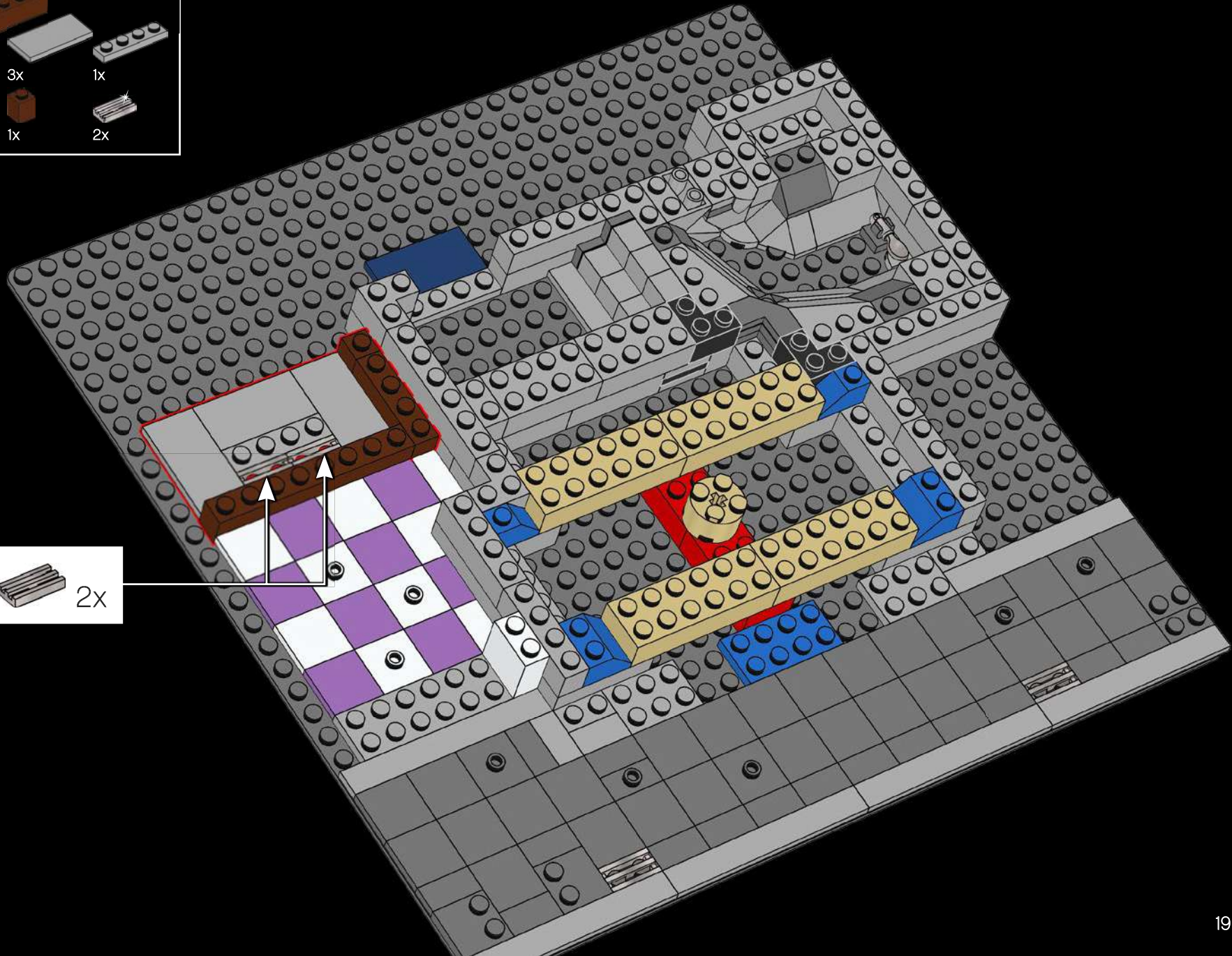

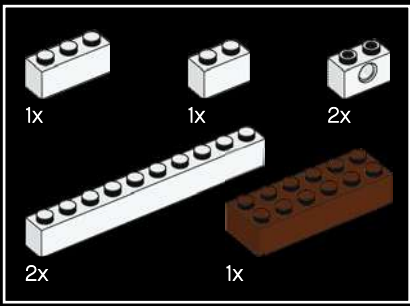

13

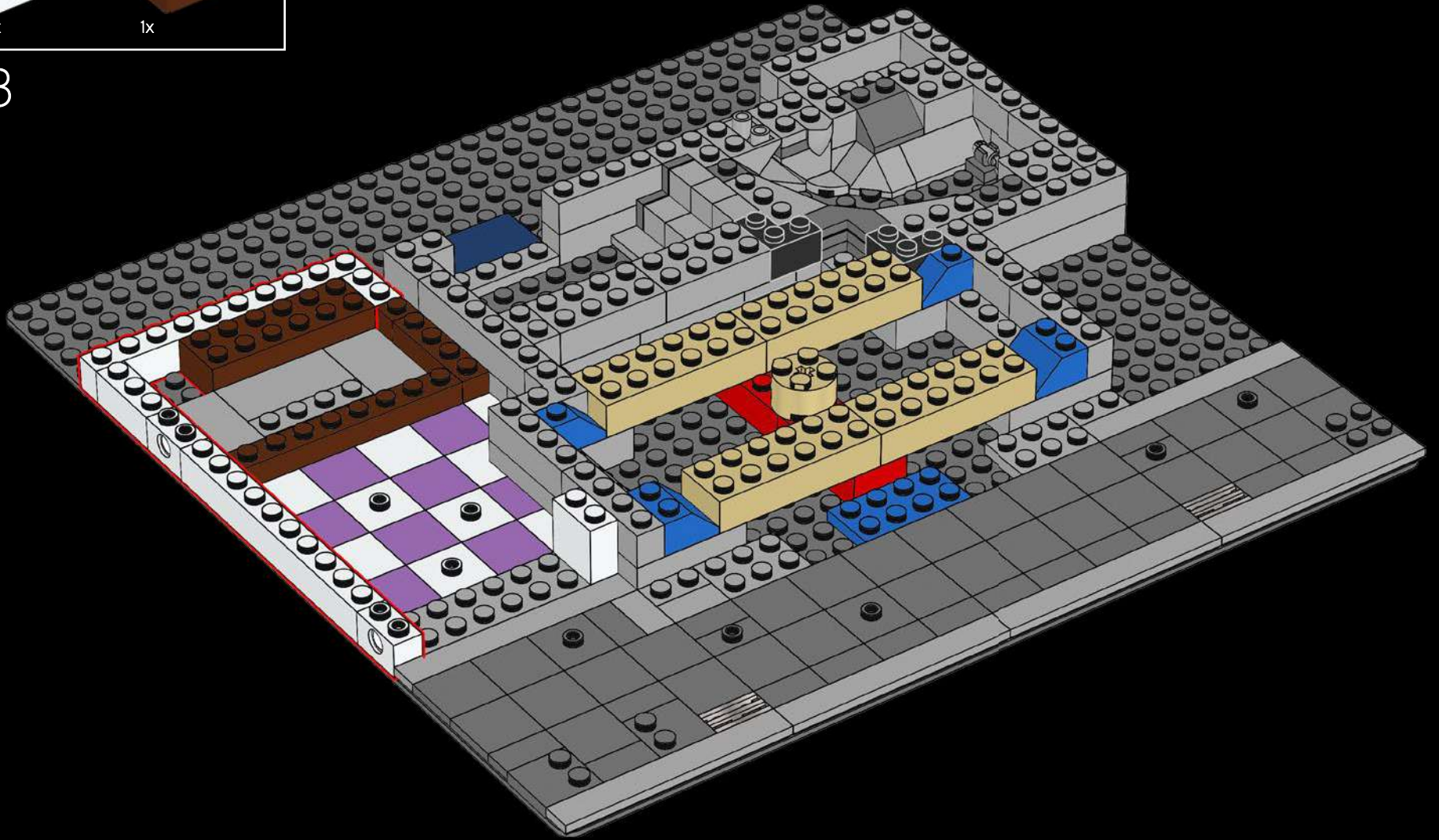

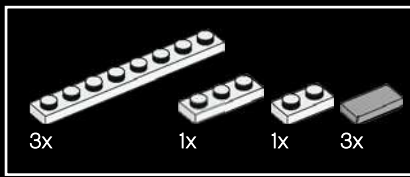

14

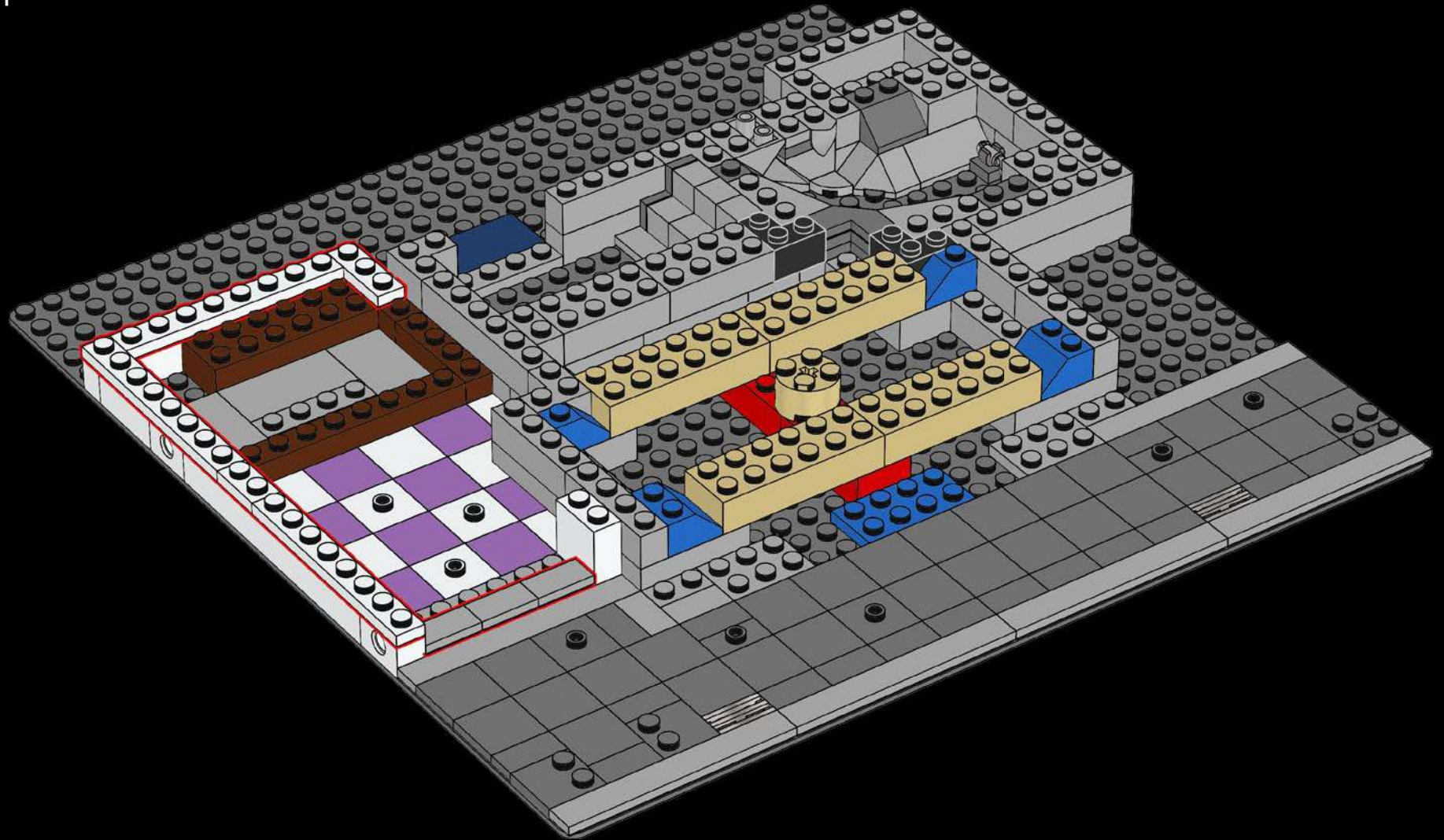

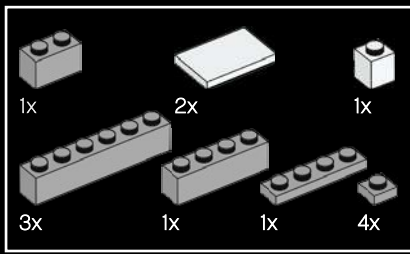

16

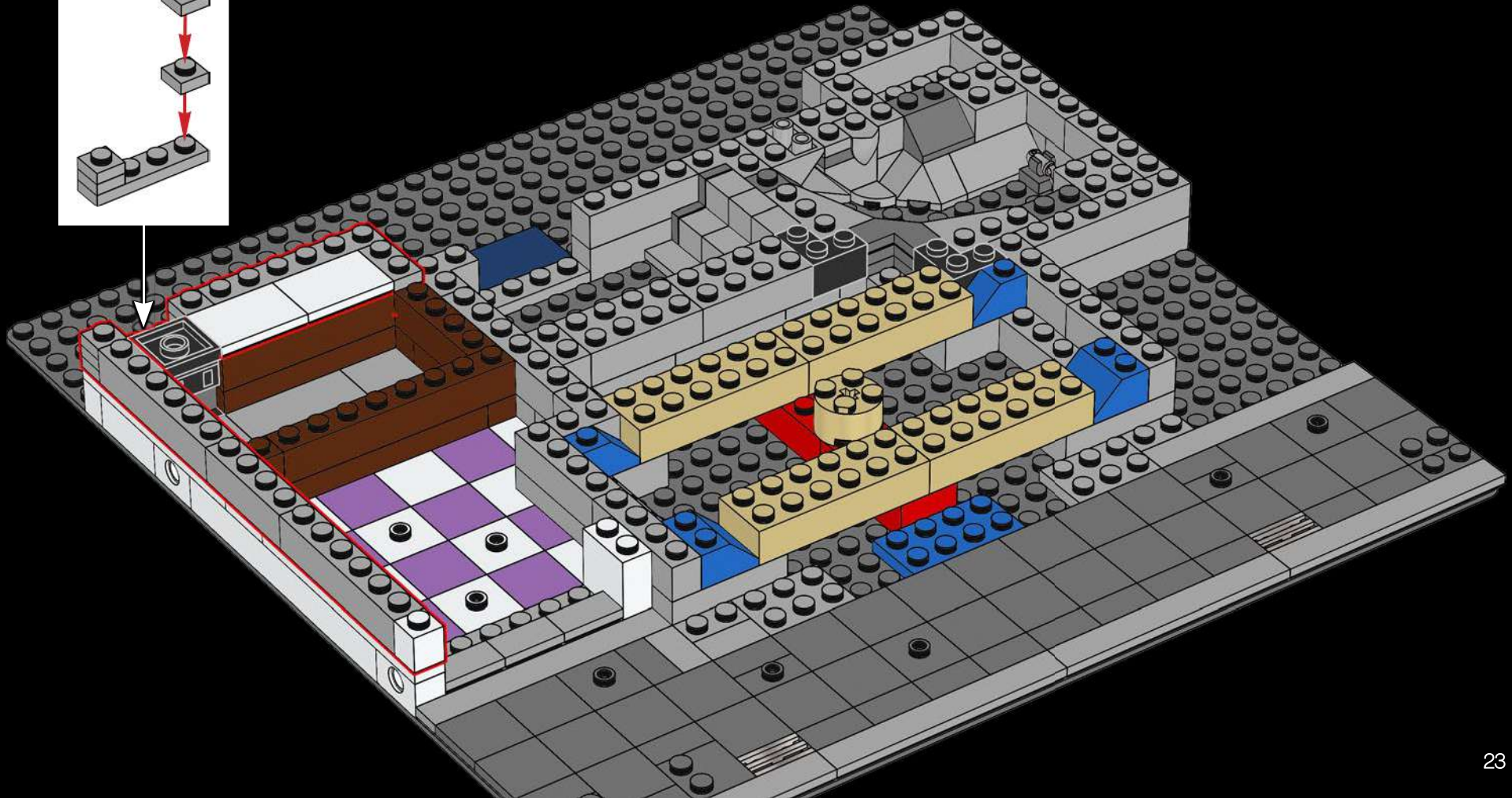
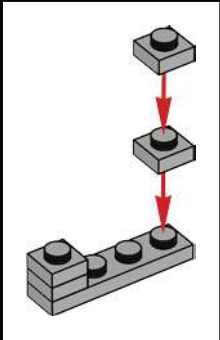

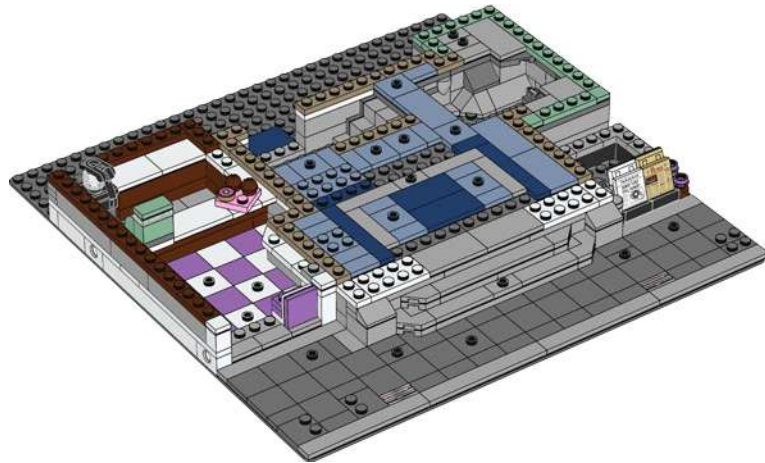

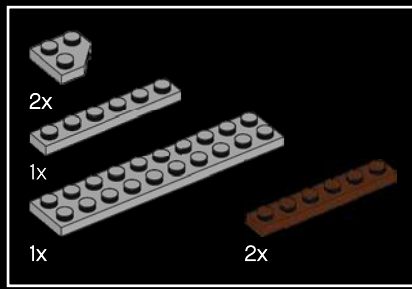

17

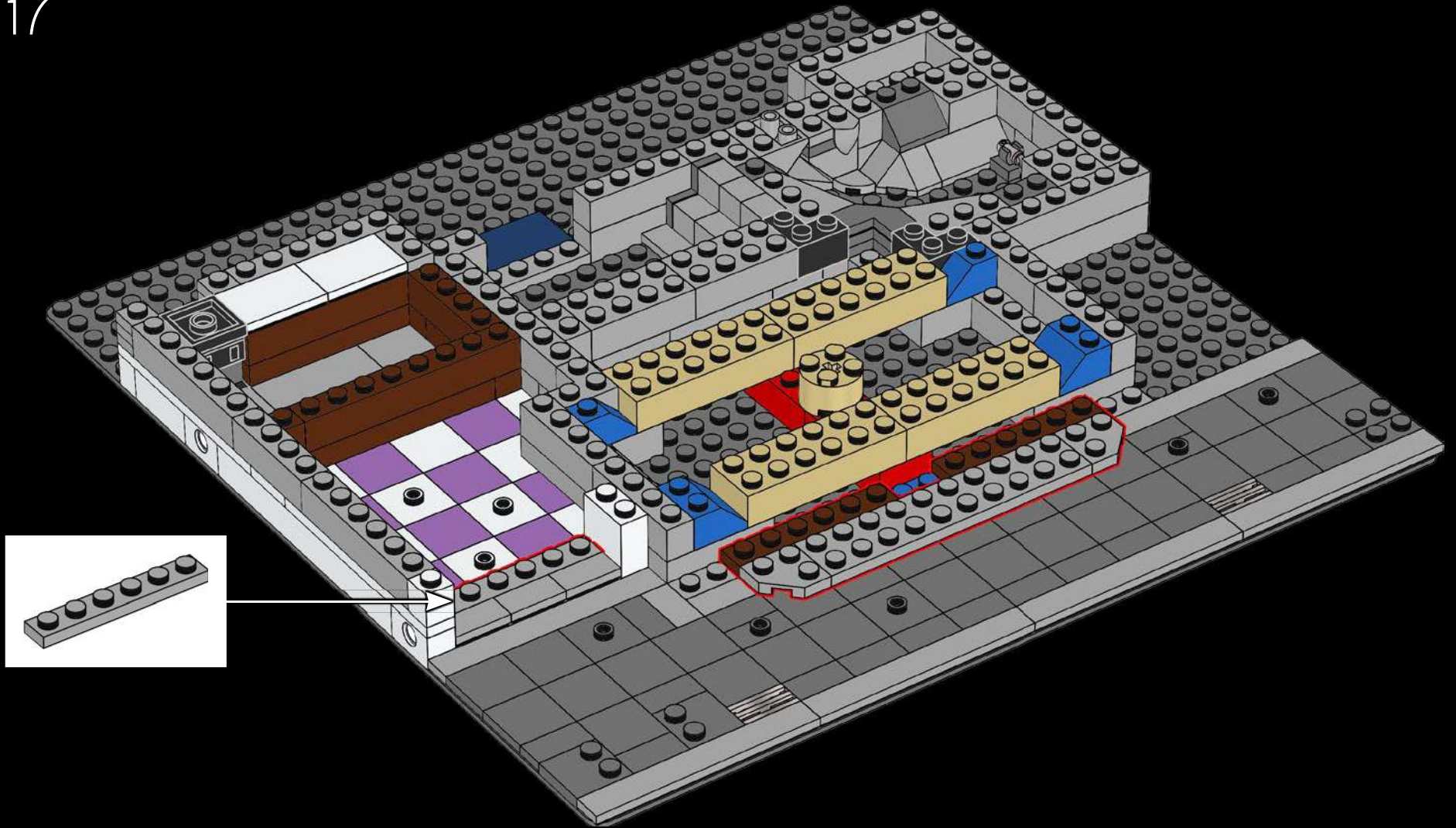

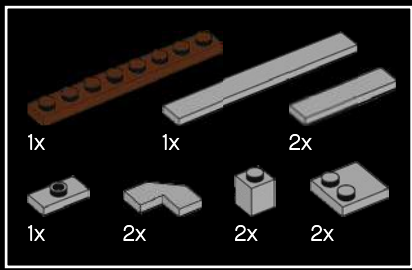

18

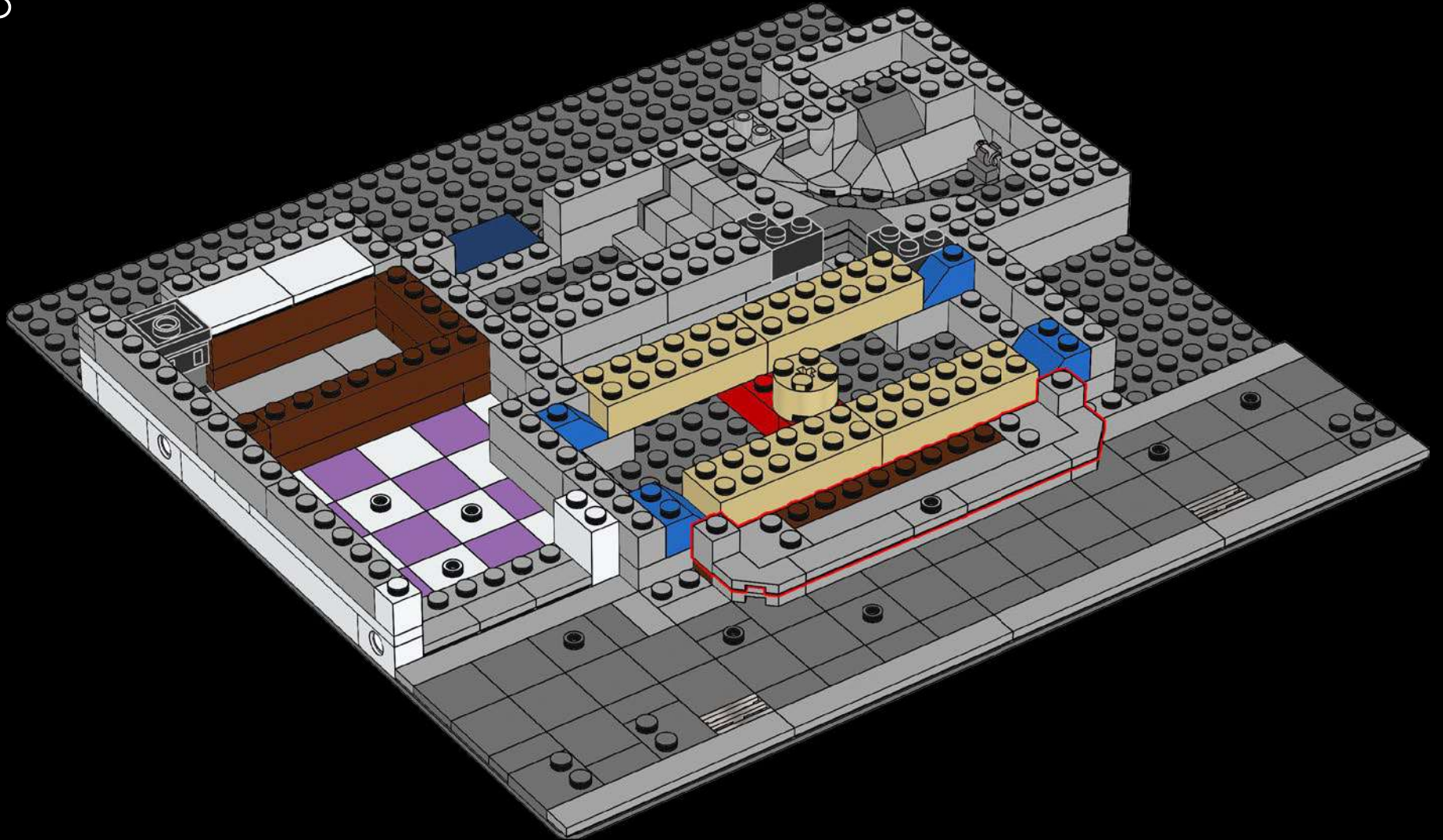

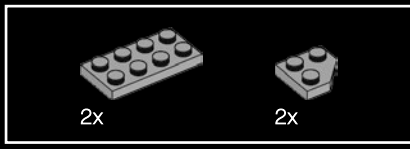

19

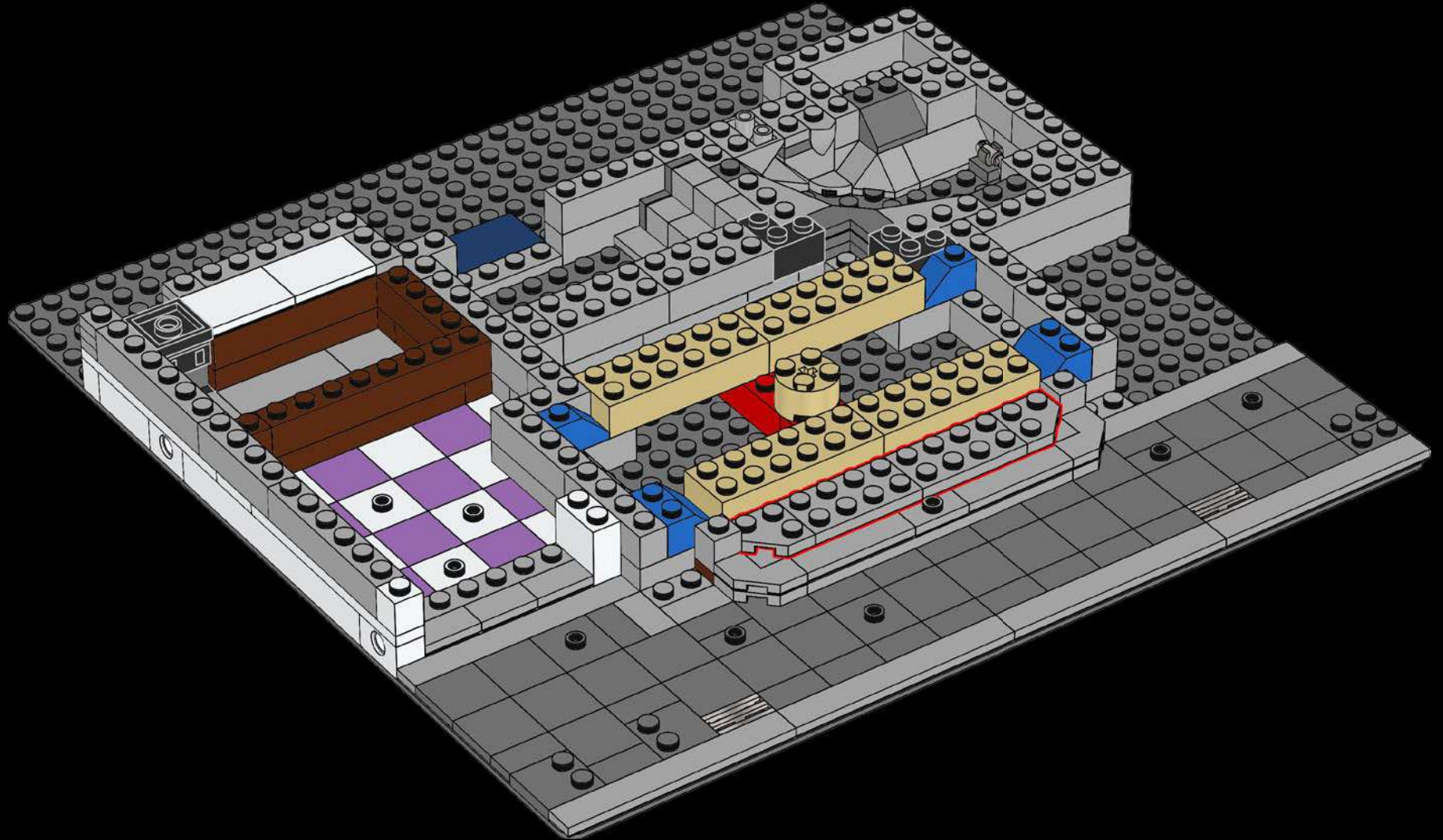

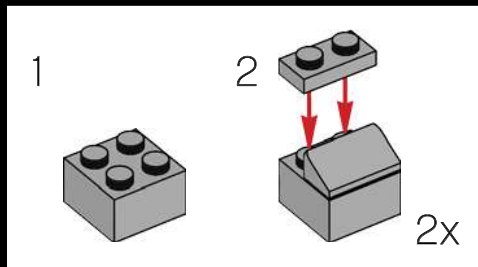
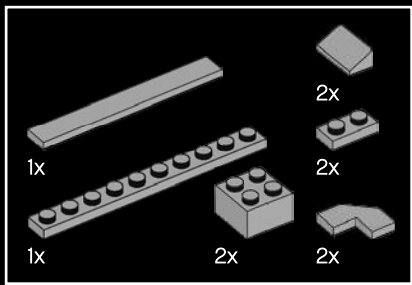

20

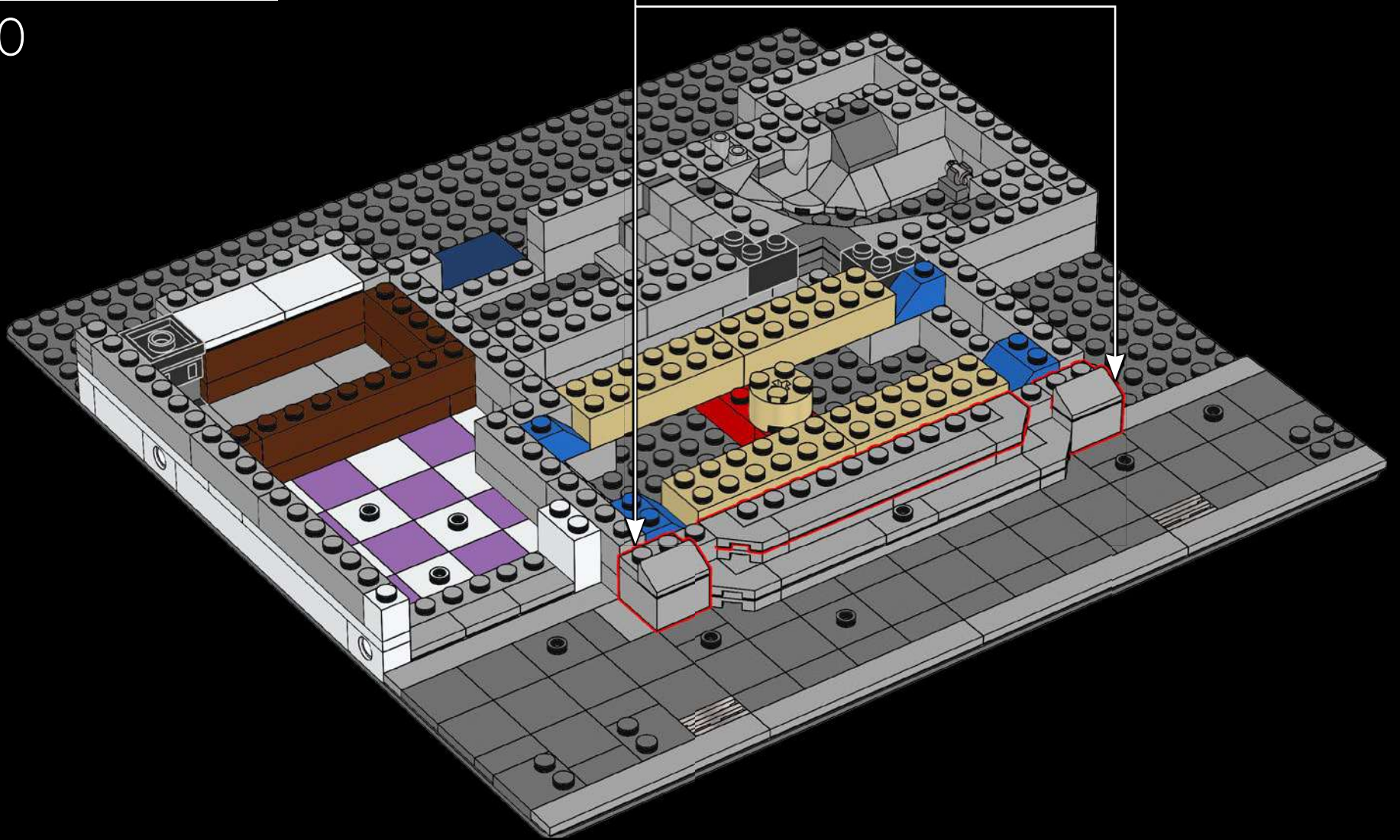

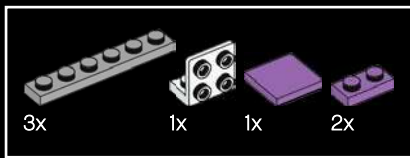

21

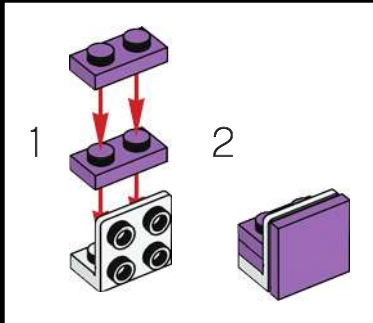
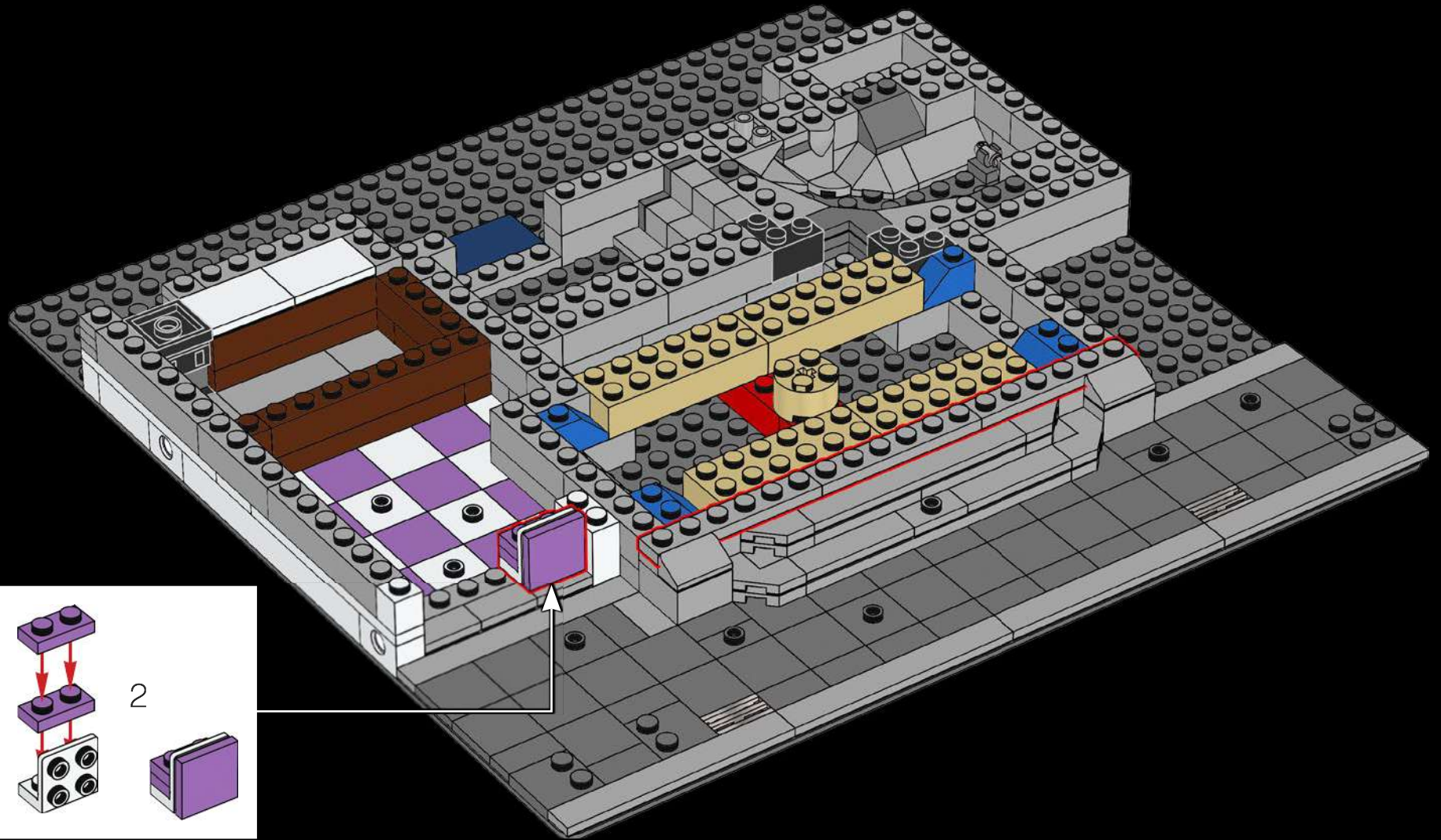

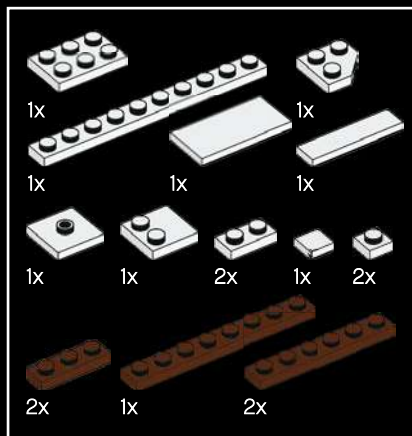

23

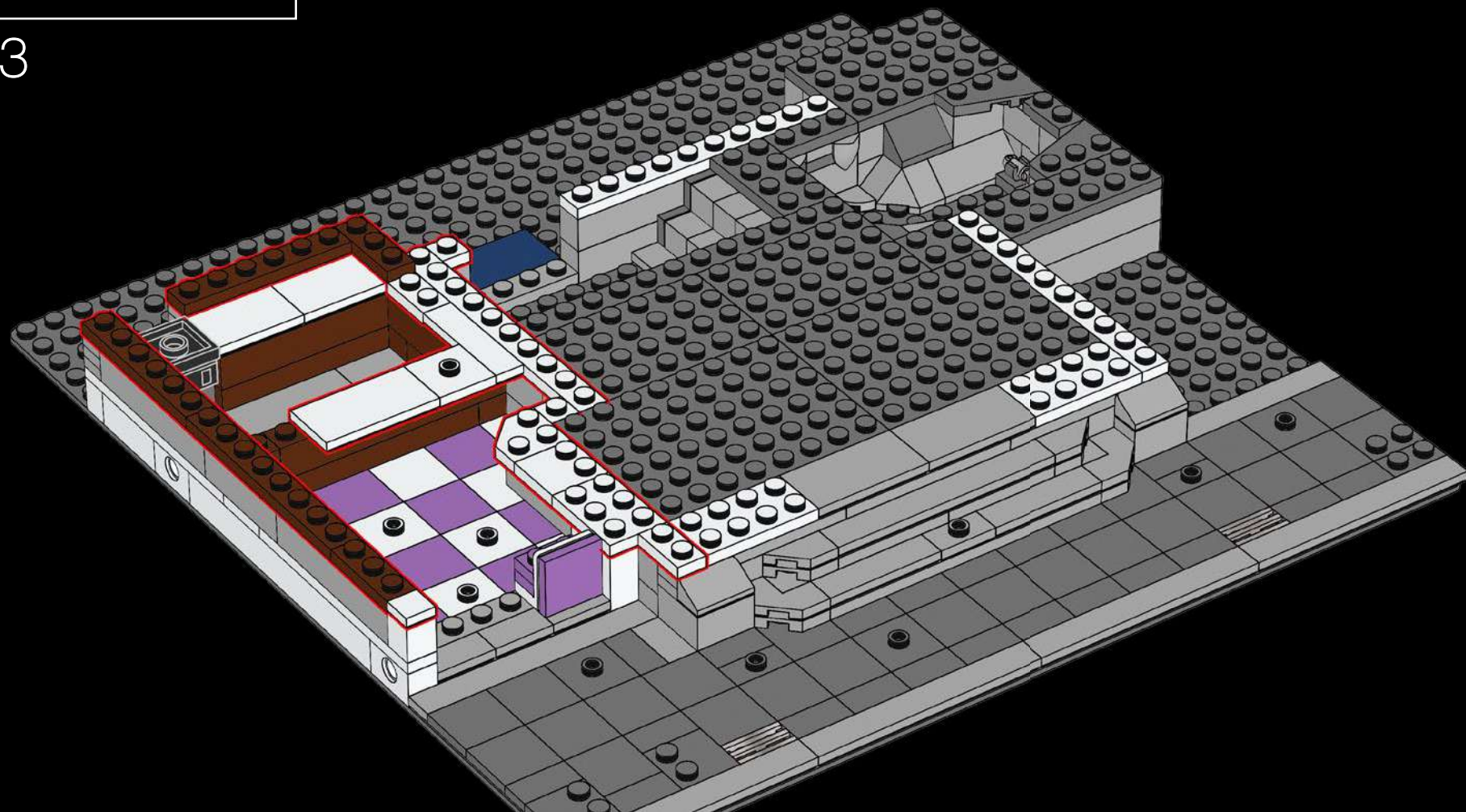

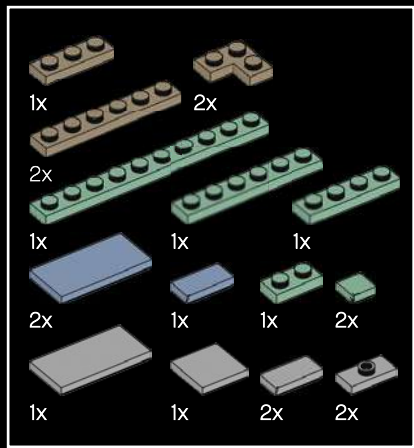

24

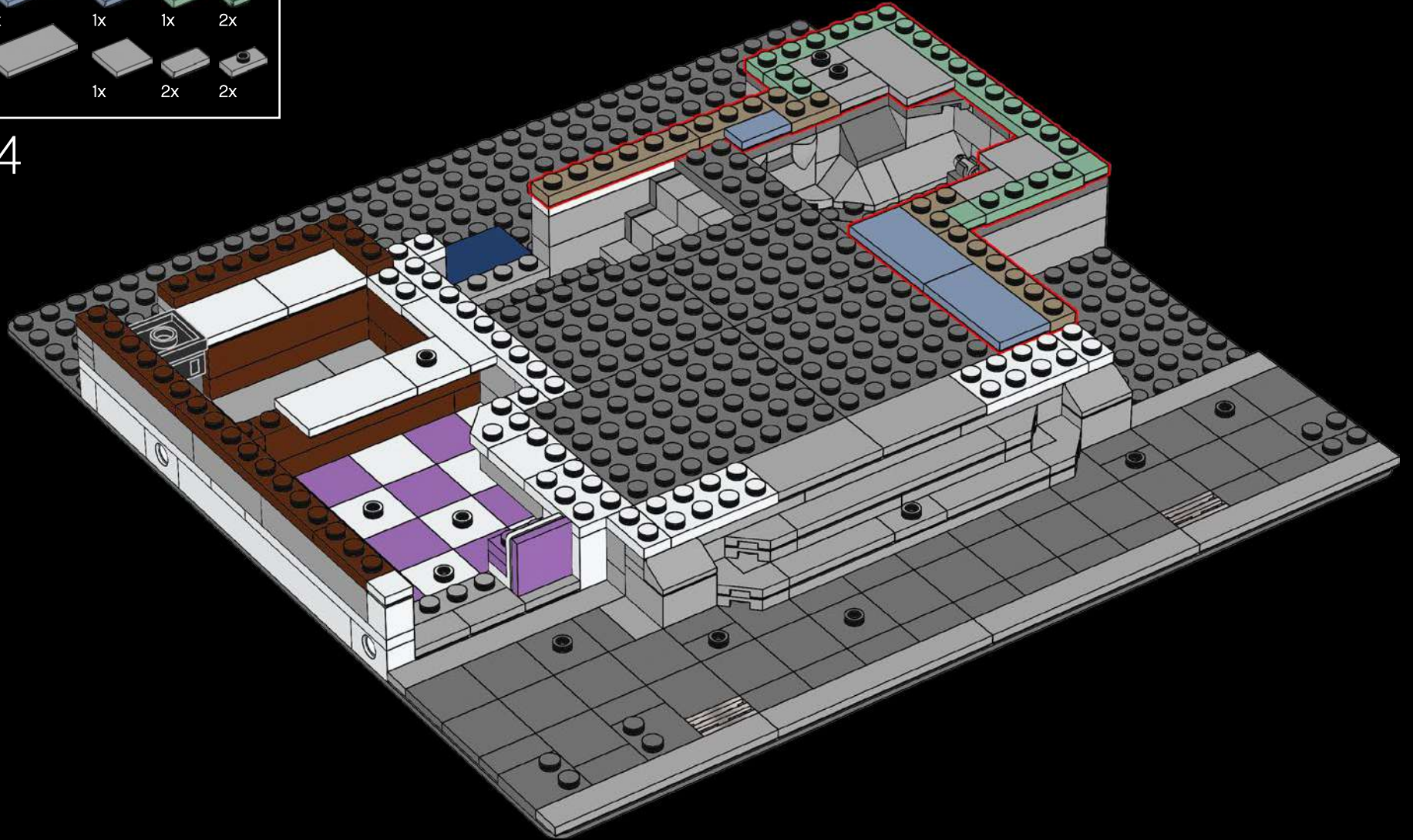

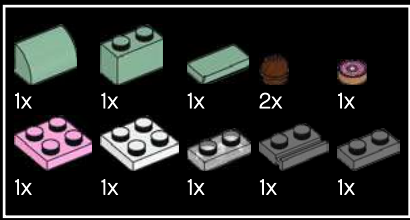

26

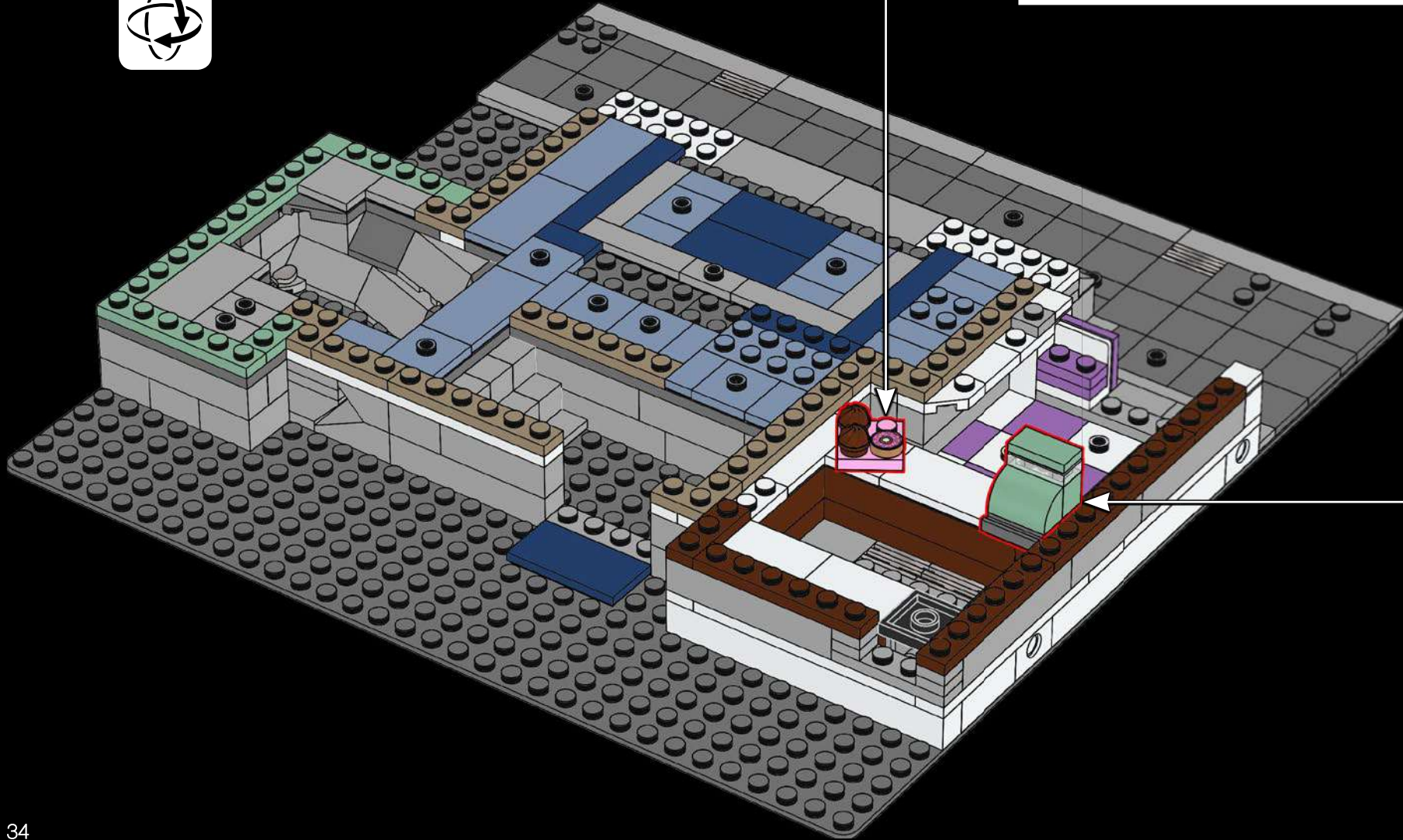
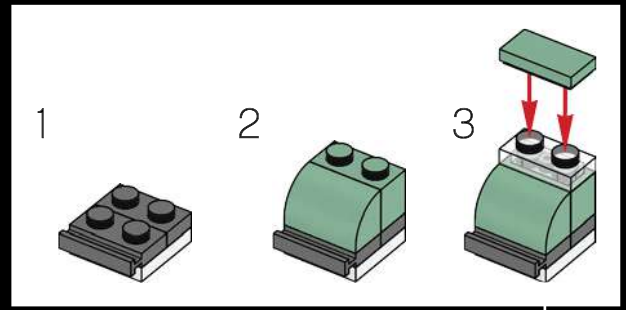
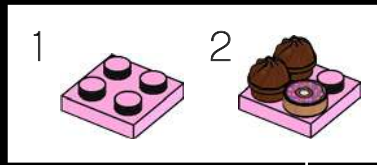

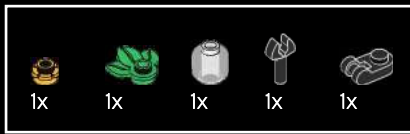

27

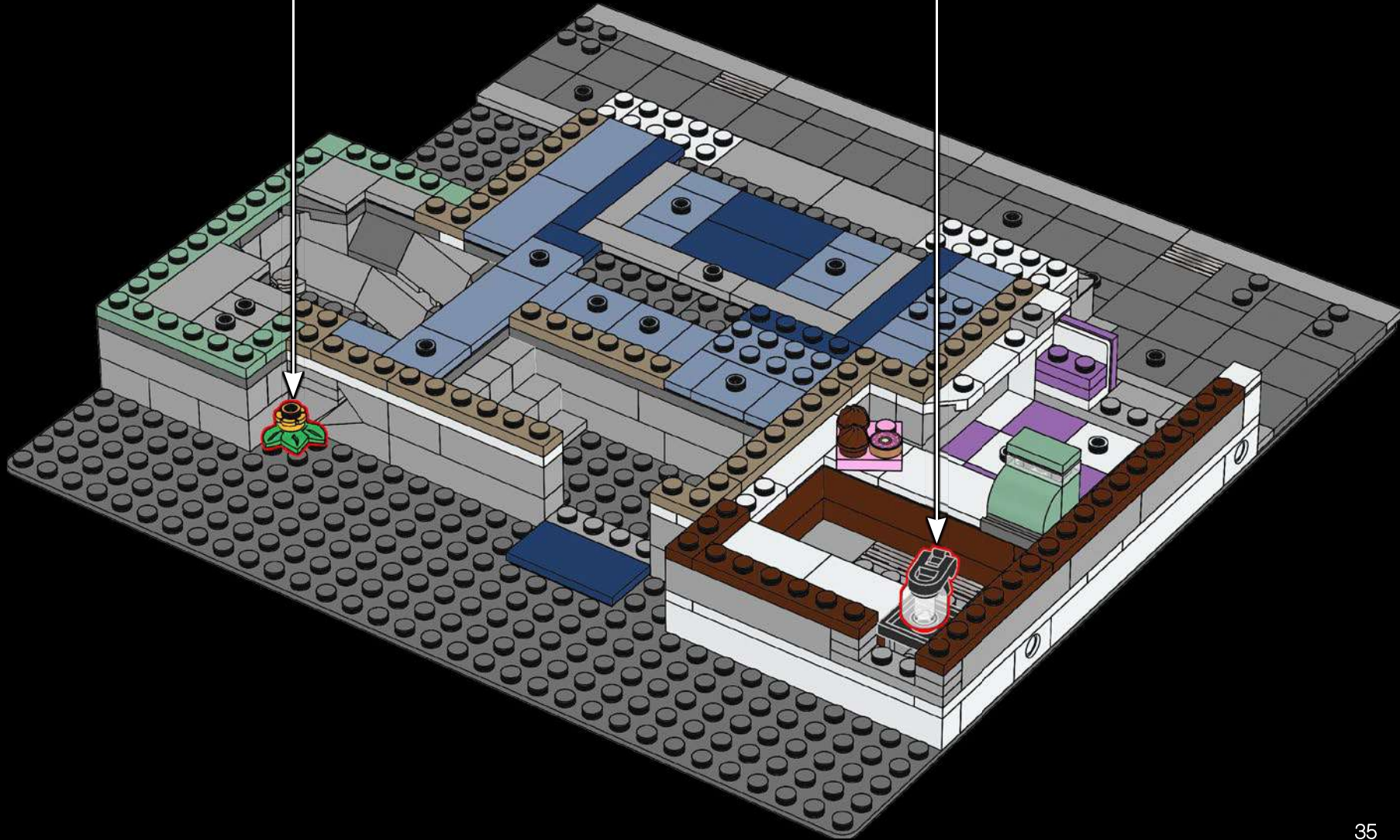
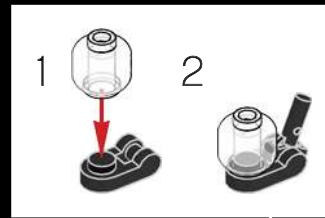
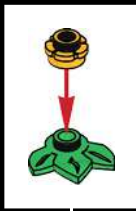

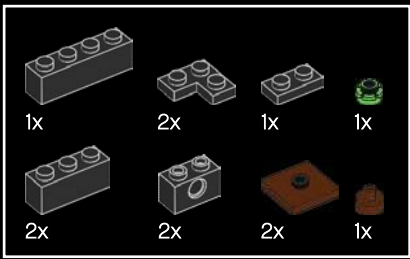



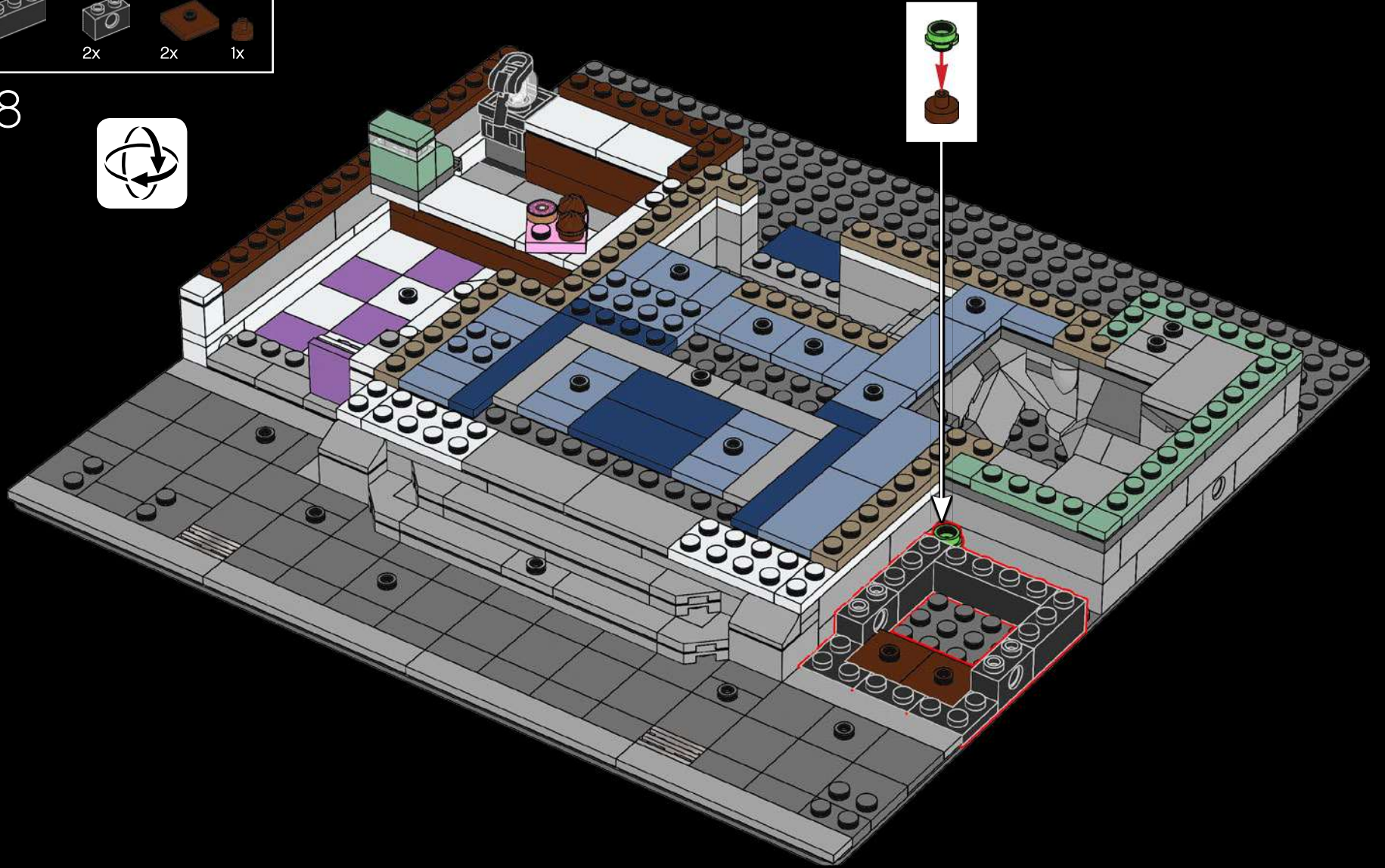

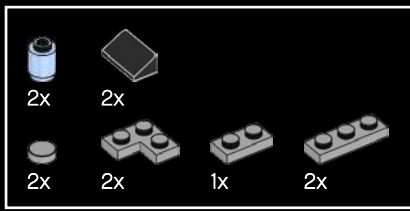

28

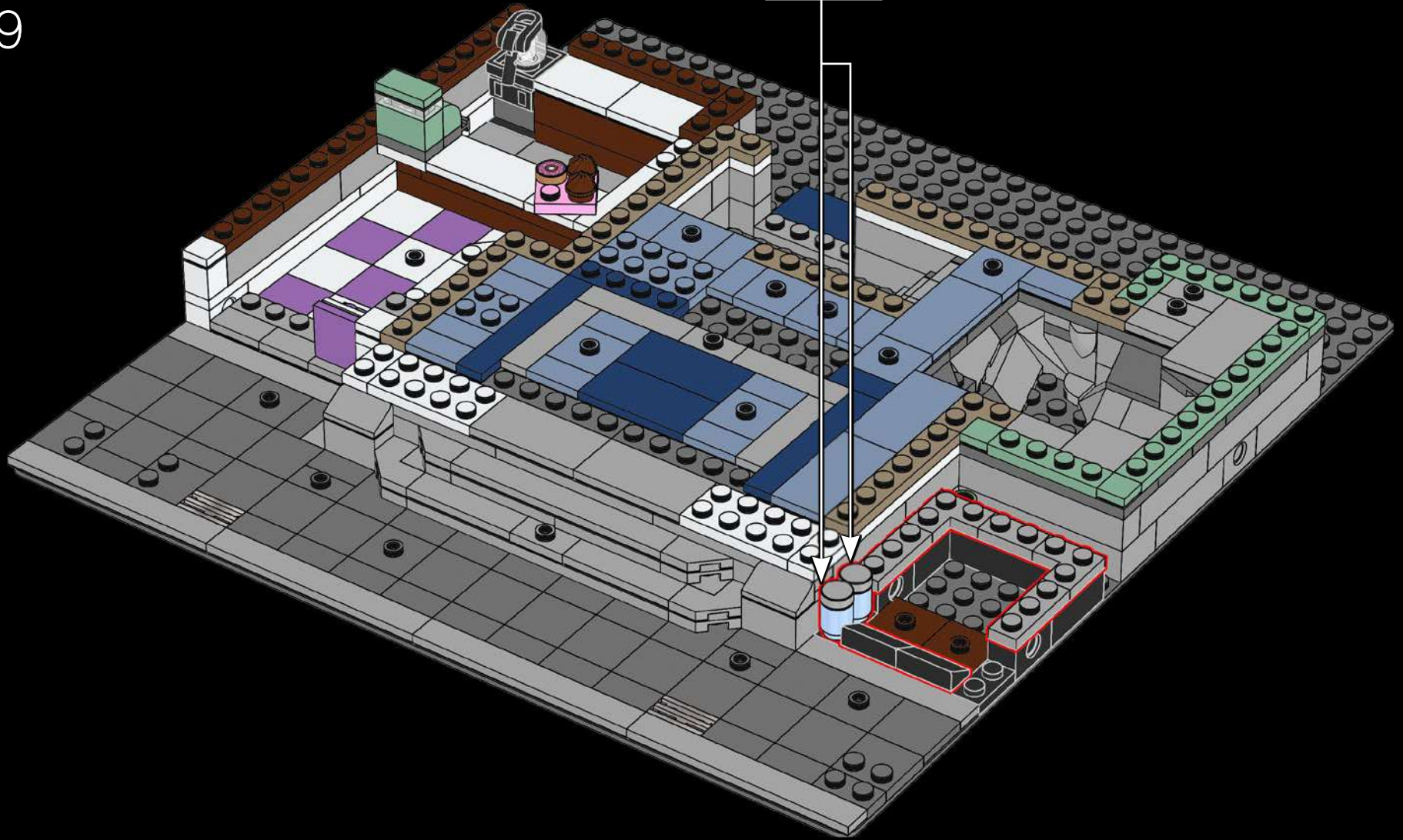
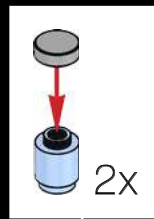



29



- 
2x
- 
2x
- 
1x
- 
2x
- 
1x

30

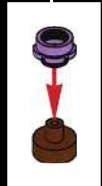
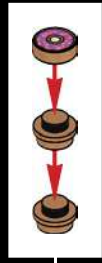
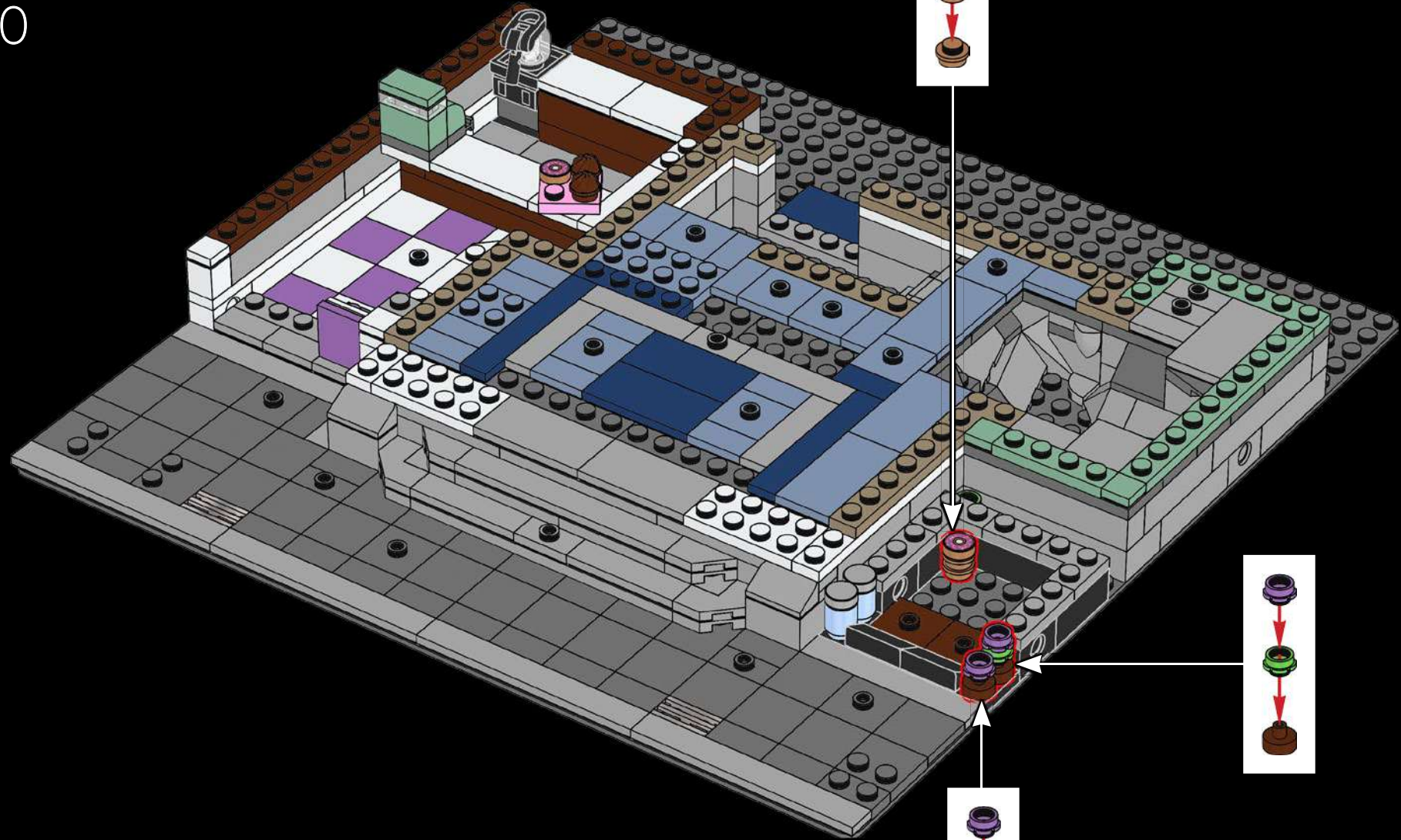

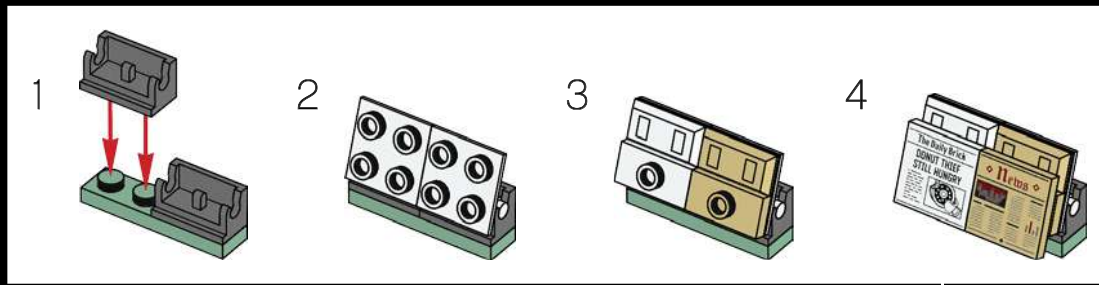
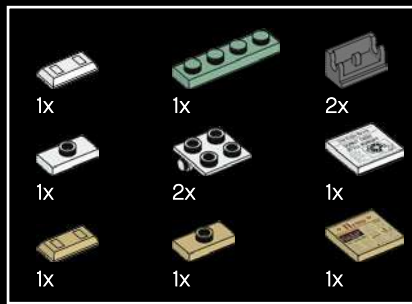

31



Our good-natured shop owner runs the delicious doughnut shop.

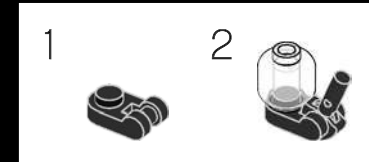
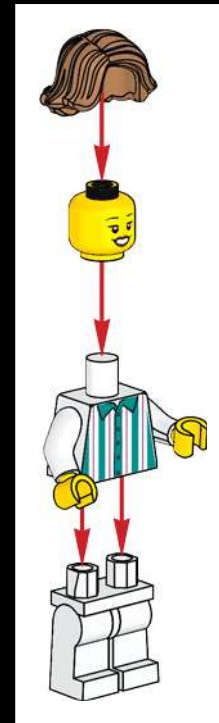
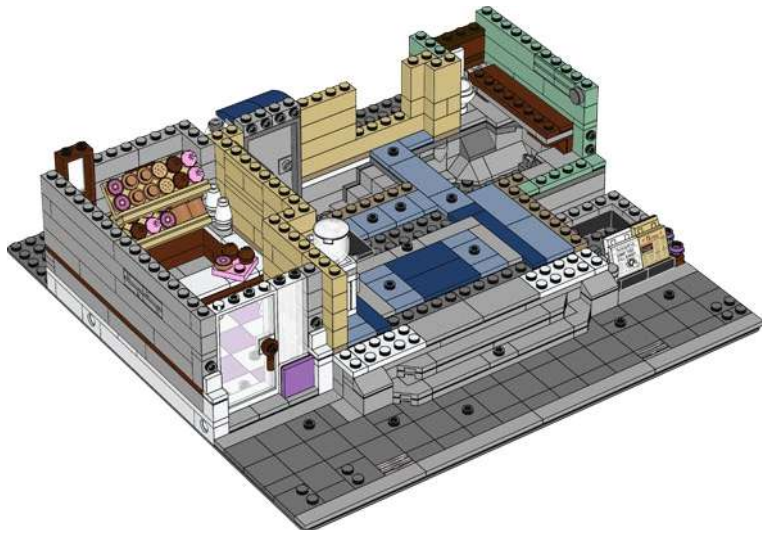

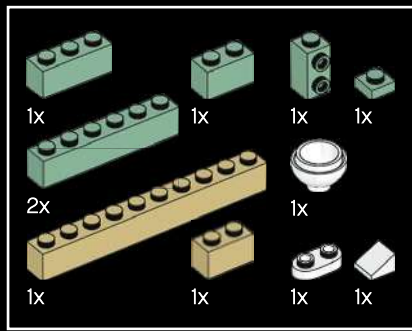

32

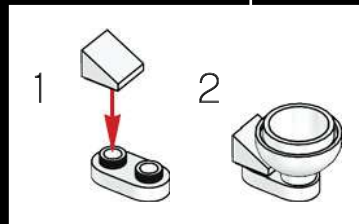
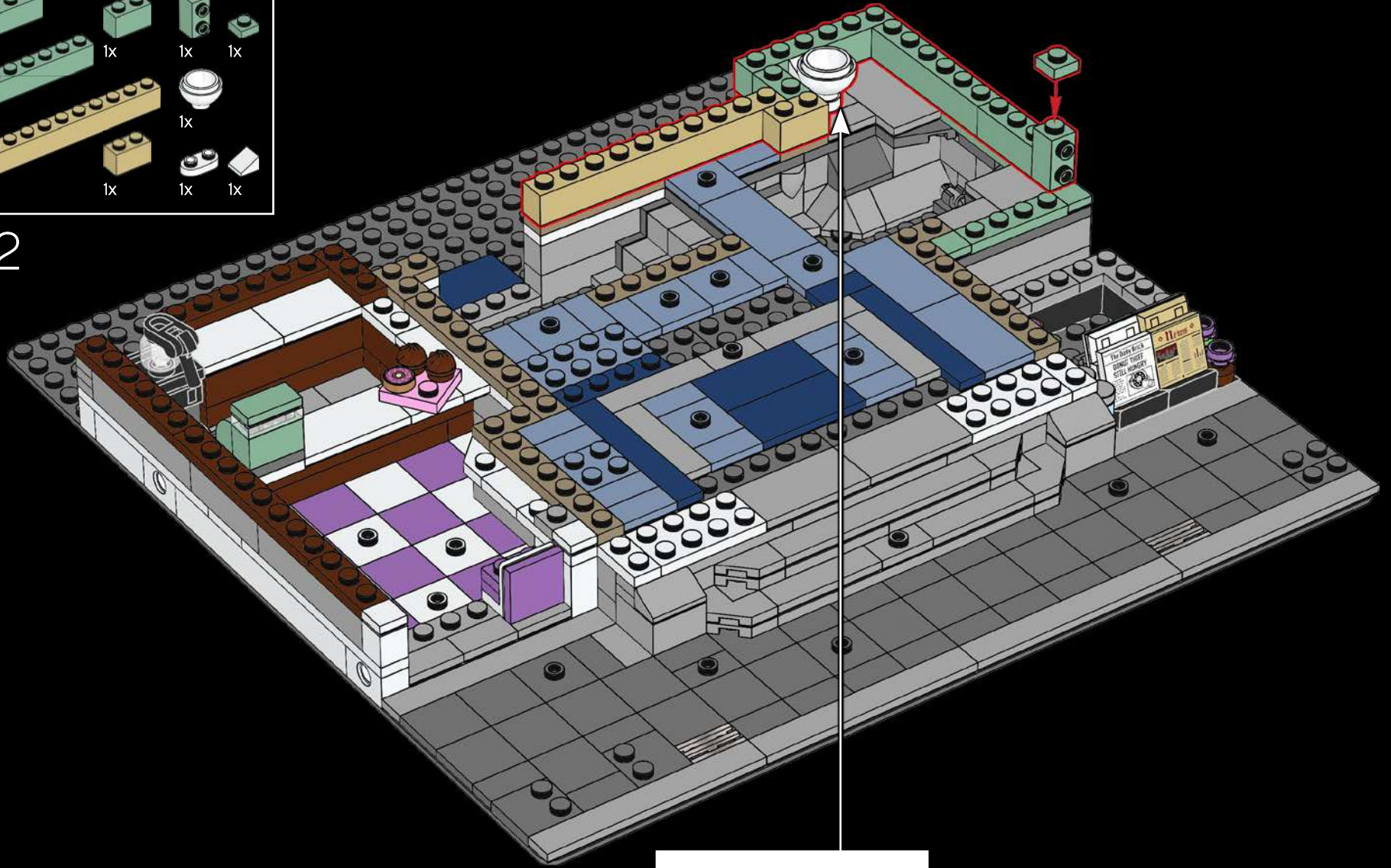

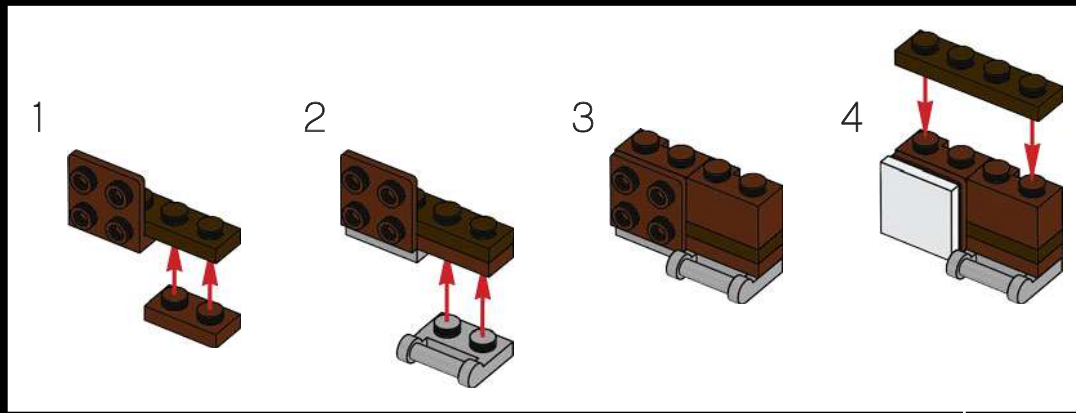
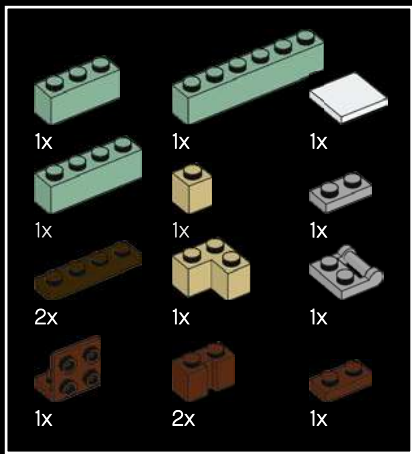

33

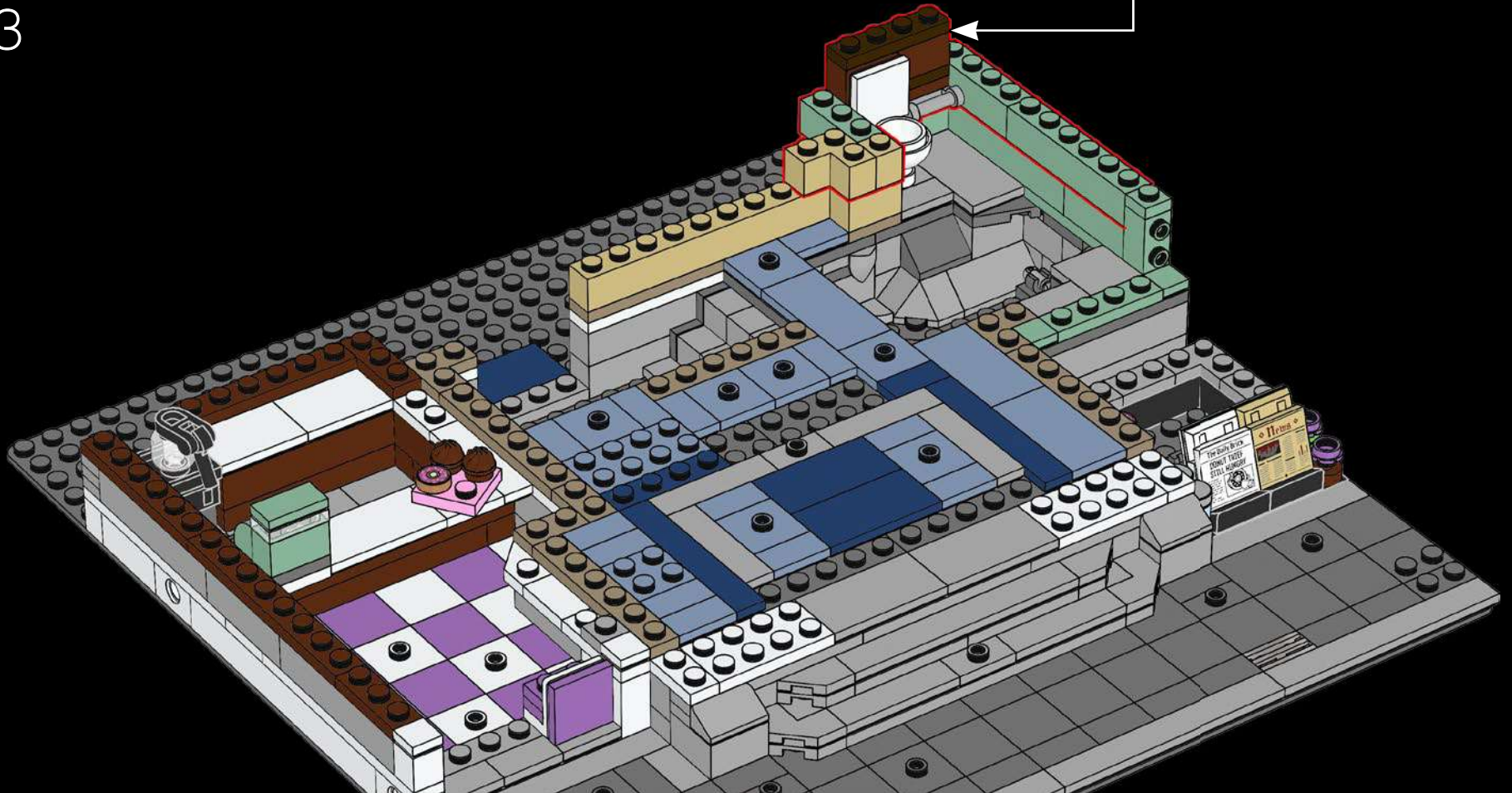

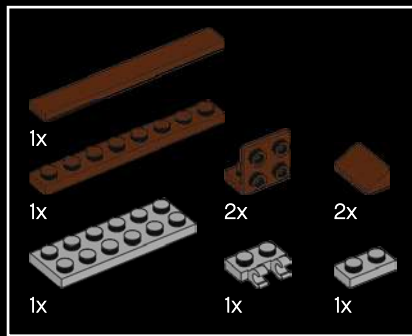

34

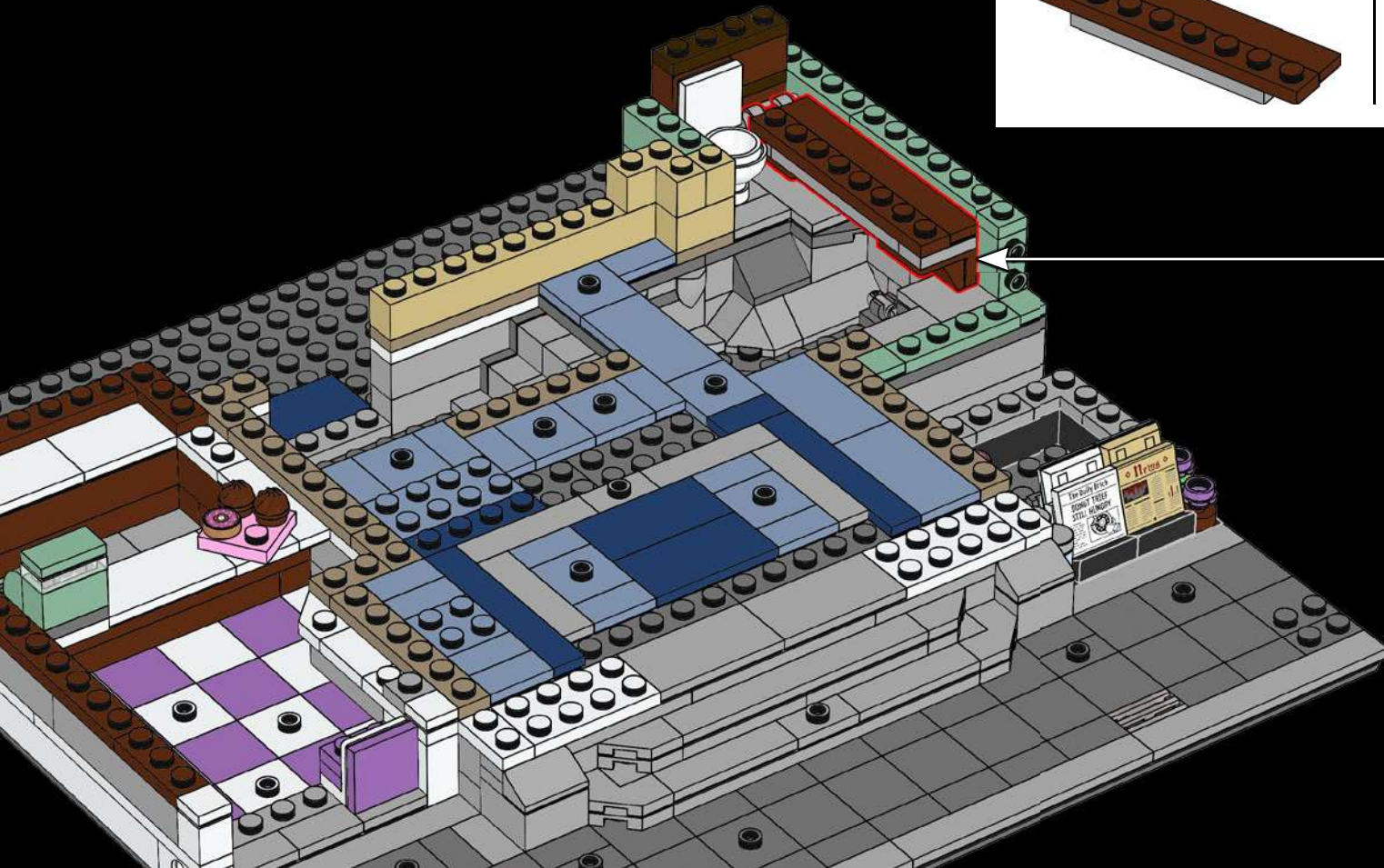
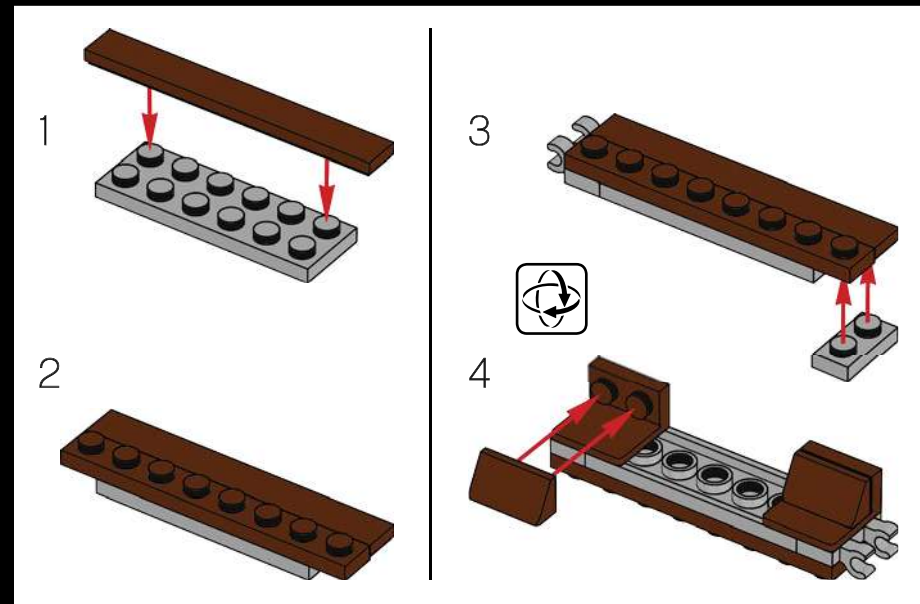

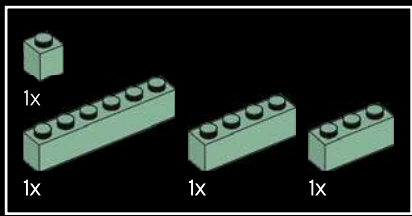

35



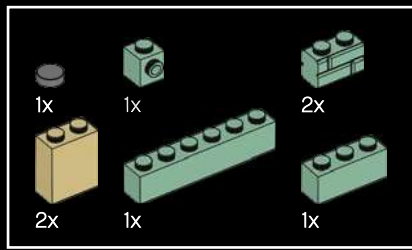

36

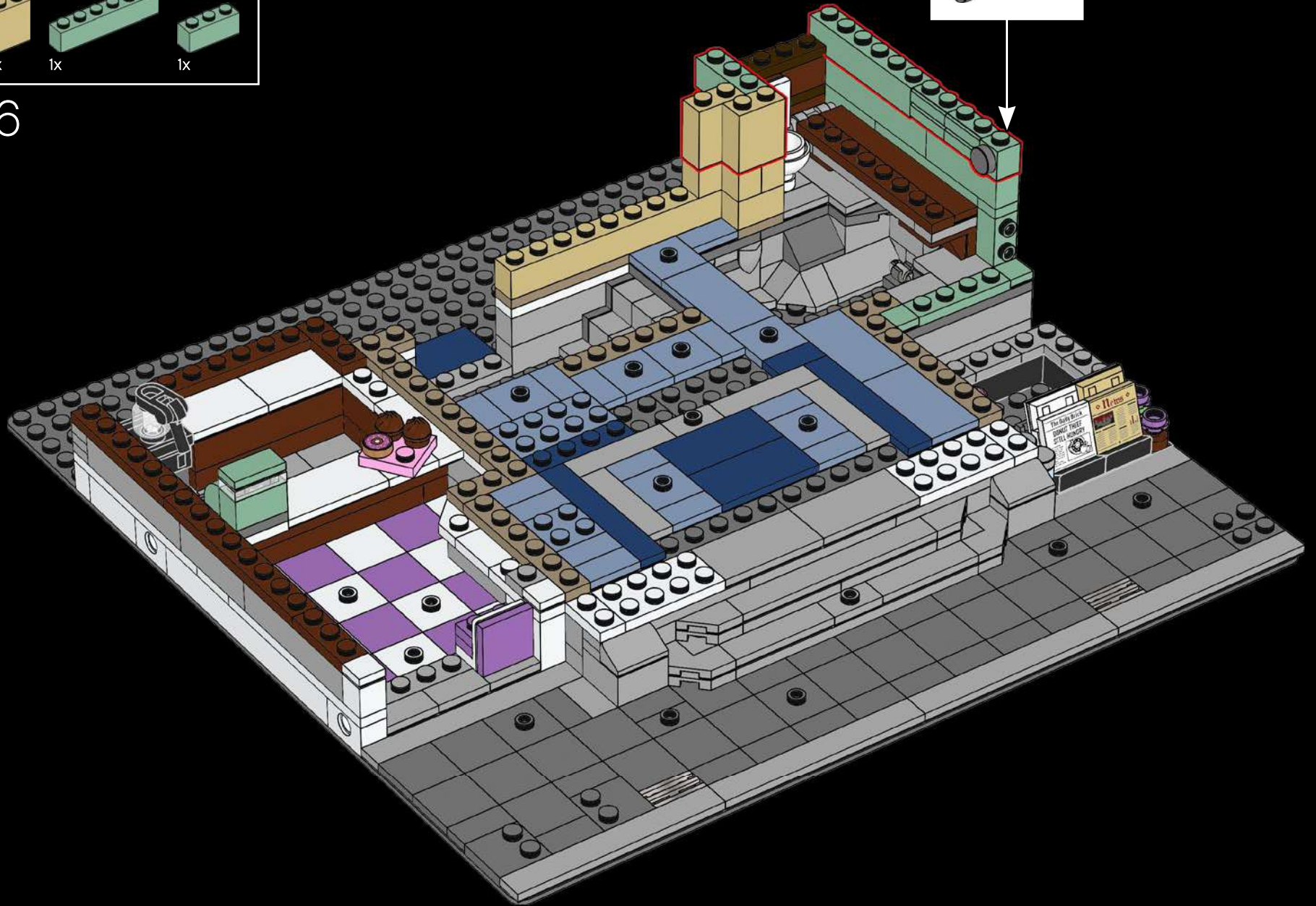
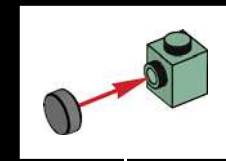

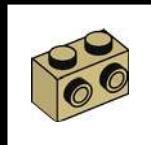
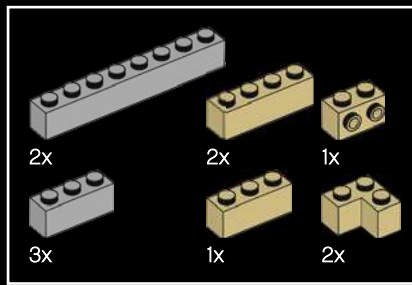

38

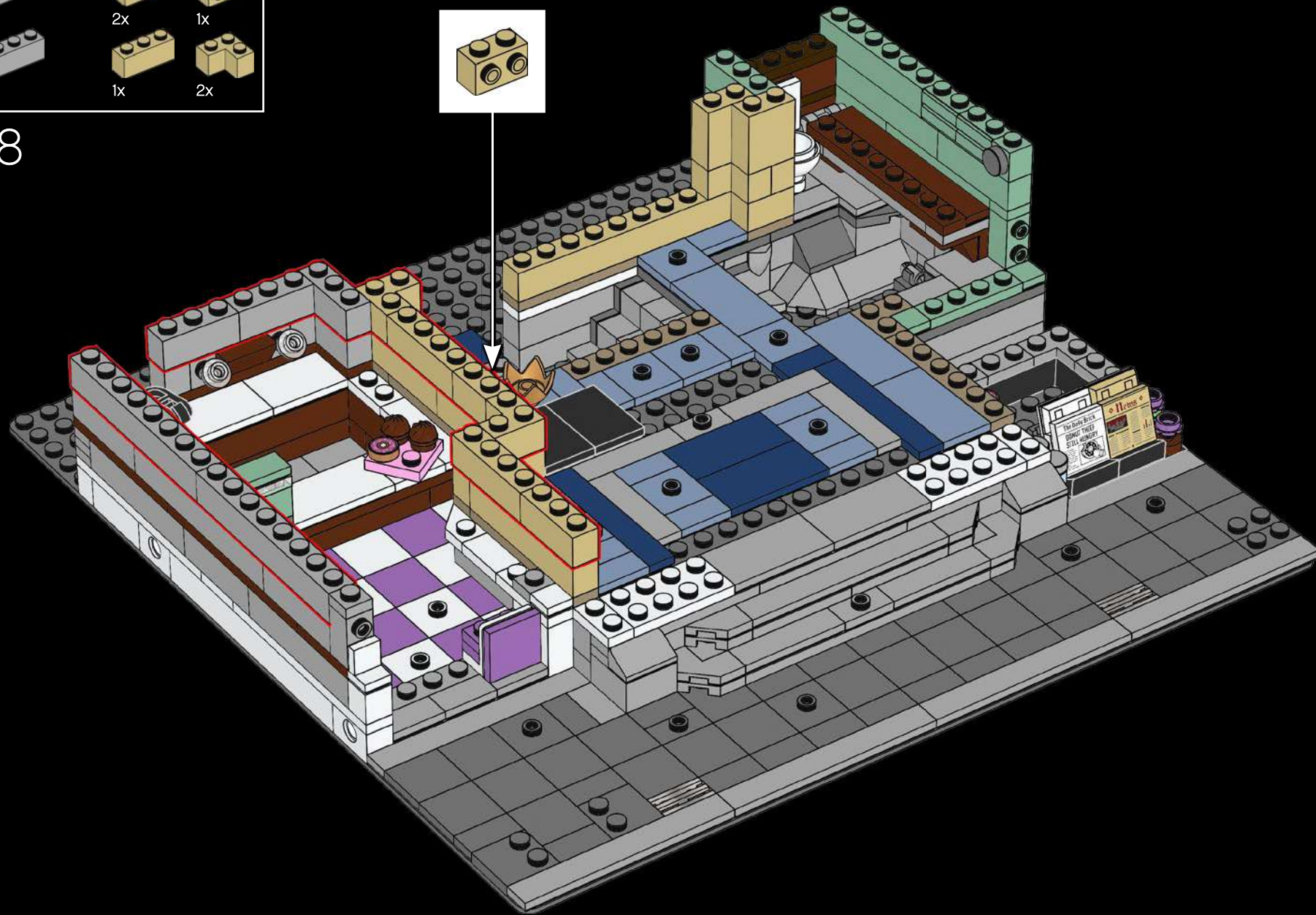

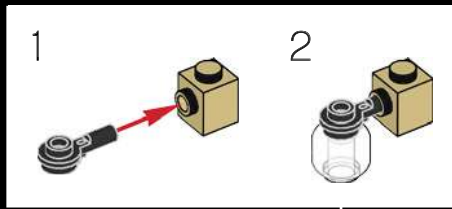
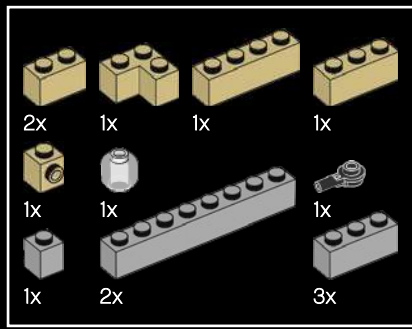

40

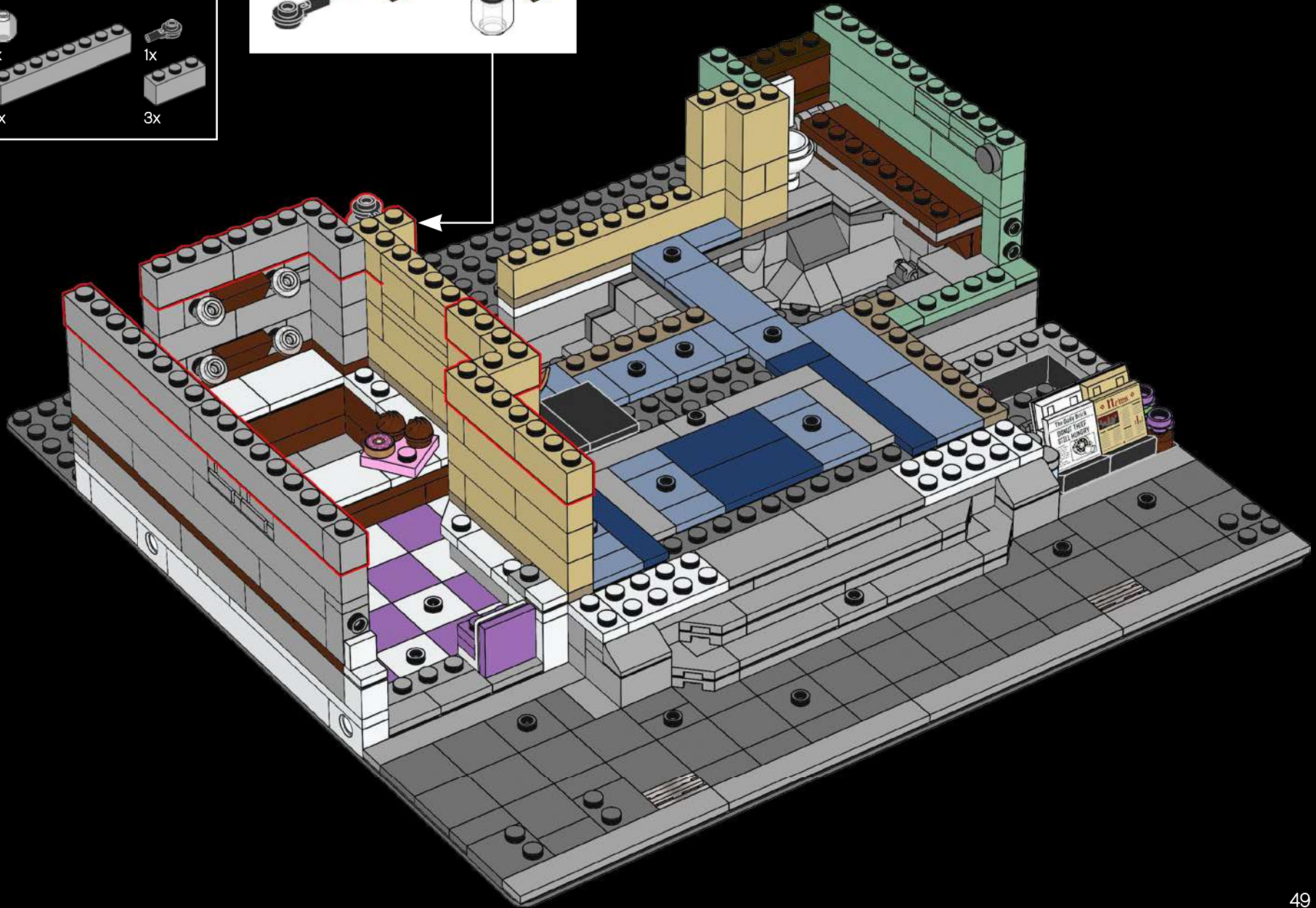

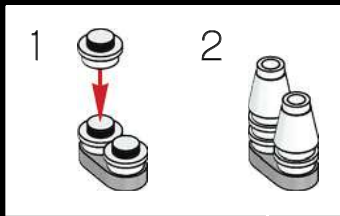
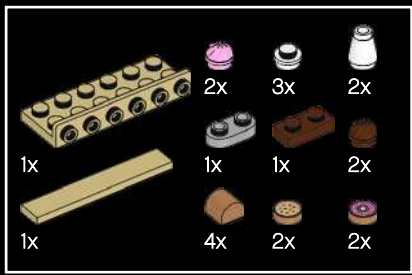

41

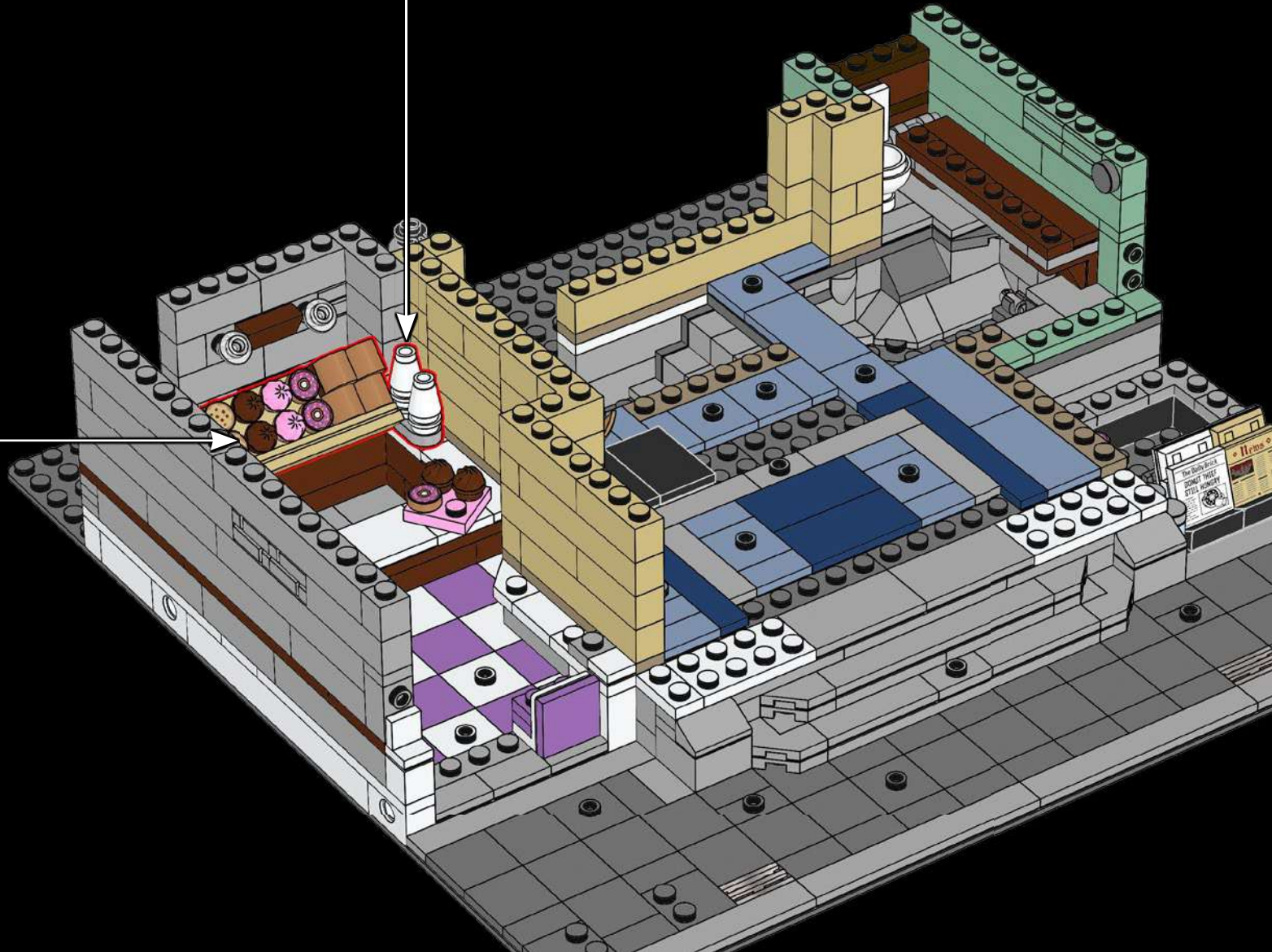
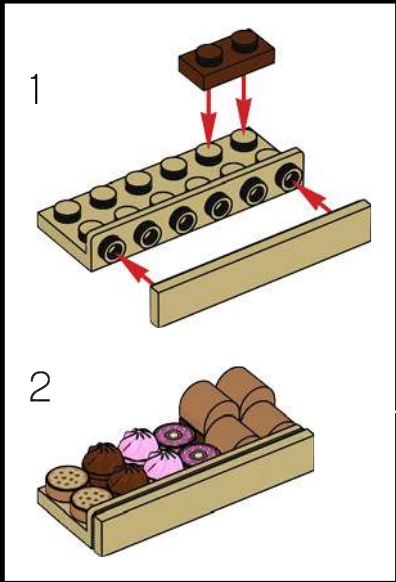

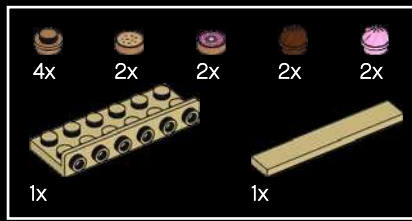

42

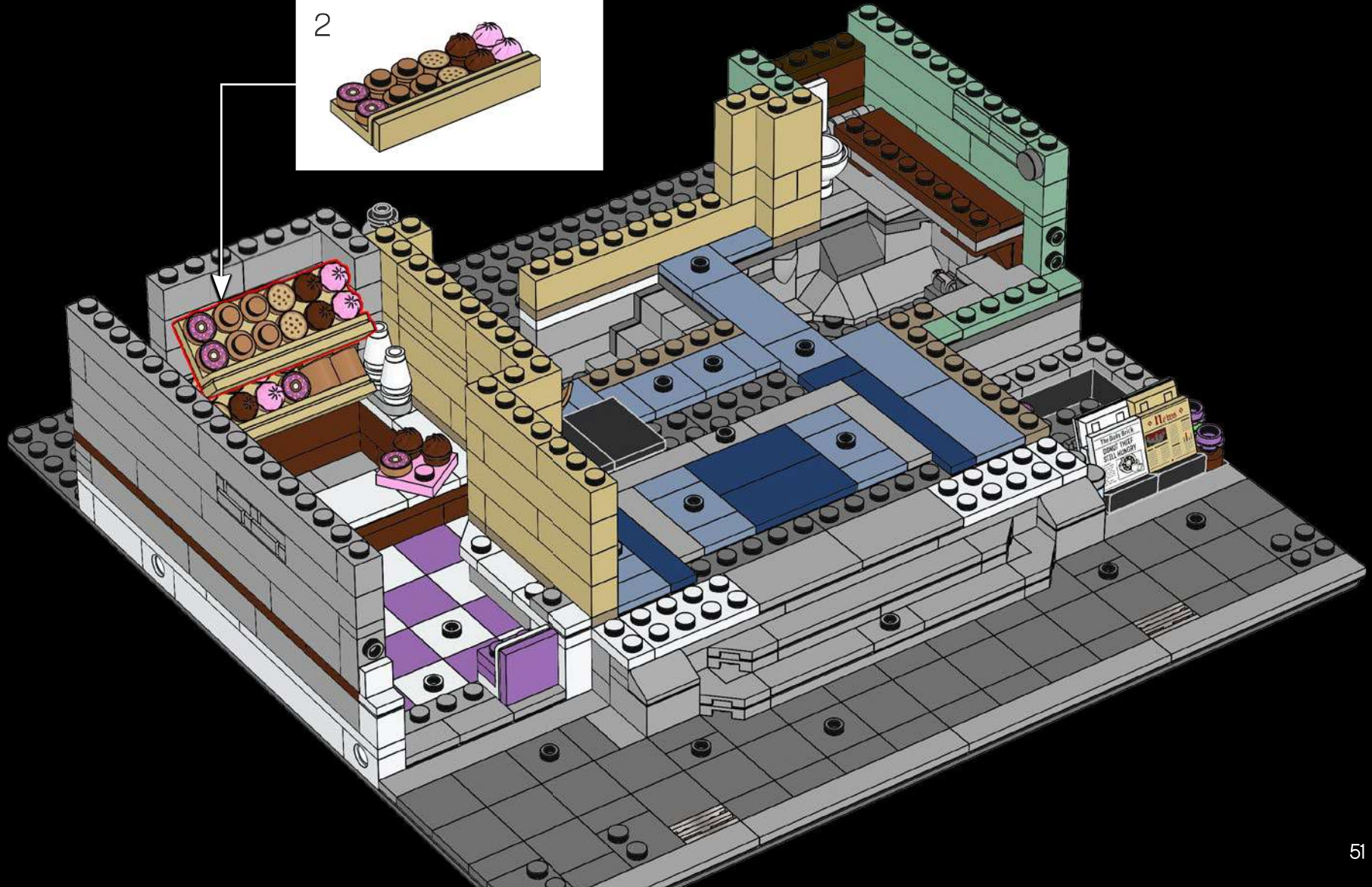
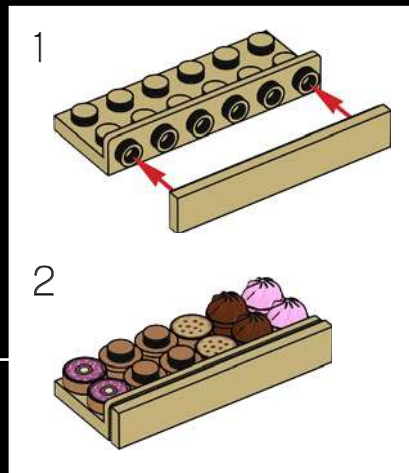

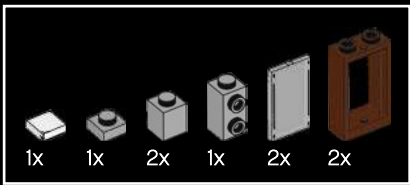

43

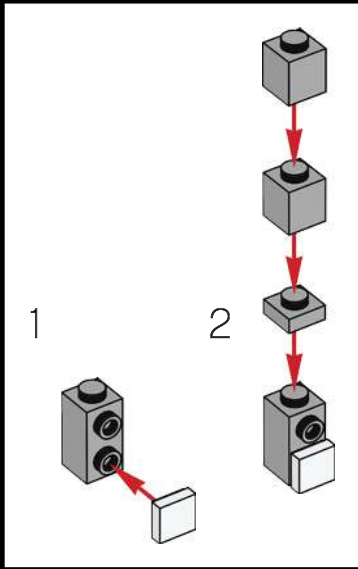
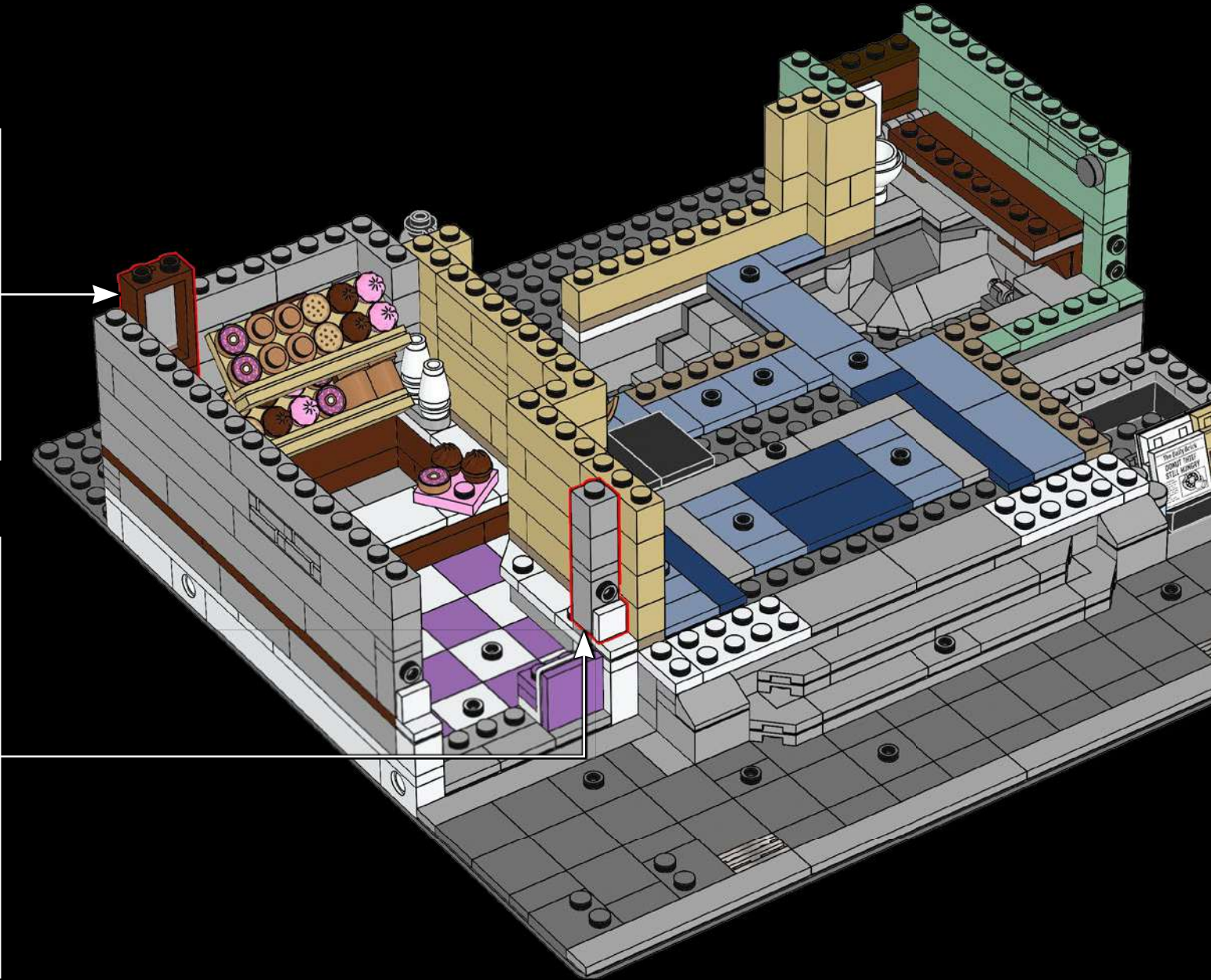
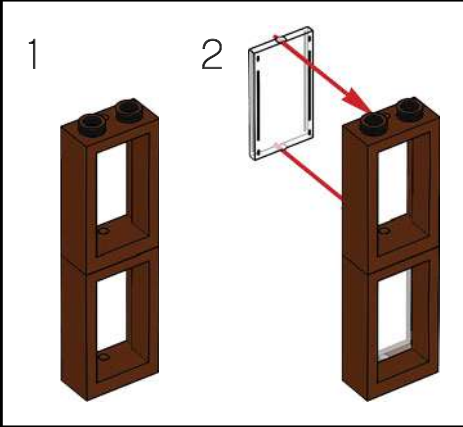

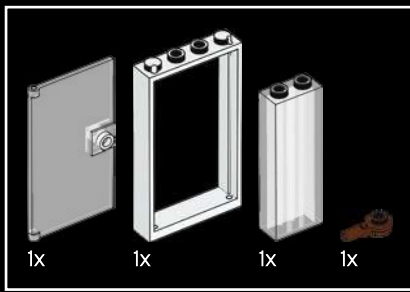

44

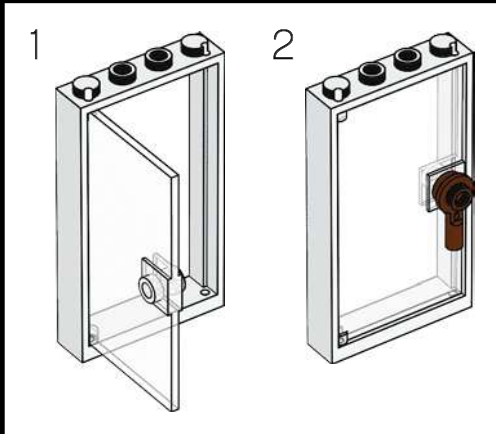
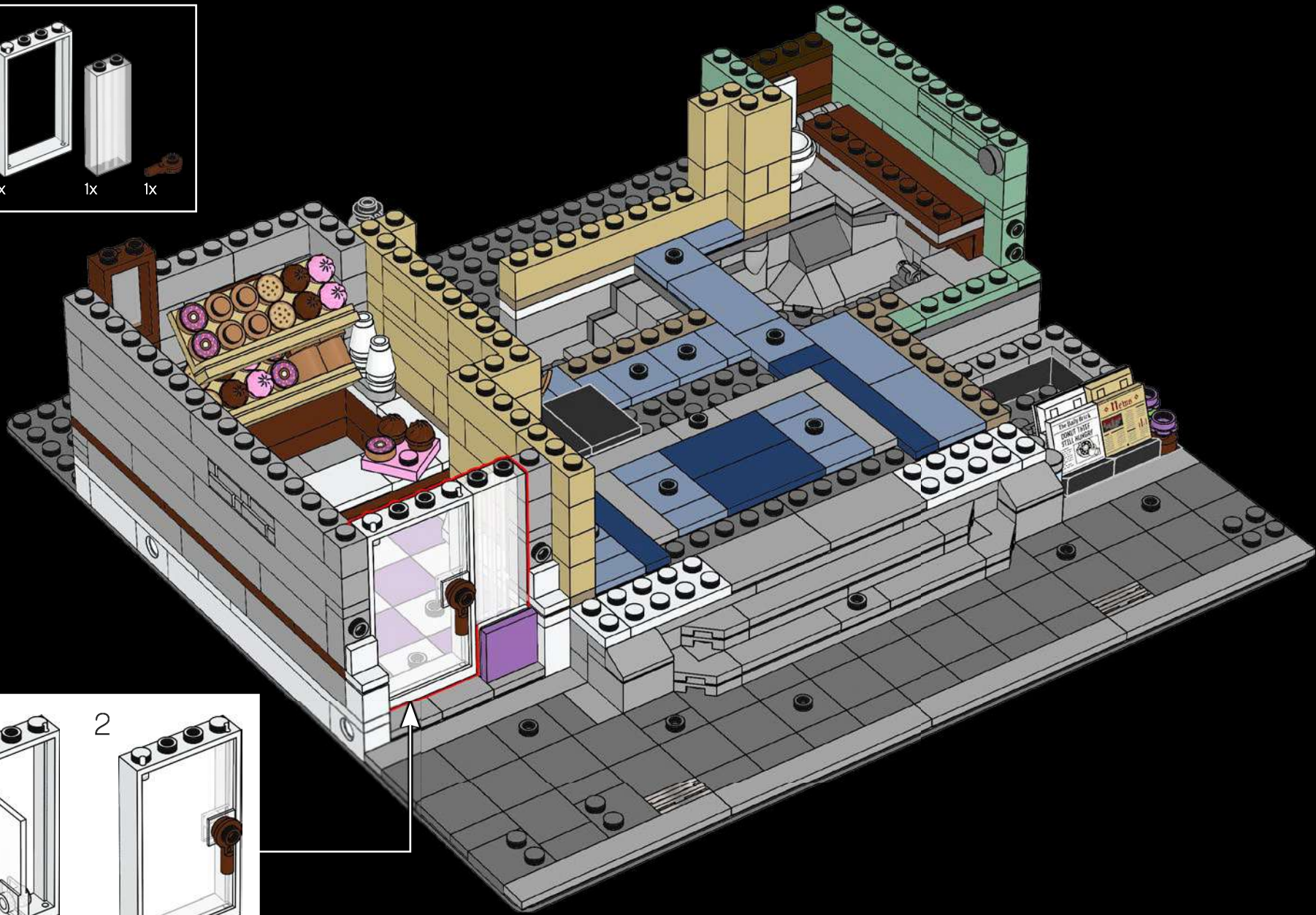

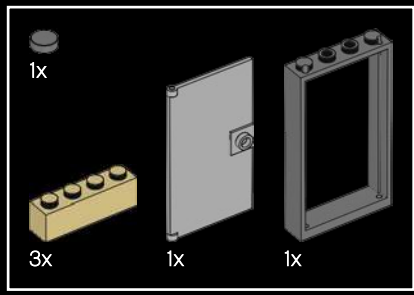

45

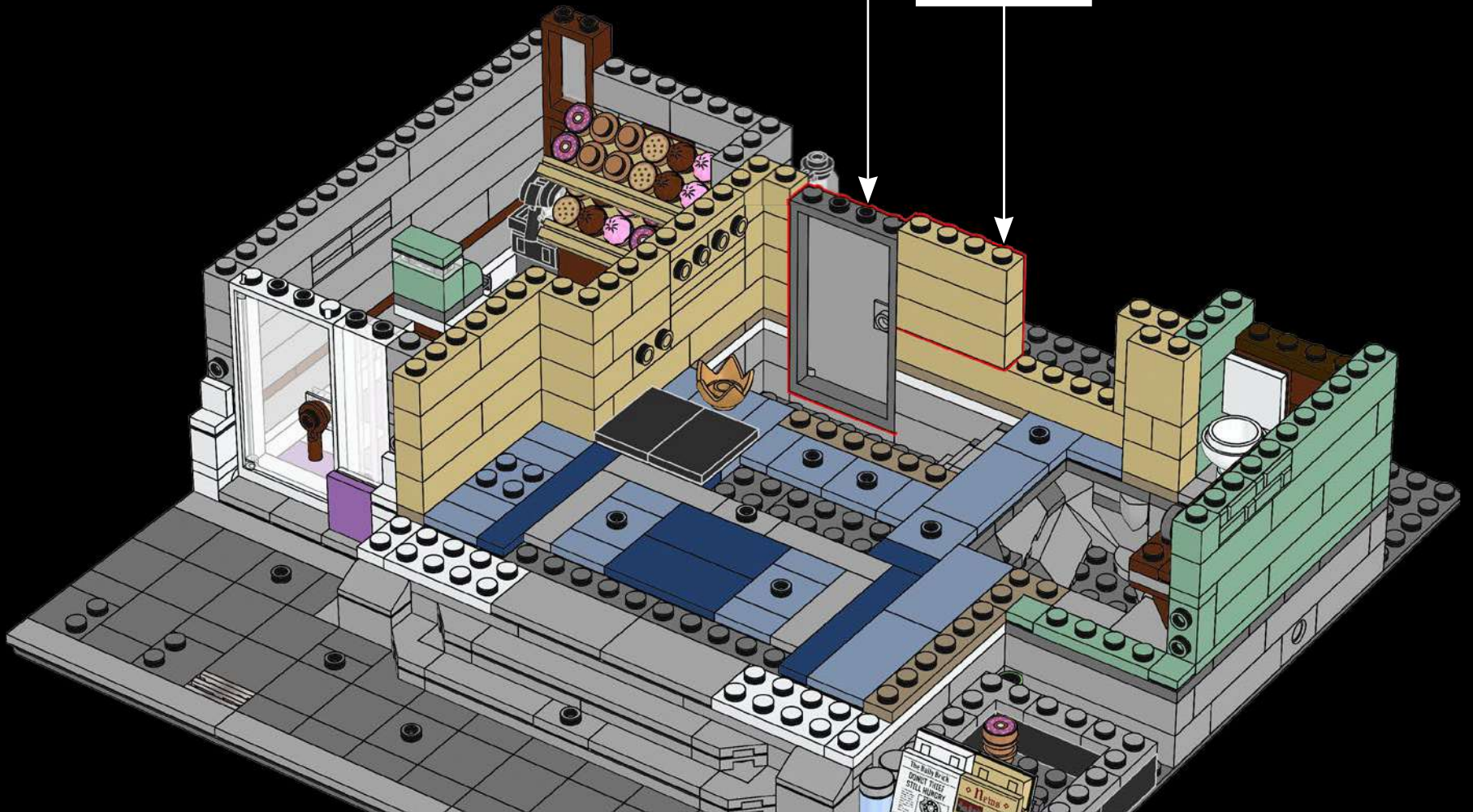
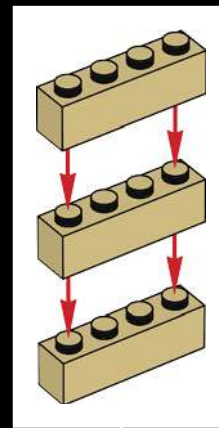
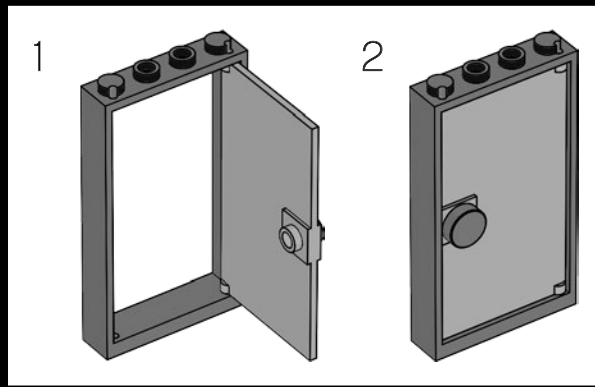

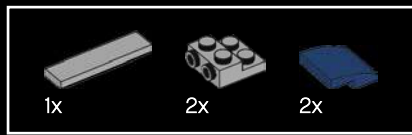

46

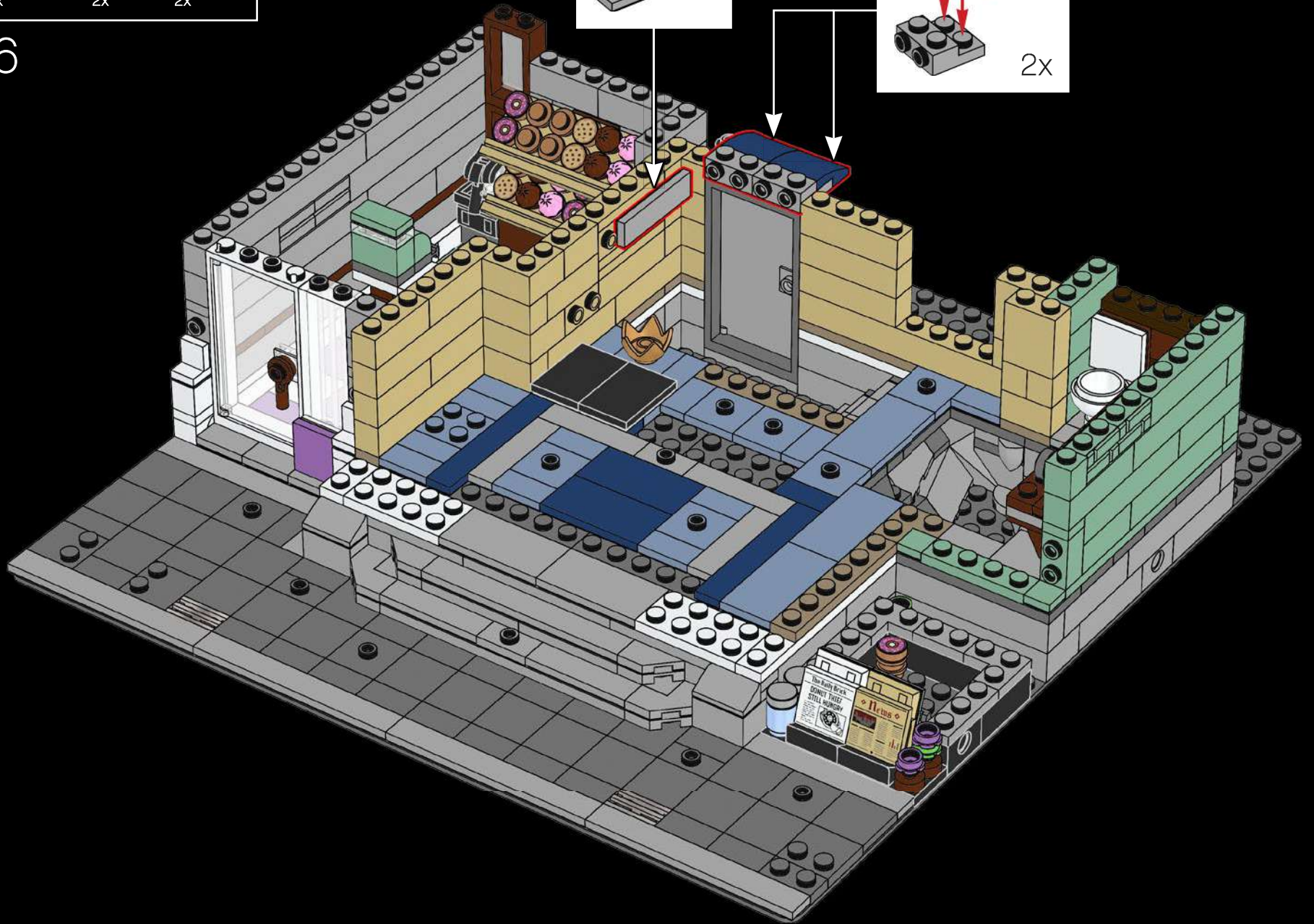
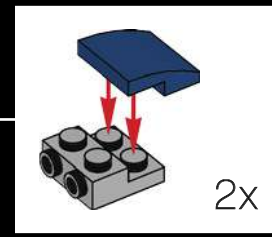
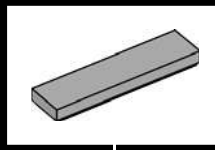



53



54

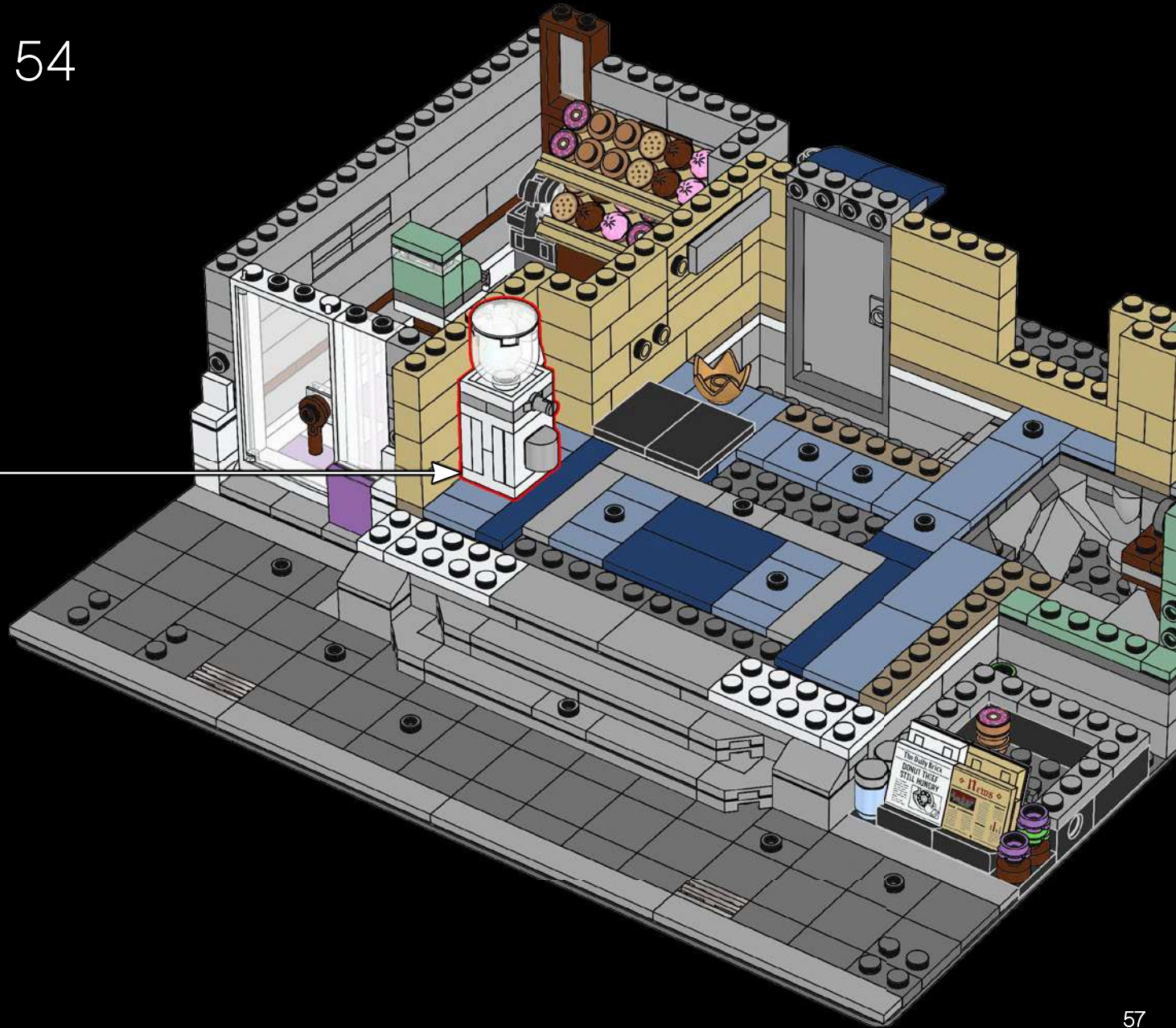

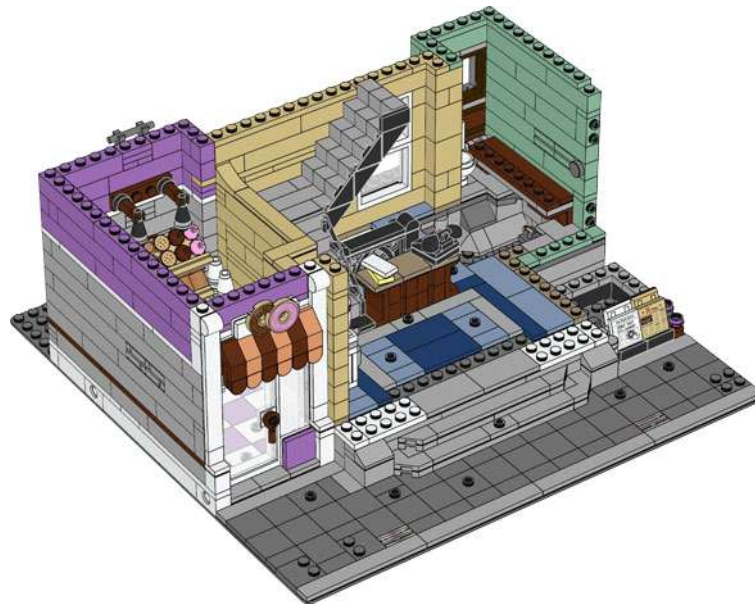

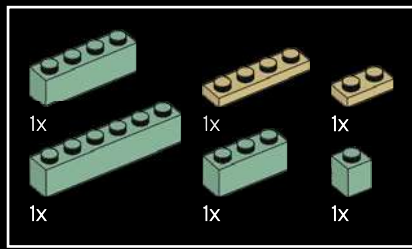

55



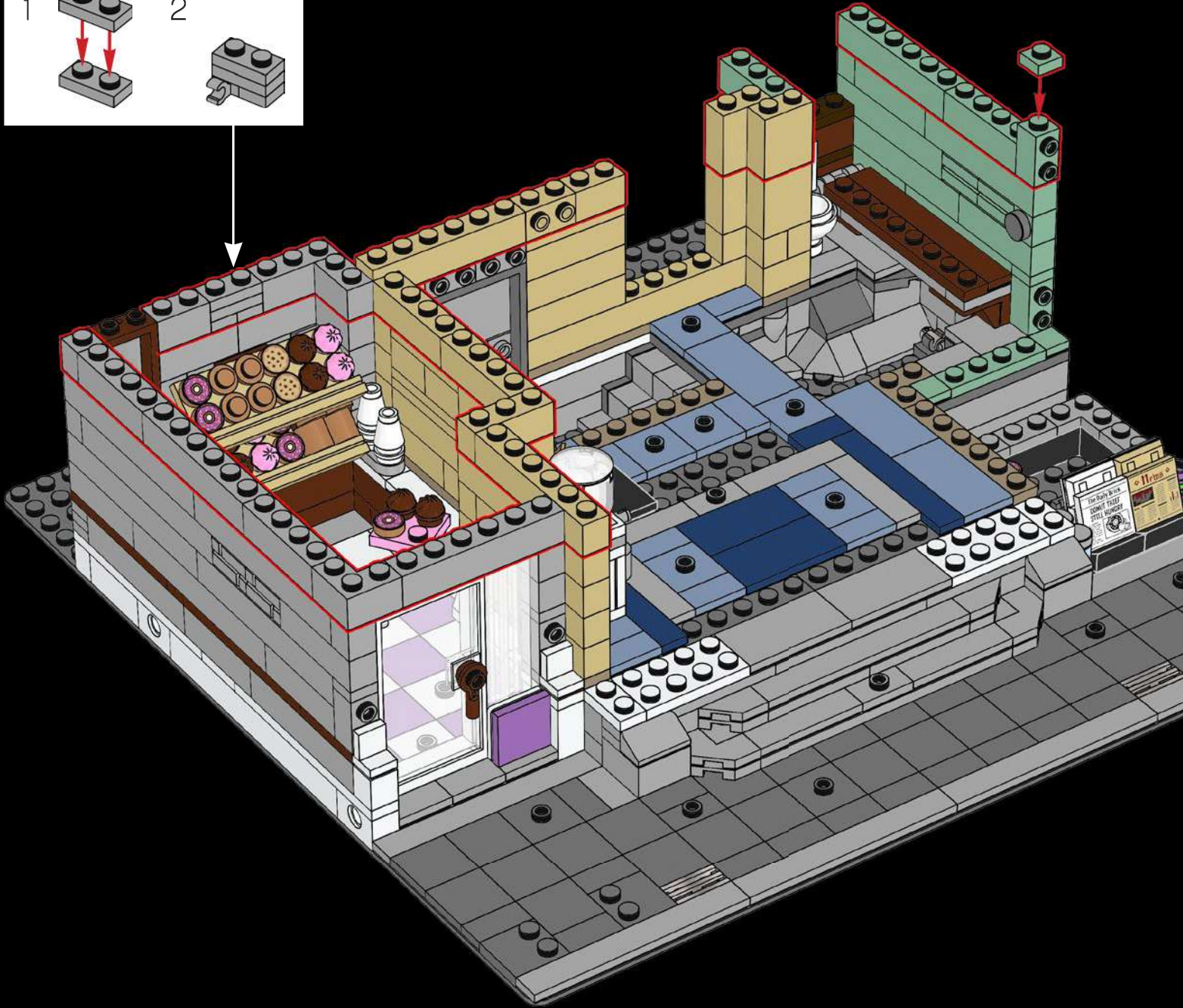
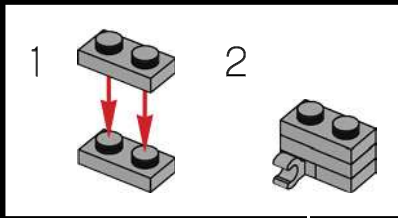
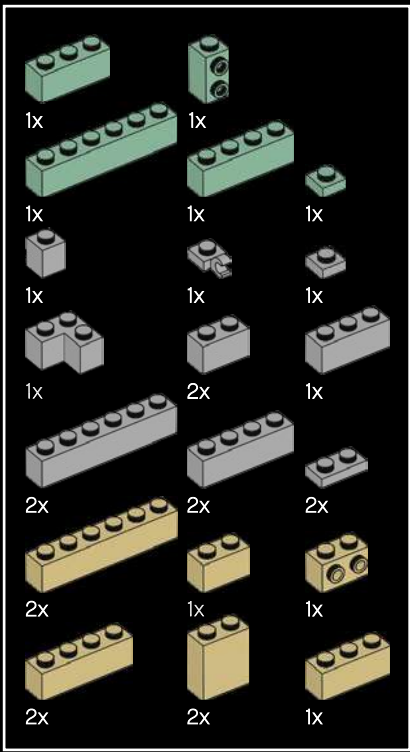

56

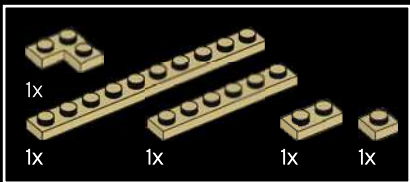

58

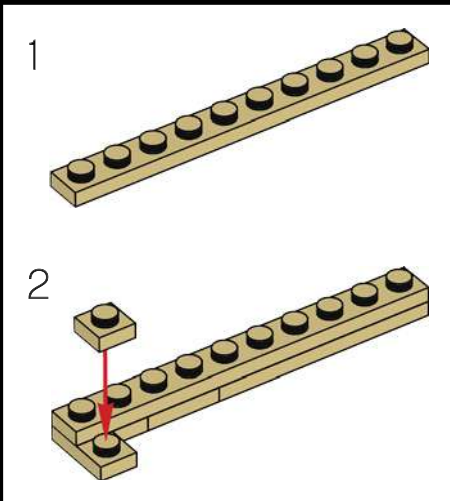

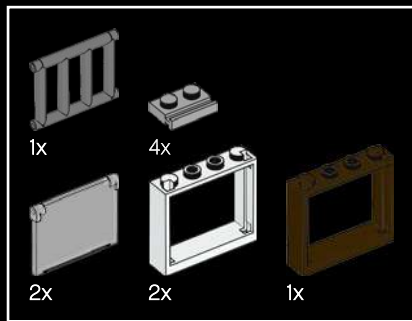

59

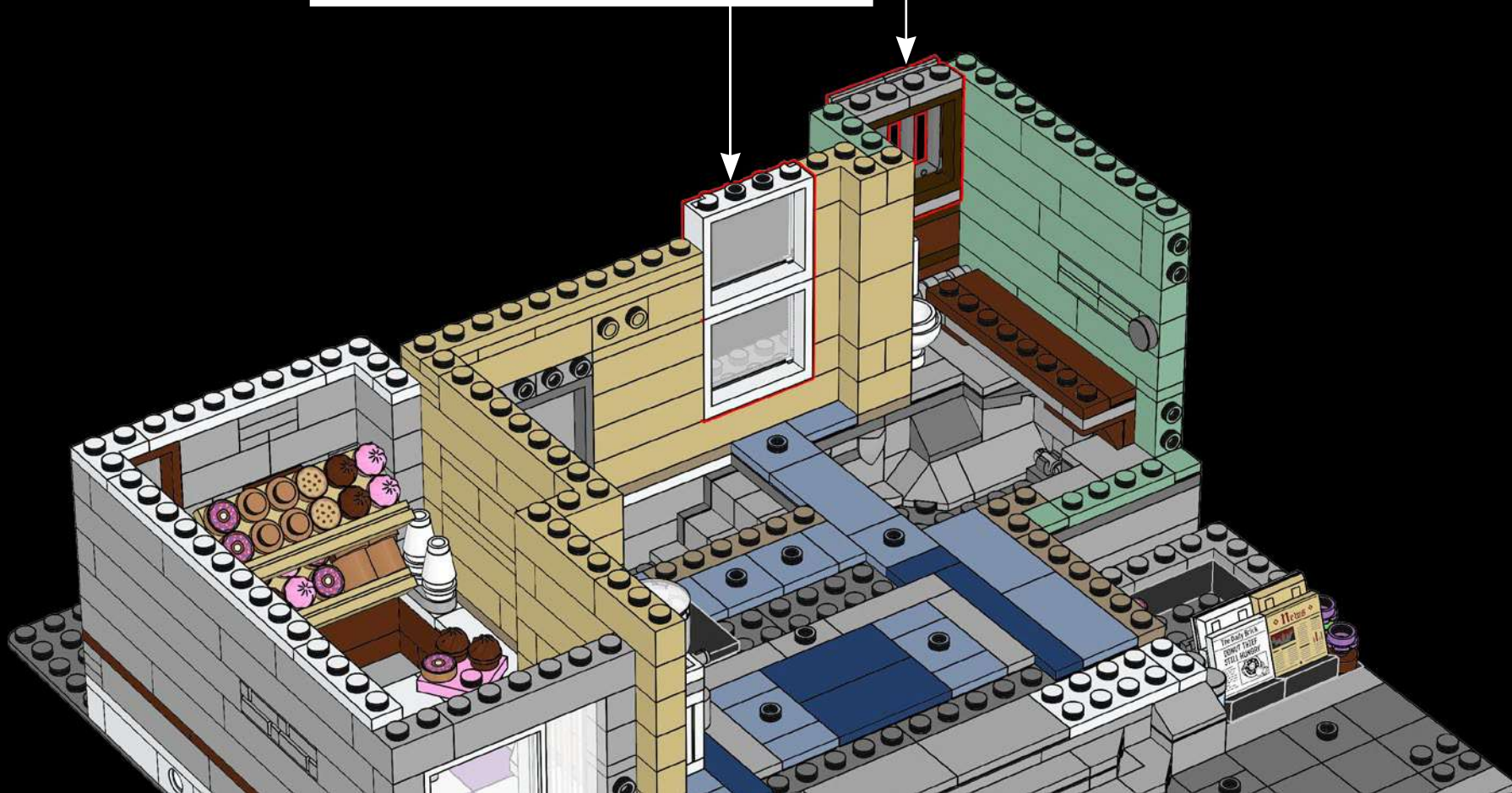
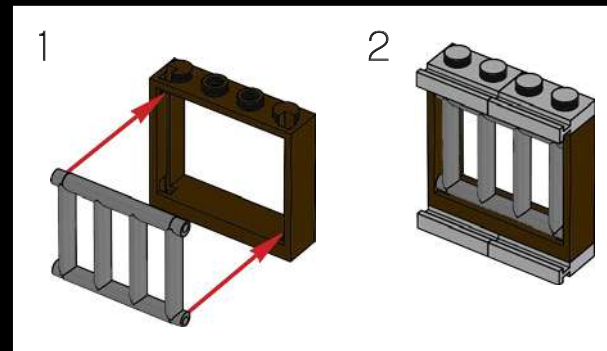
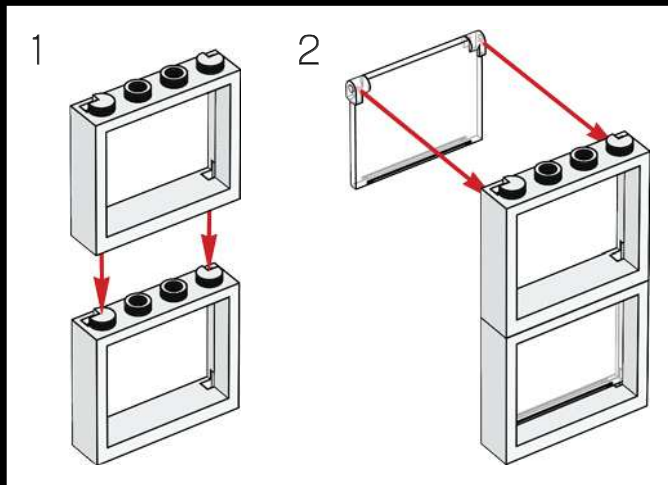

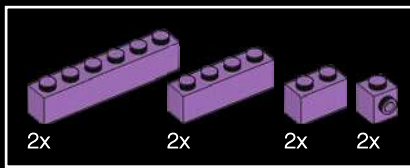

60

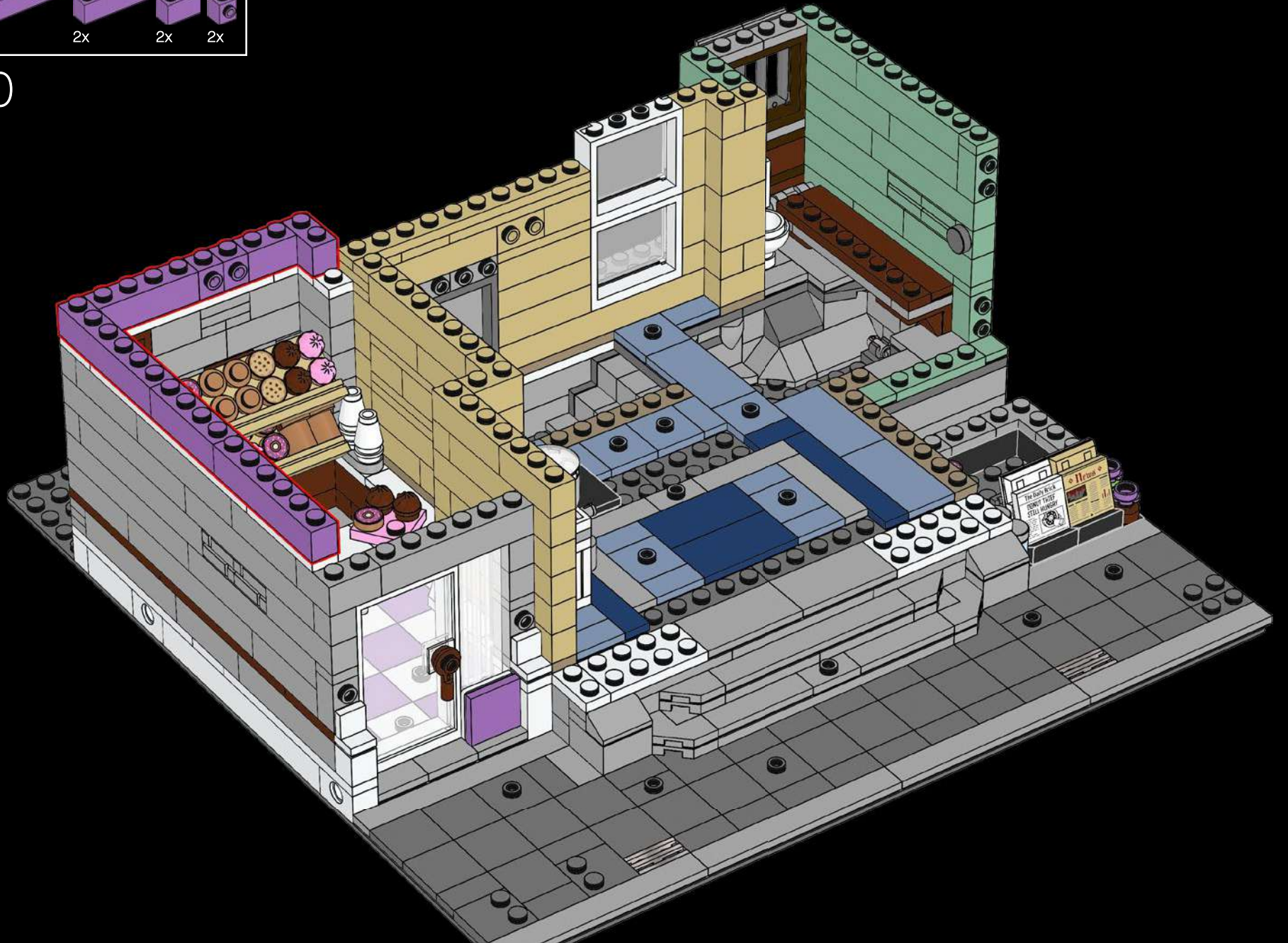

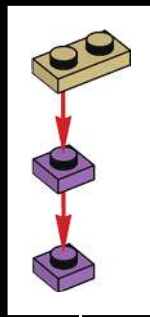
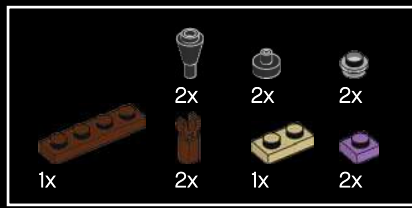

61

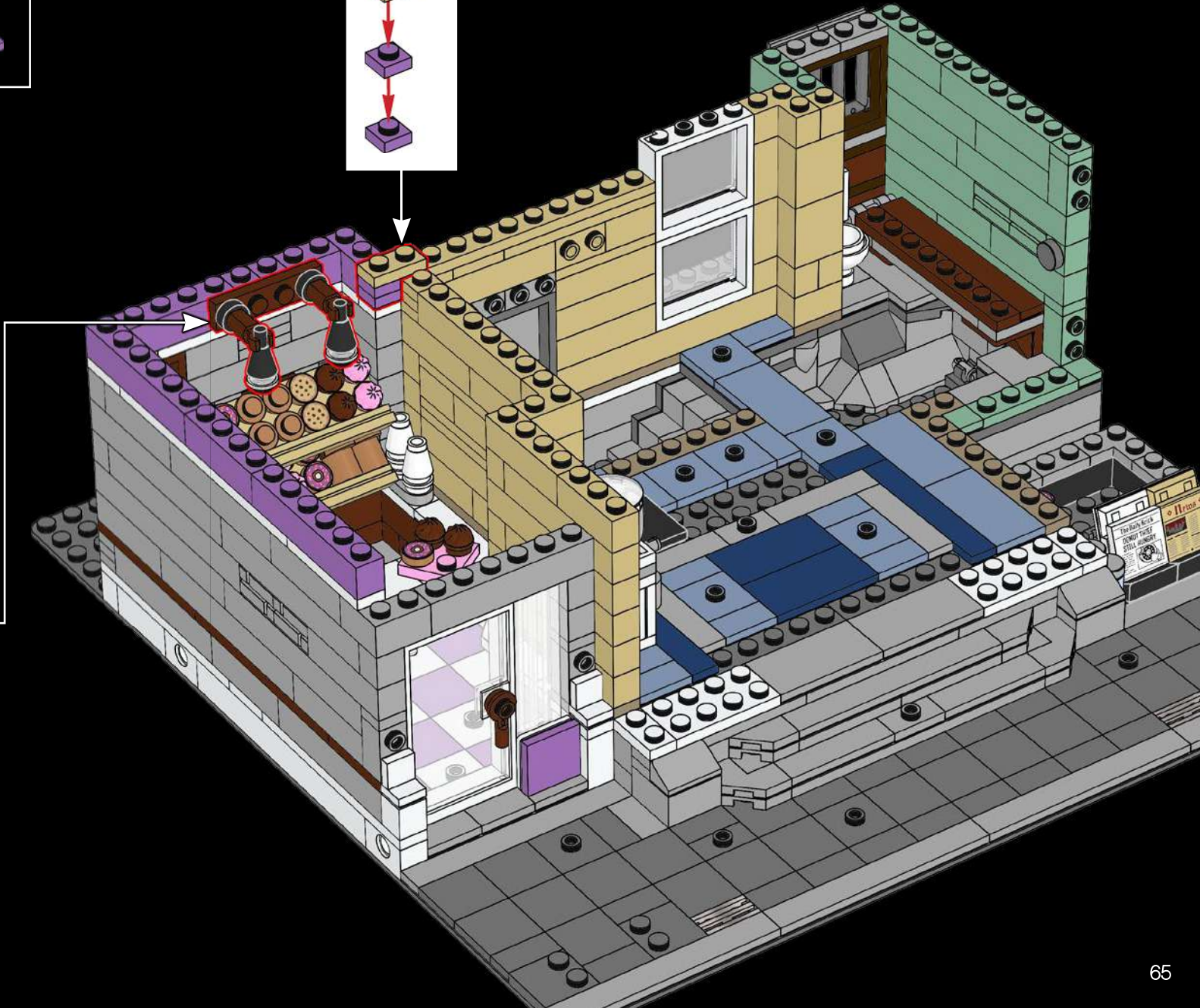
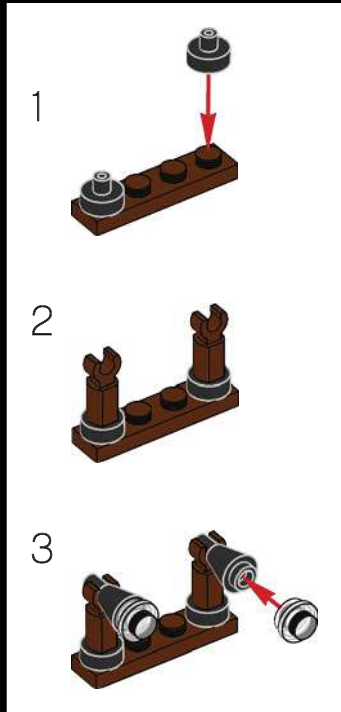

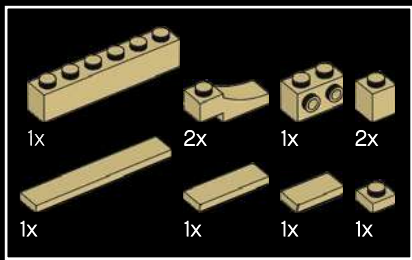

62

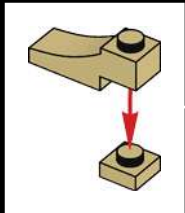
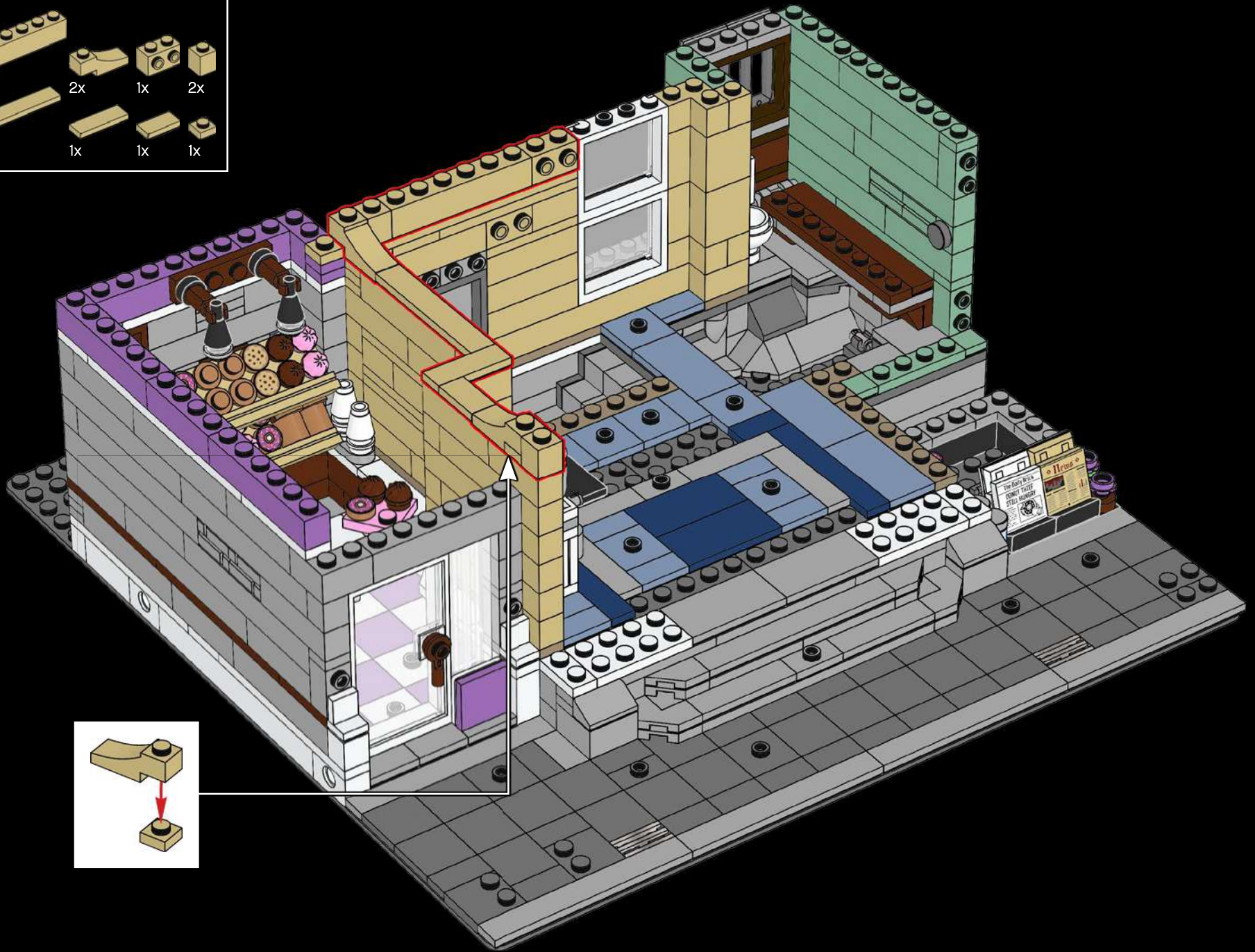



68

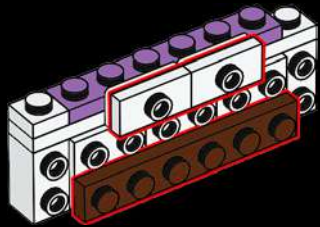

69

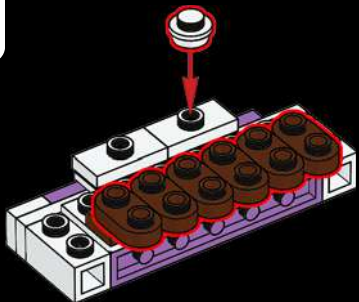

70

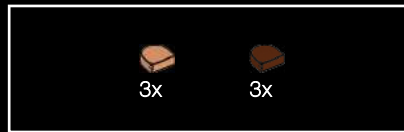
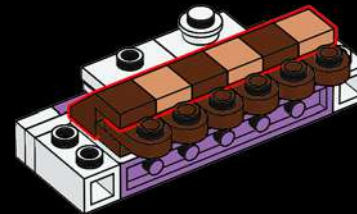

71

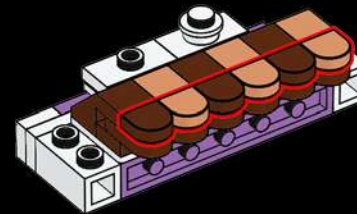

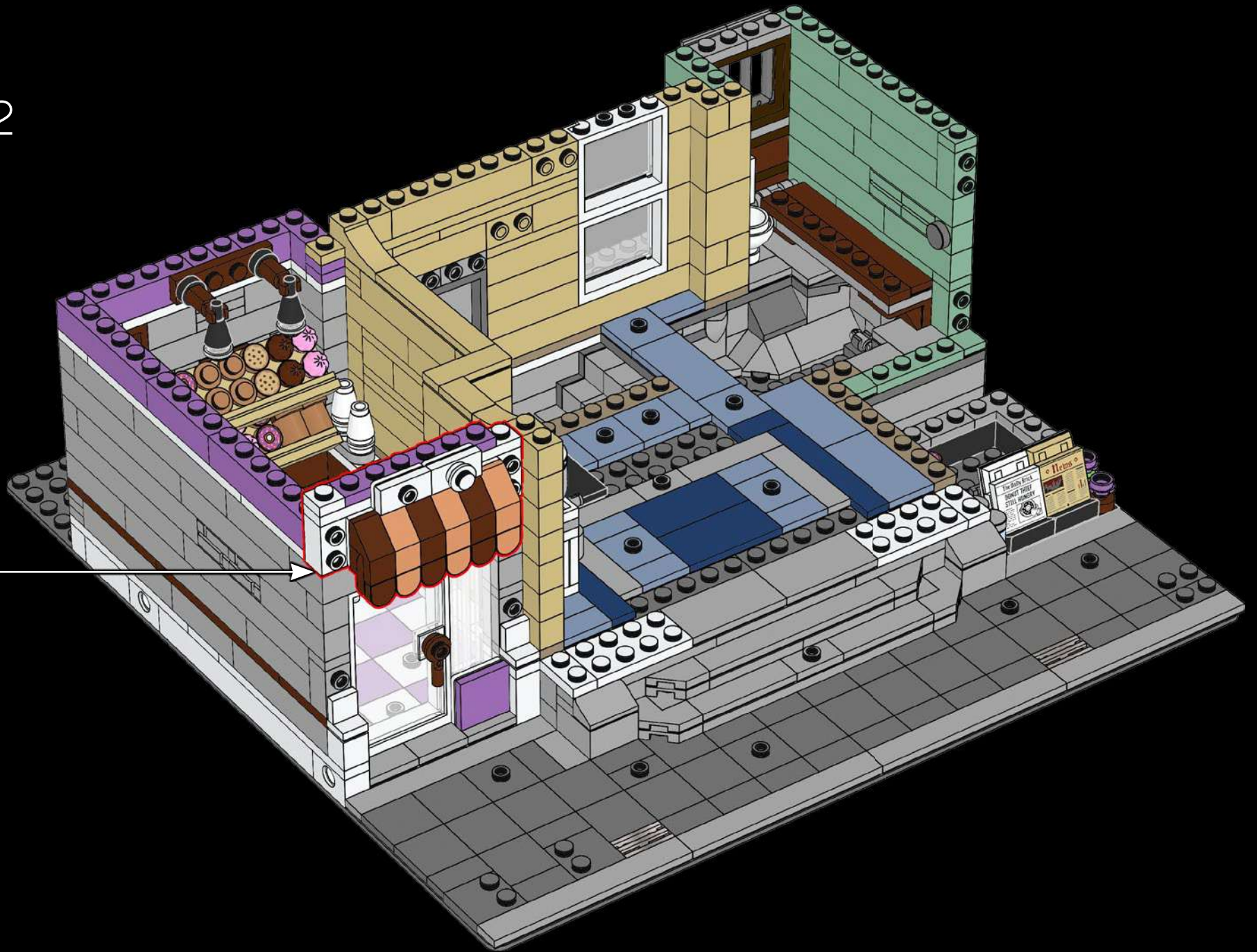

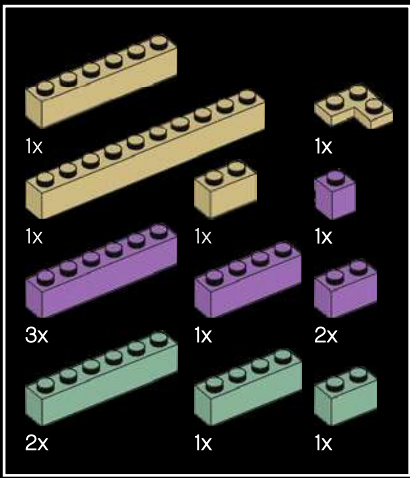

73

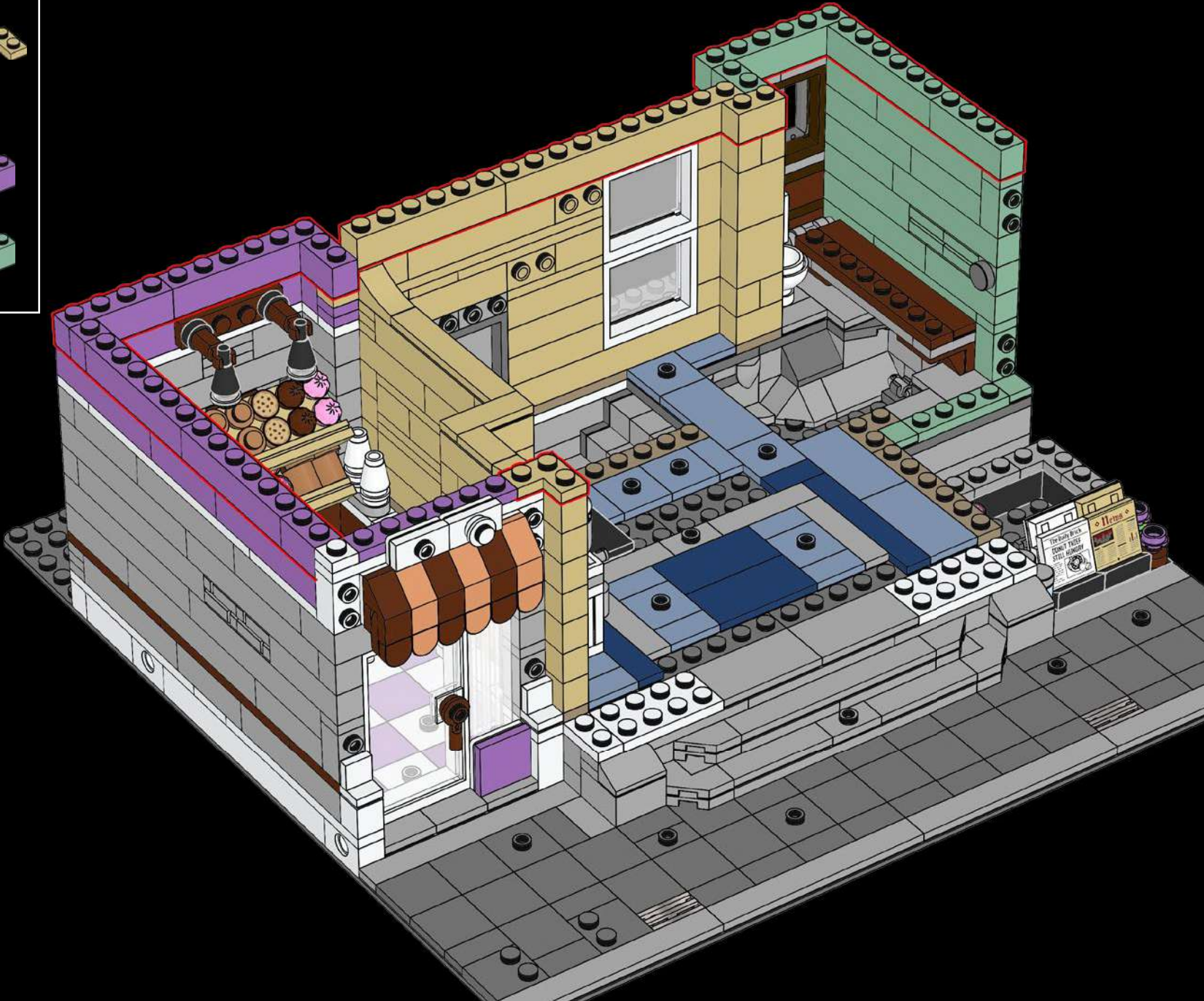

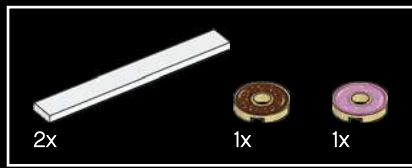

74



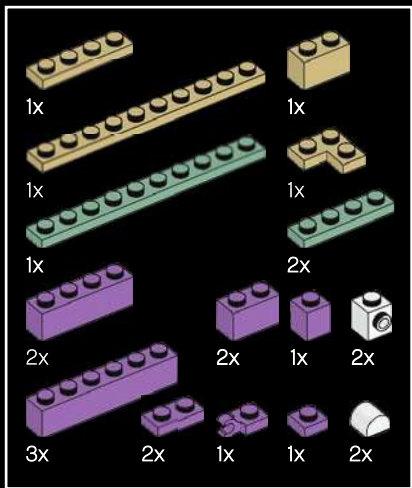

75

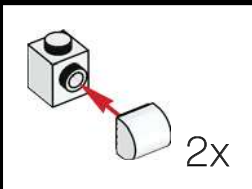
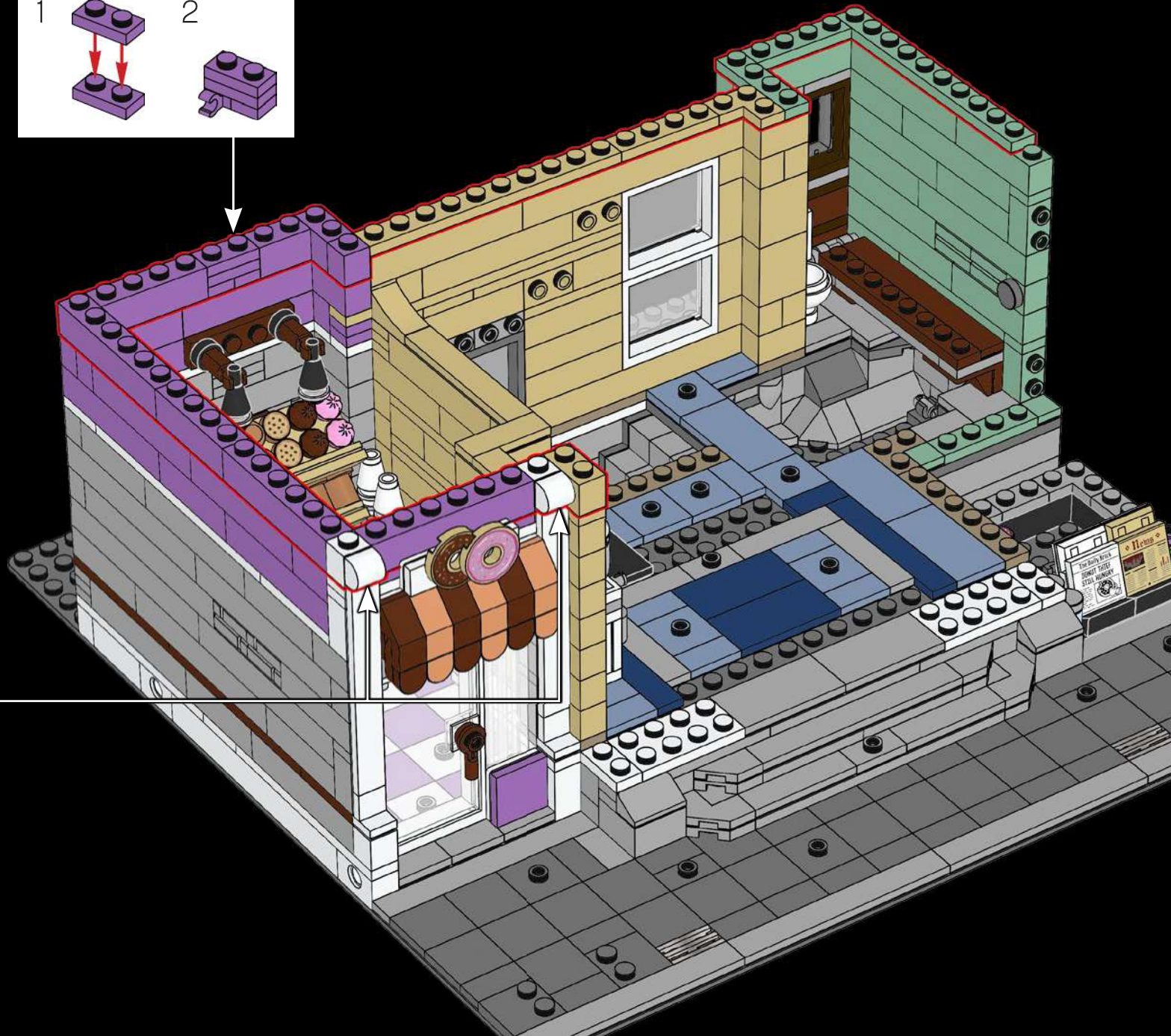
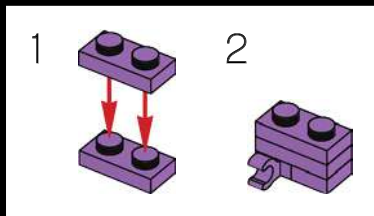

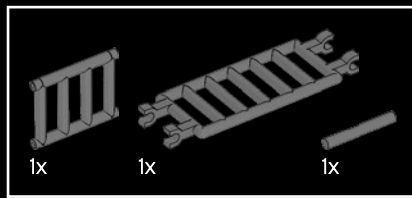

76

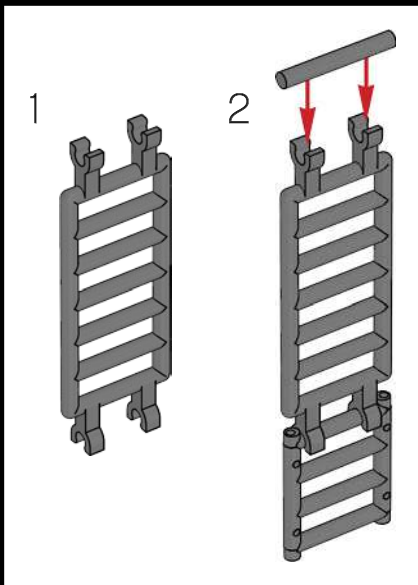

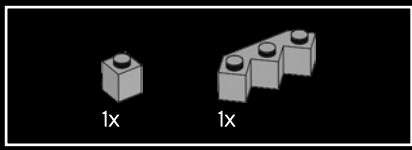

77

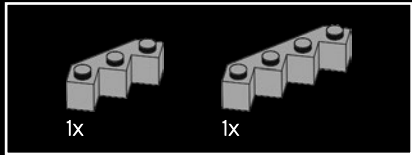
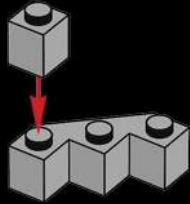

78

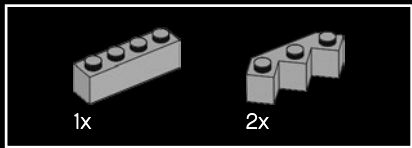
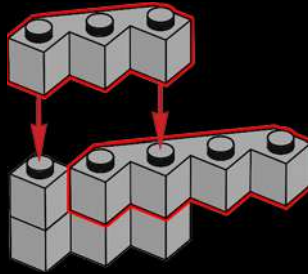

79

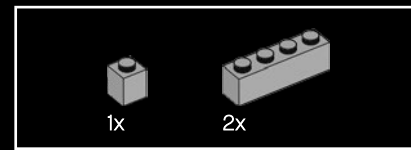
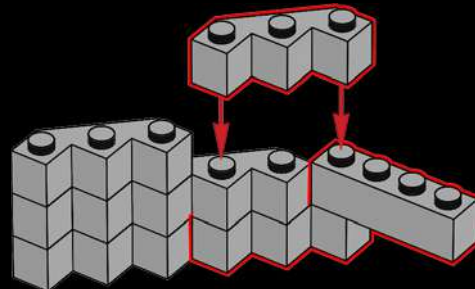

80

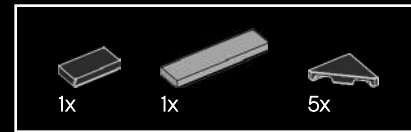
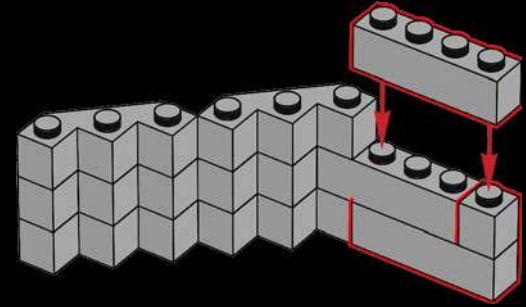

81

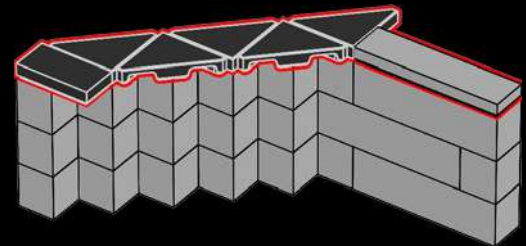



The station's grand staircase is constructed with facet bricks that have been flipped on their sides.

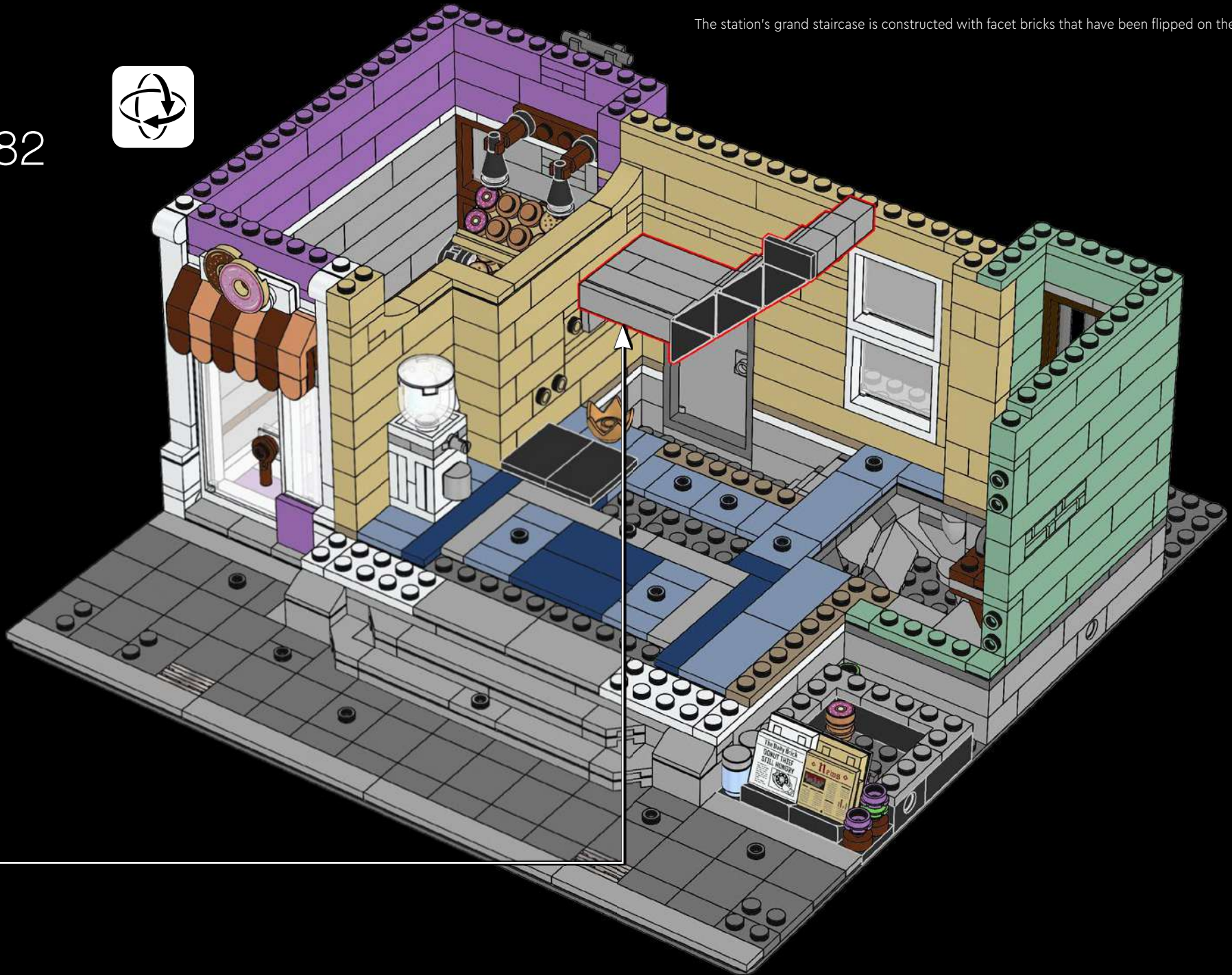

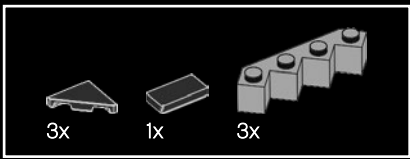

83

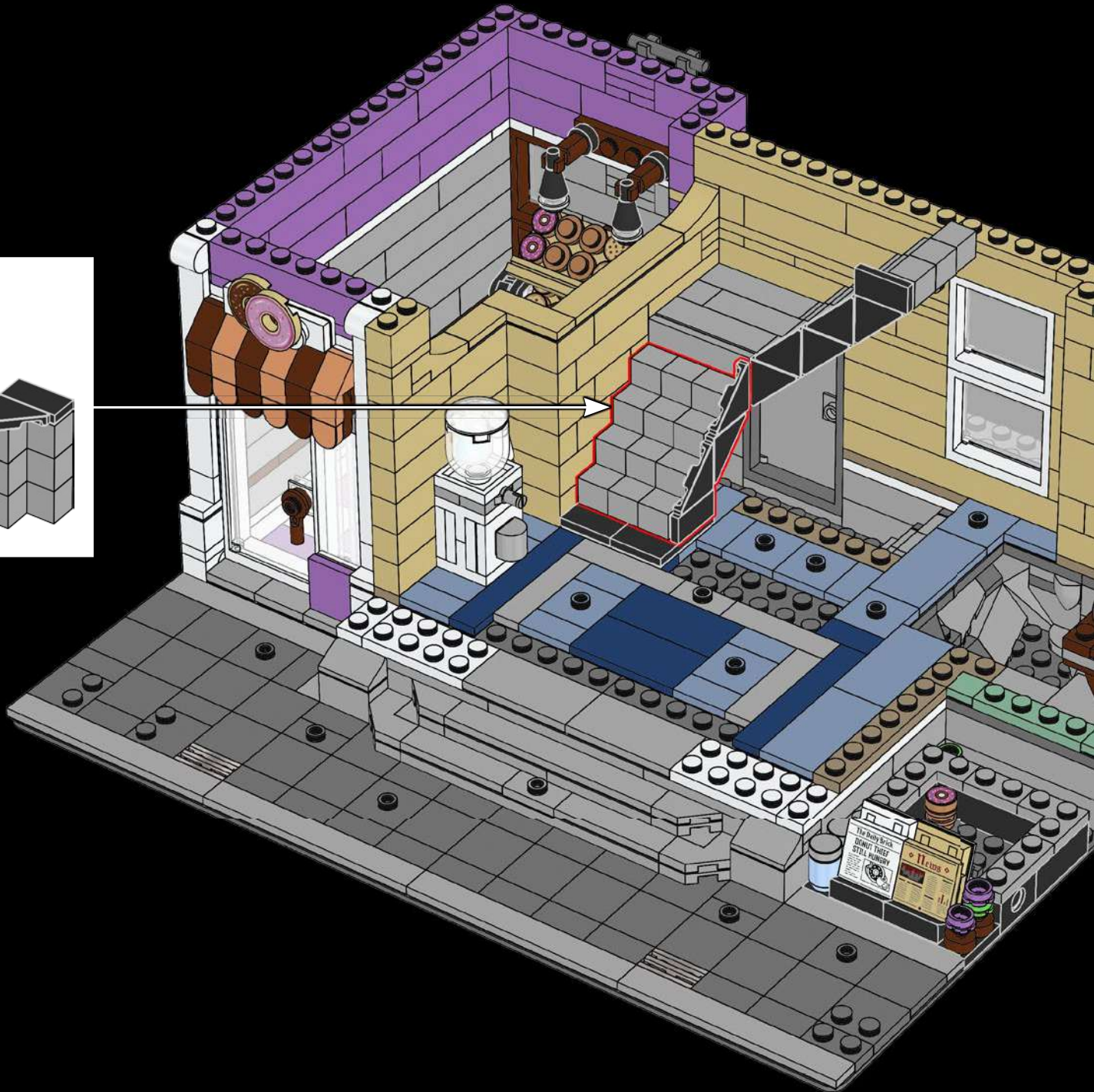
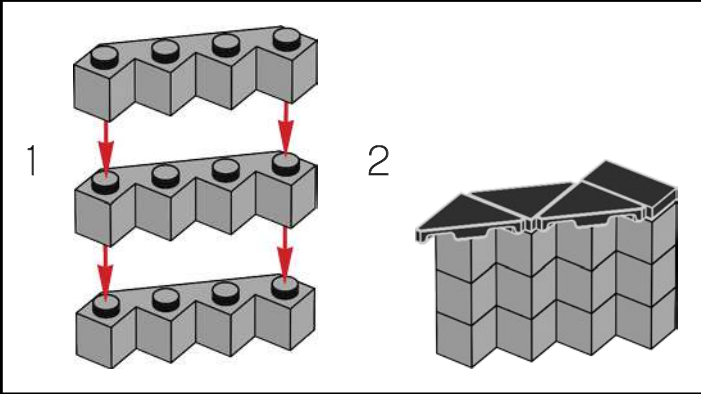

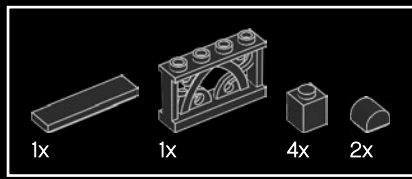

84

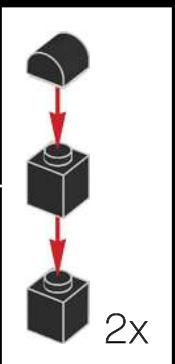
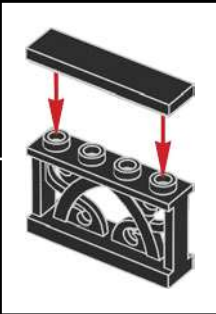
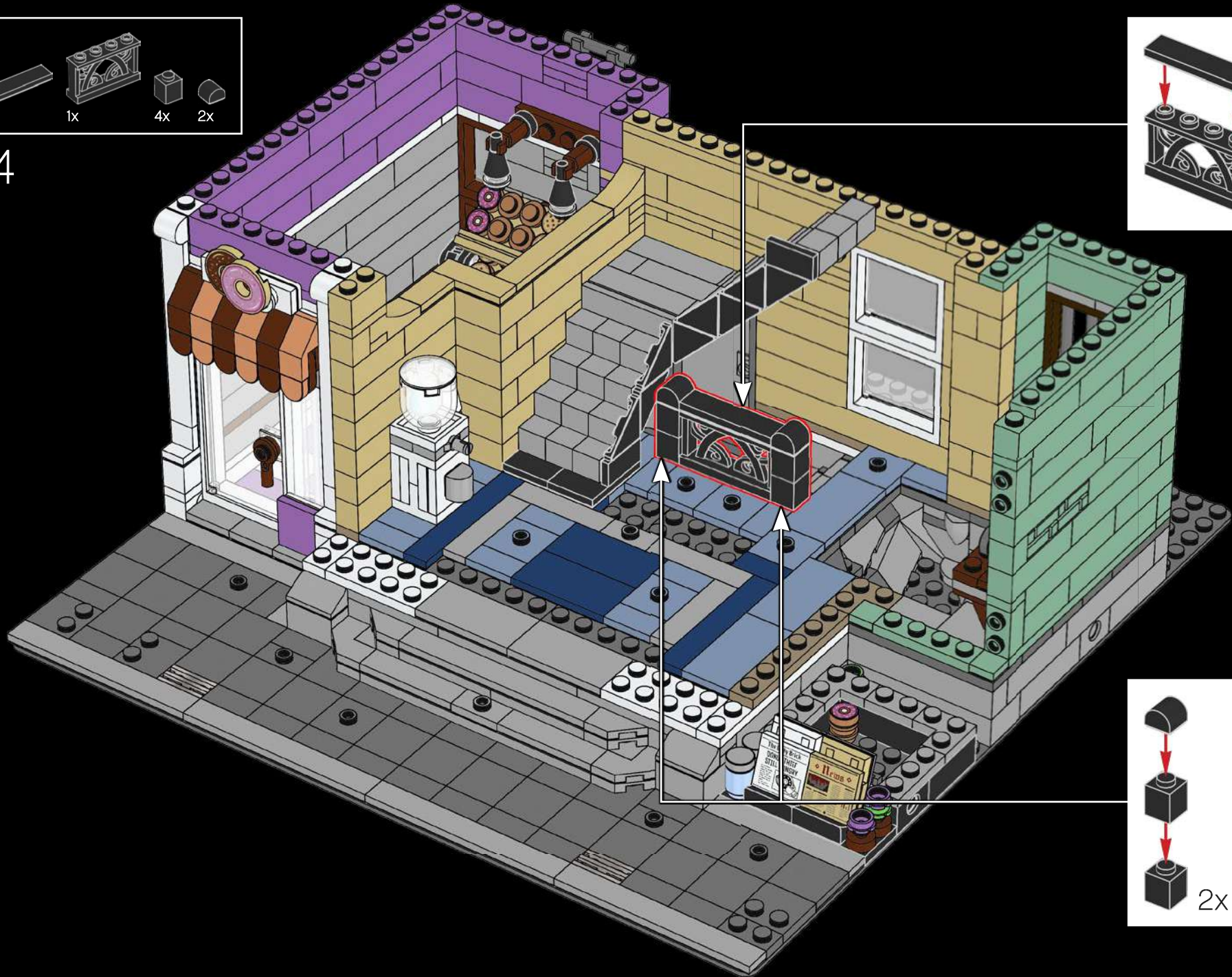

Whether it's movies, television, or LEGO® sets, rotary telephones really communicate the time period of the story.

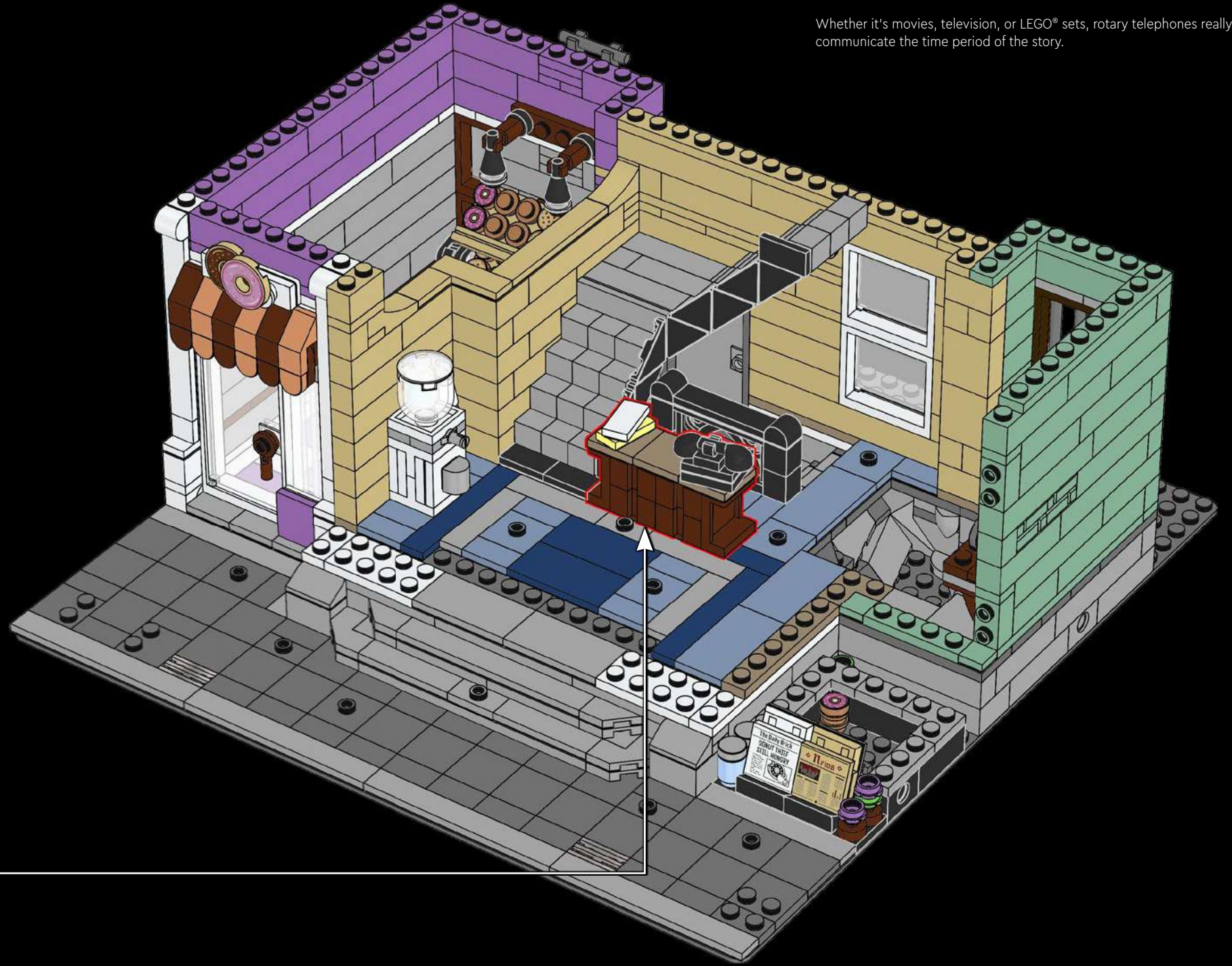

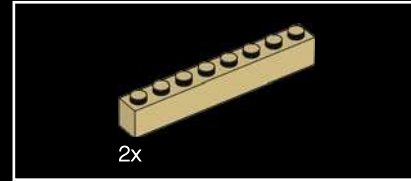
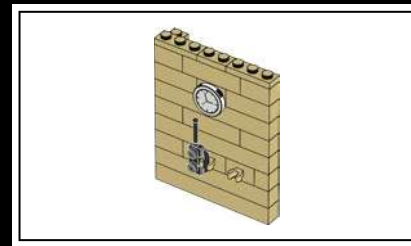
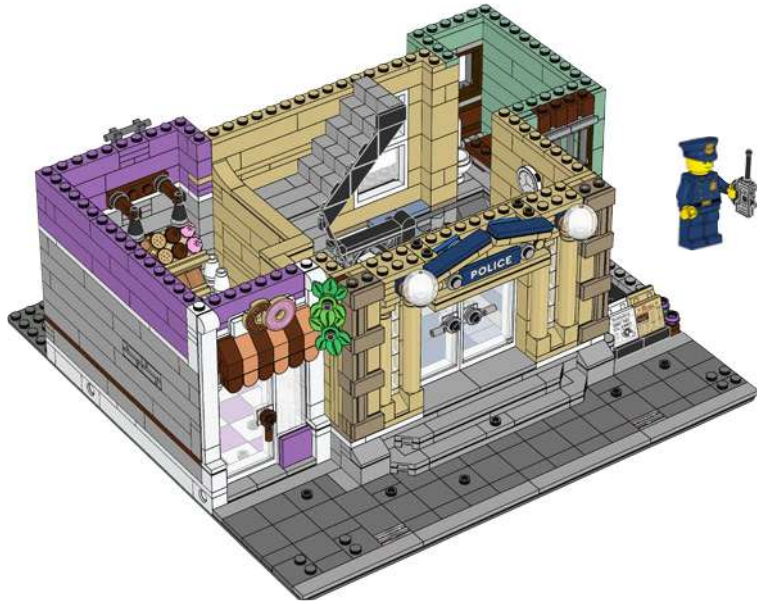
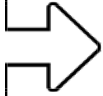

2x

86

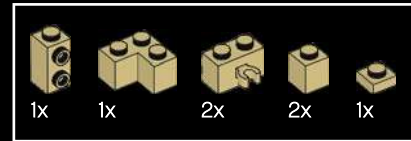
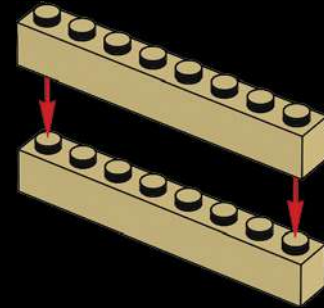

87

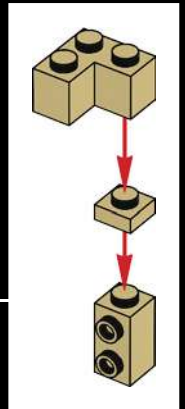
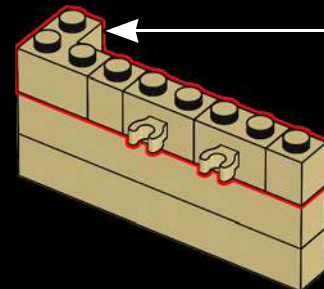

The fresh-faced constable is a recent graduate from the academy.

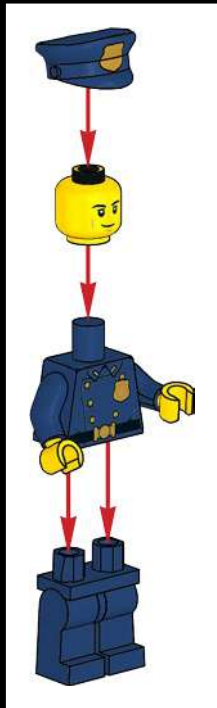

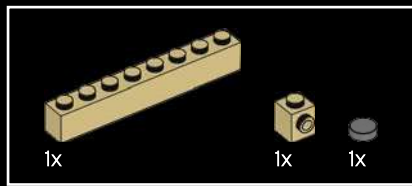

88

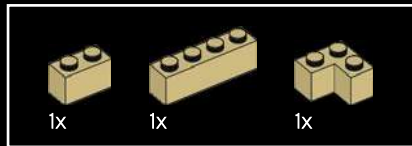
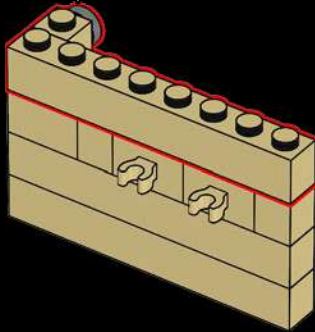
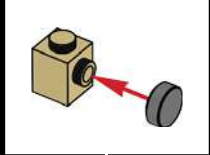

89

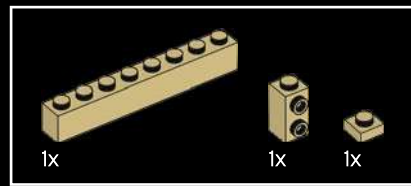
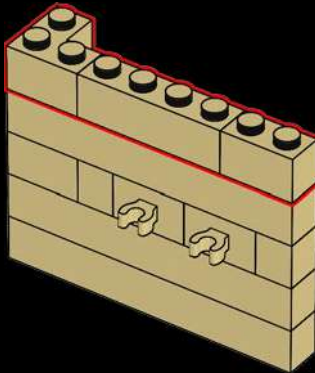

90

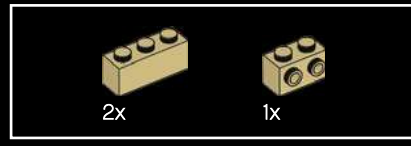
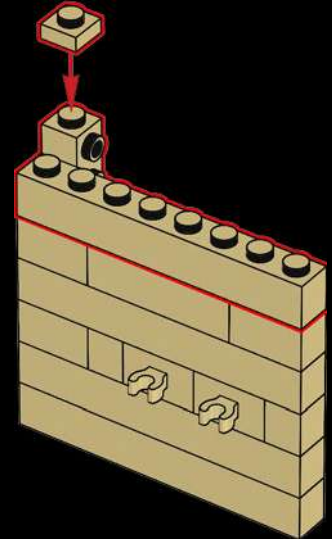

91

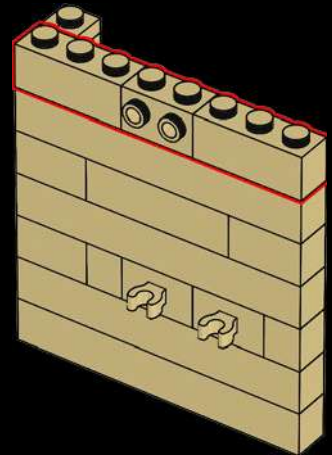

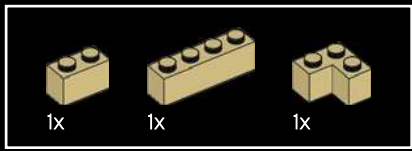

92

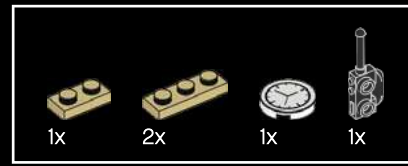
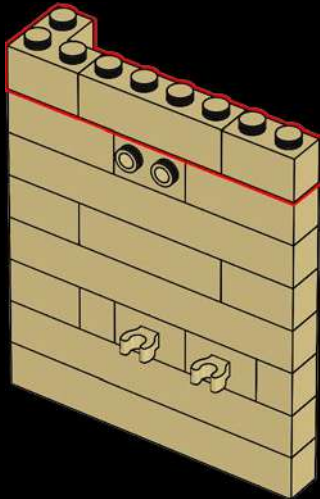

93

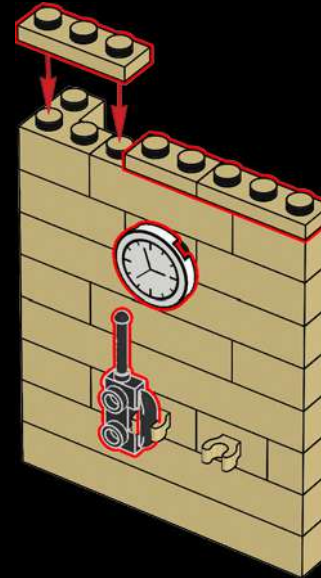

94



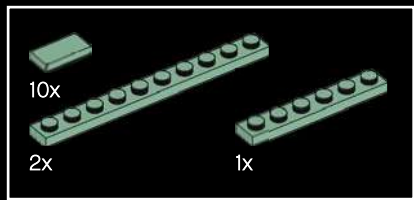

95

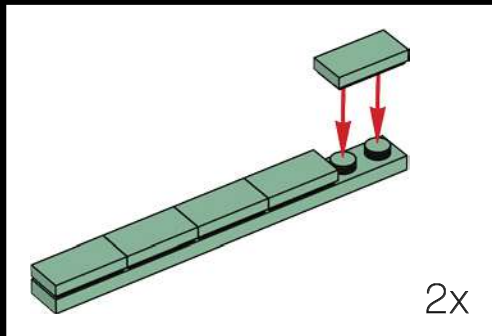
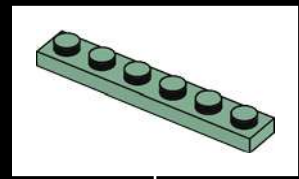
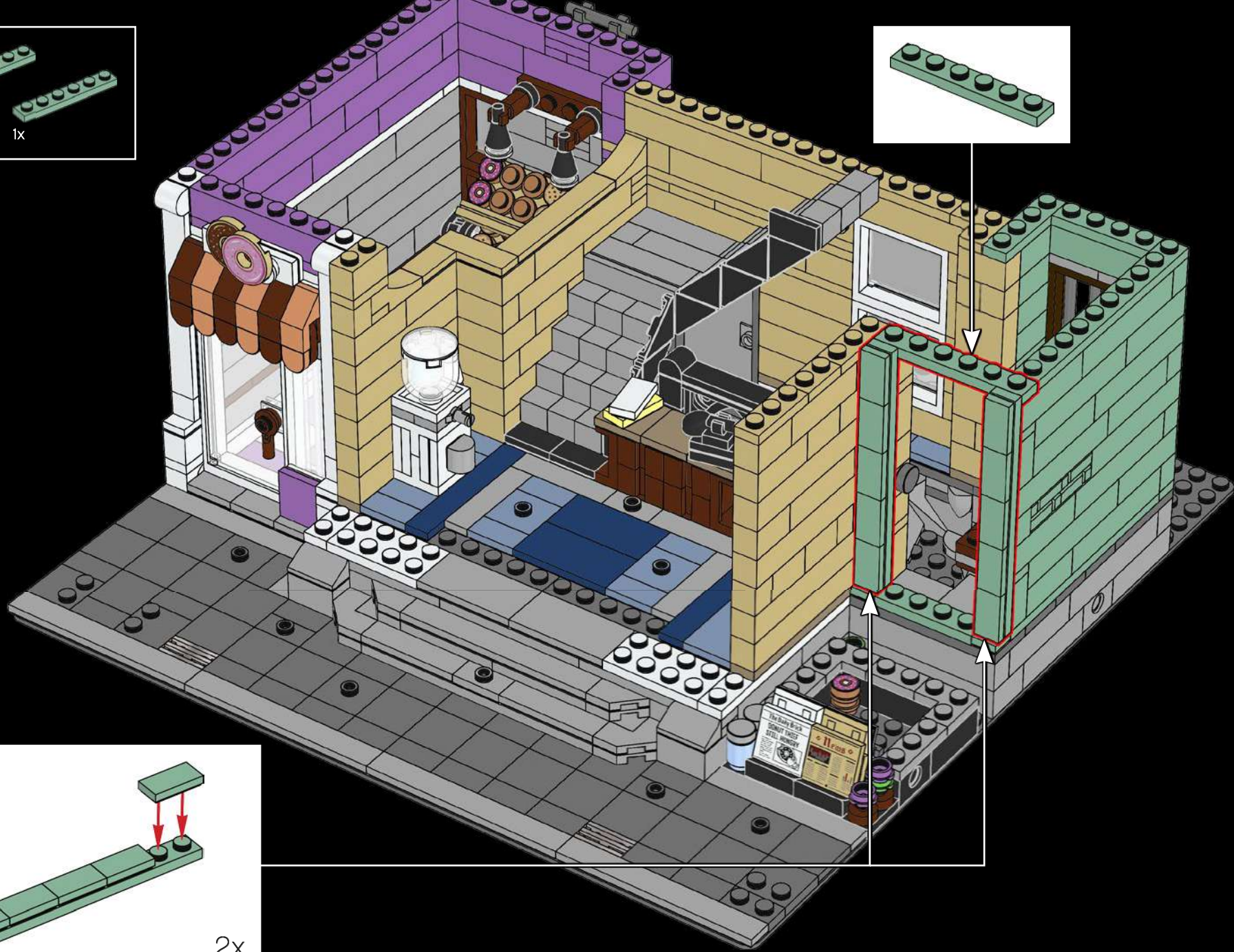

84

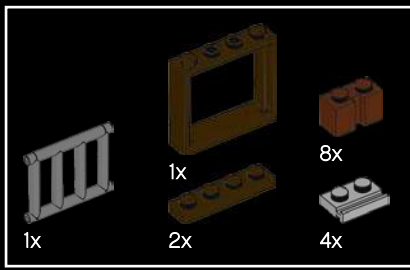

96

1

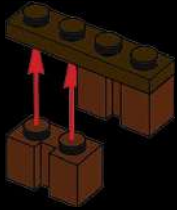

2



3

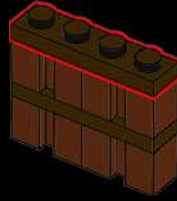

4



5

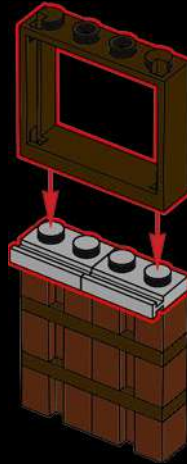

6

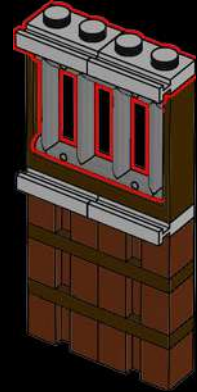

7

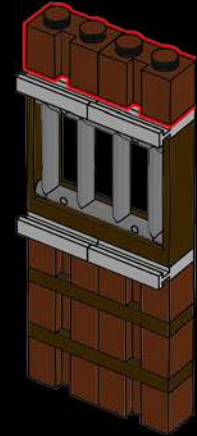



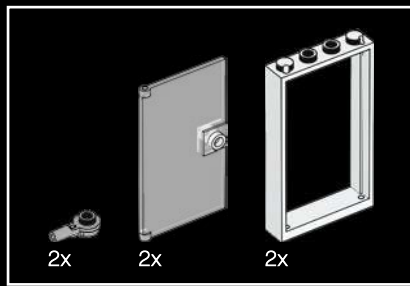

97

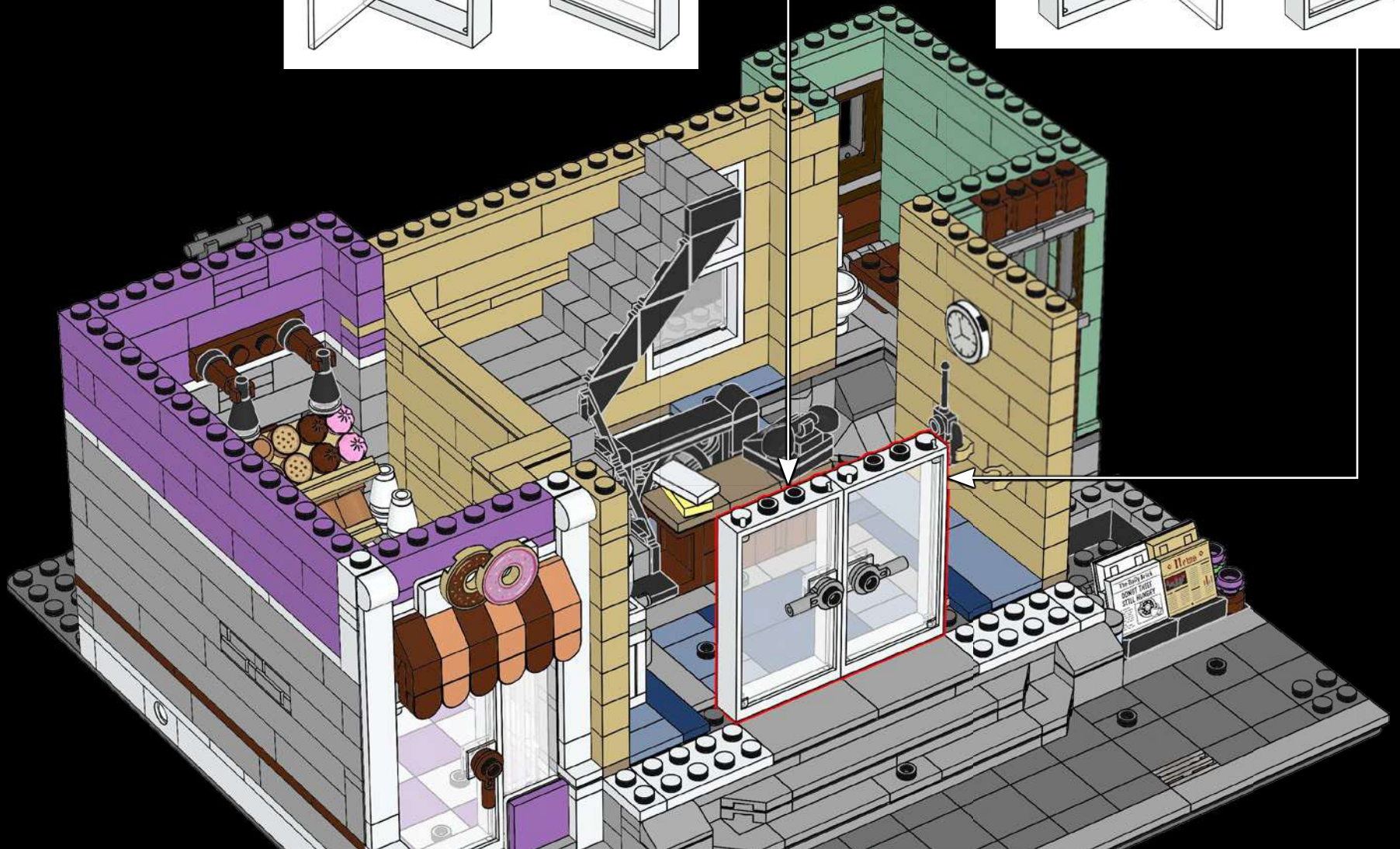
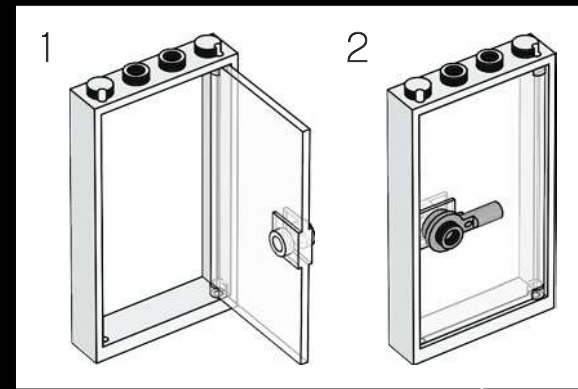
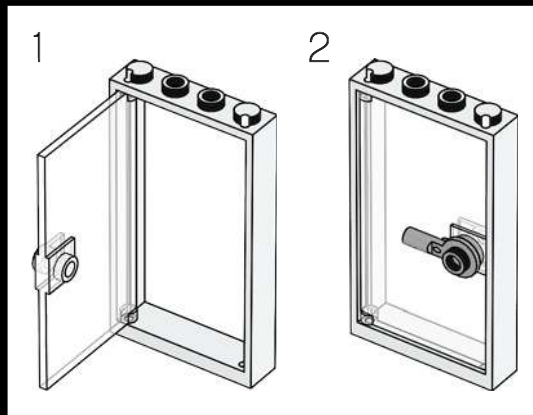



6x

98

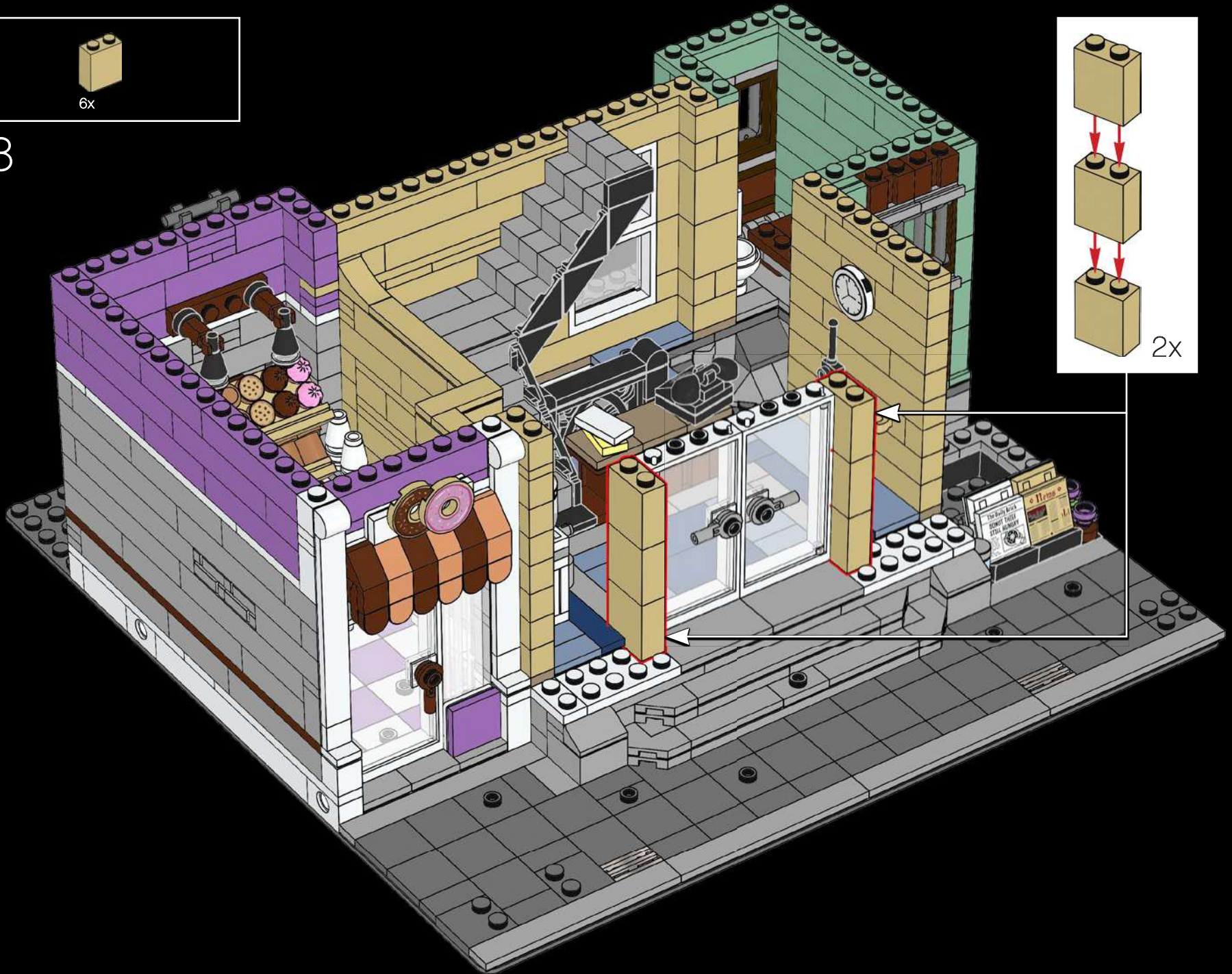

2x

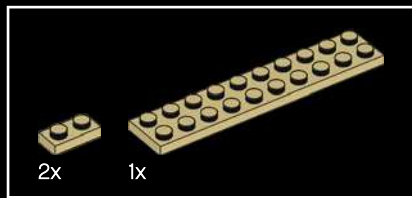

99

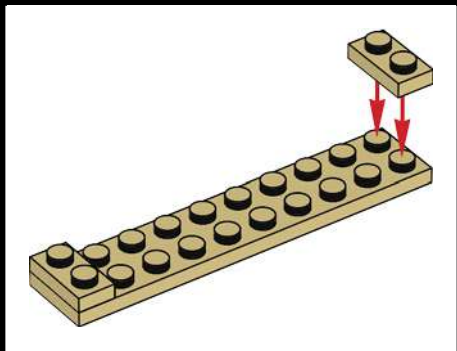
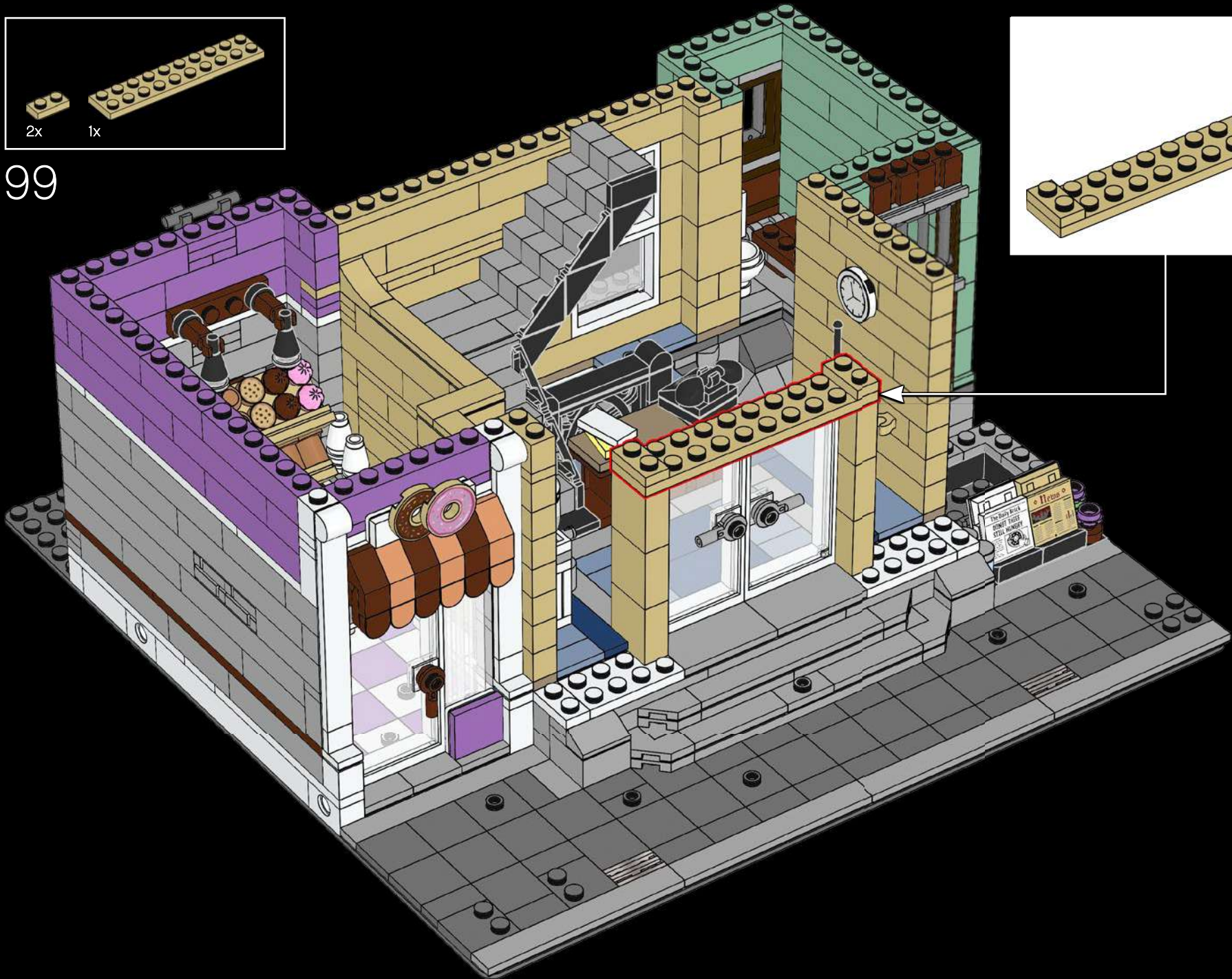

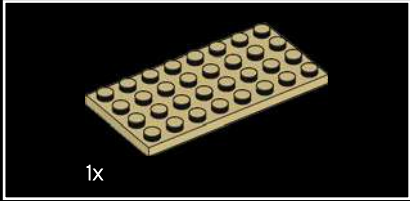

1x

100

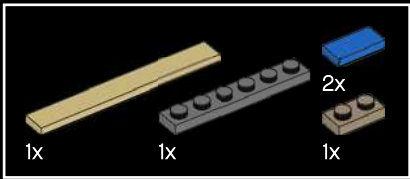
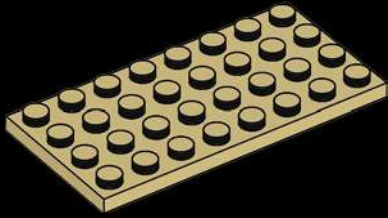

101

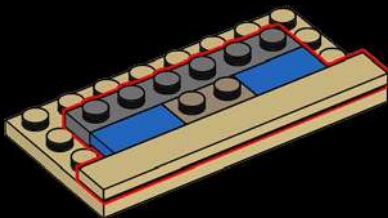

102

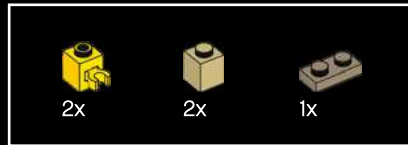
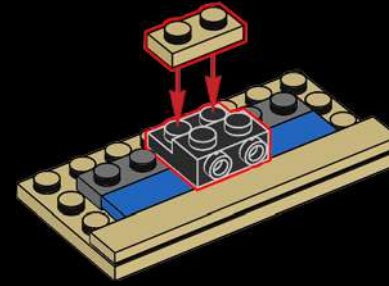

103

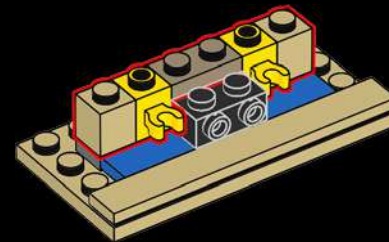

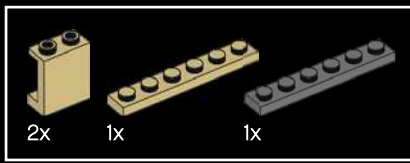

104

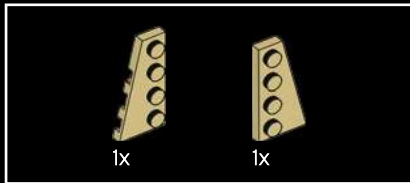
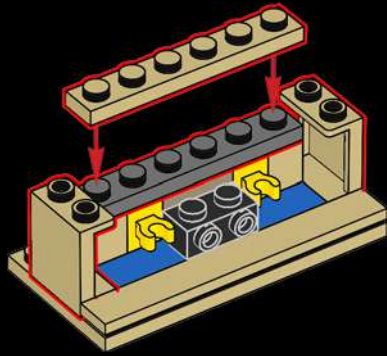

105

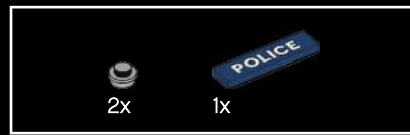
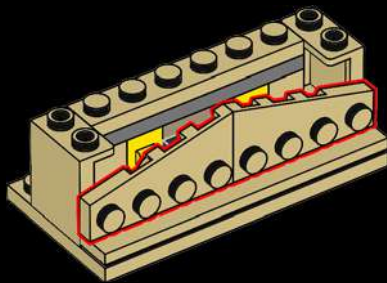

106

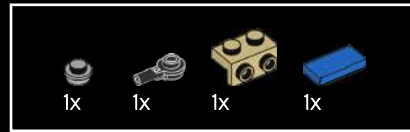

107

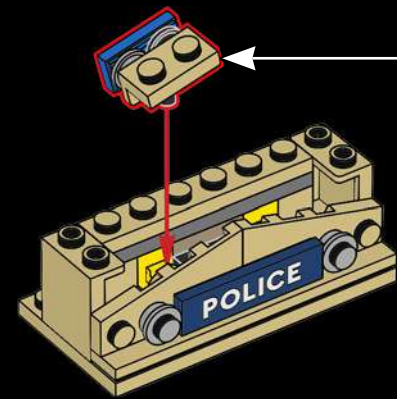



108

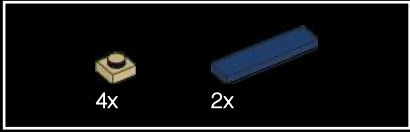
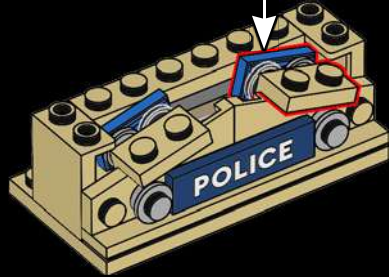

109

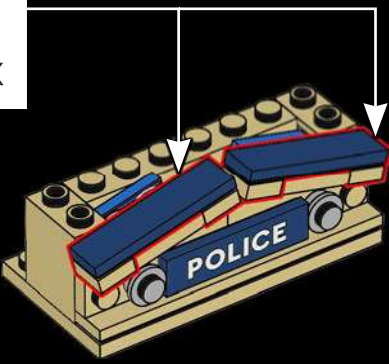
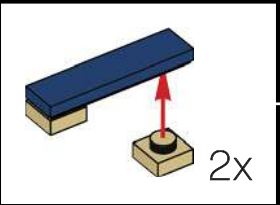

110



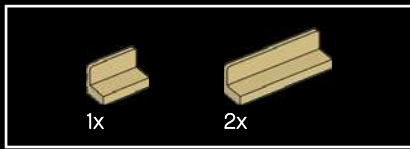

112



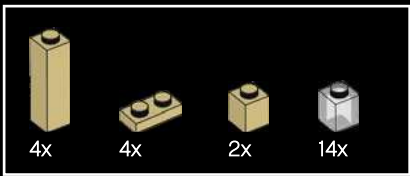

113

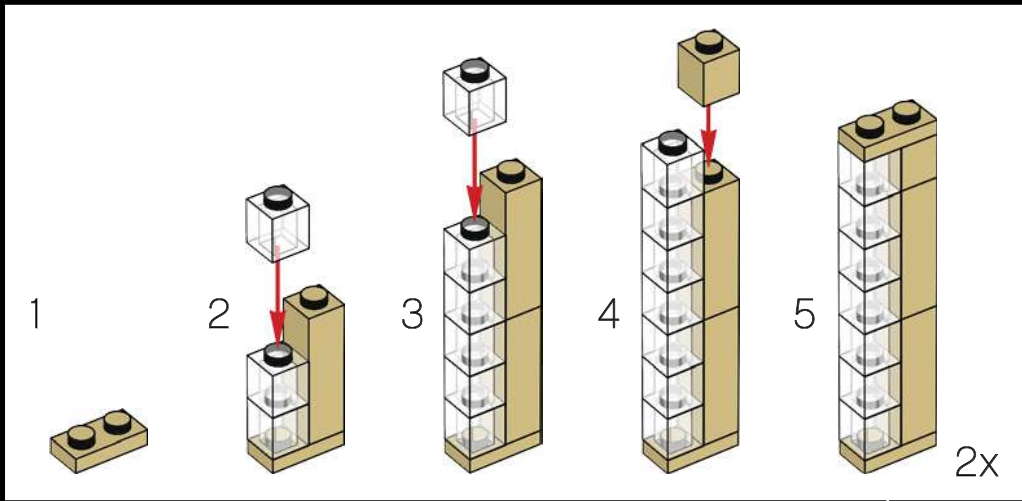

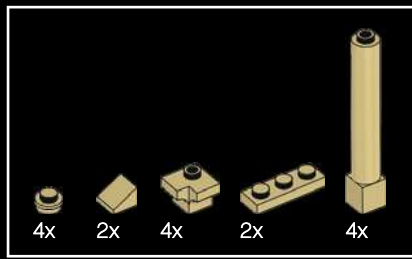

114

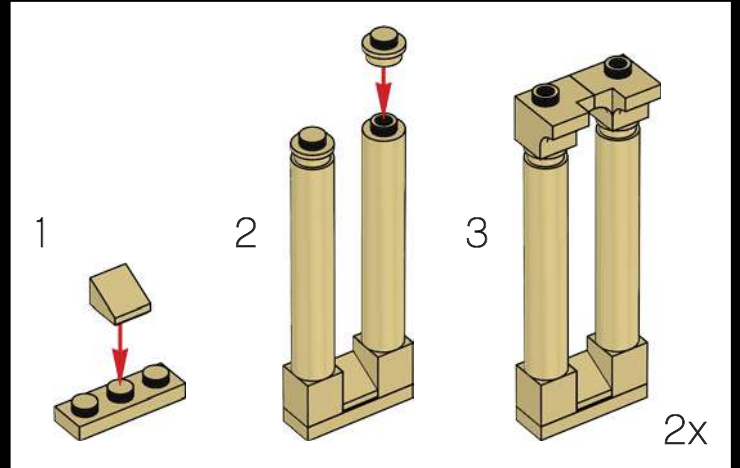
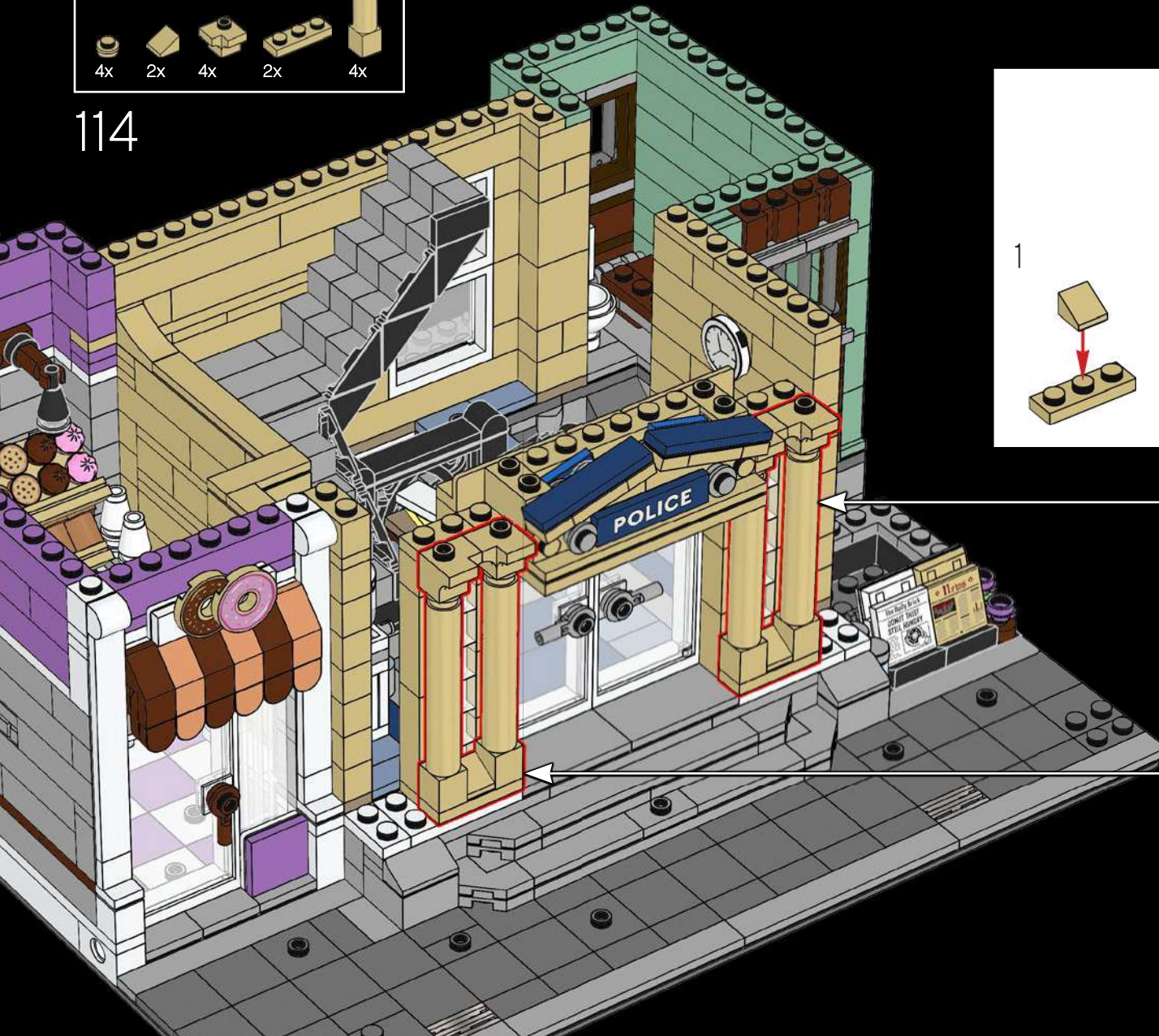

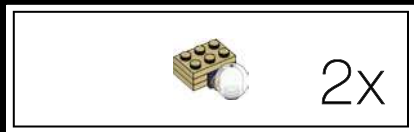

115

1



2



3

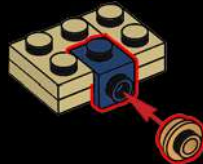

4



5

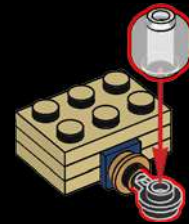

6



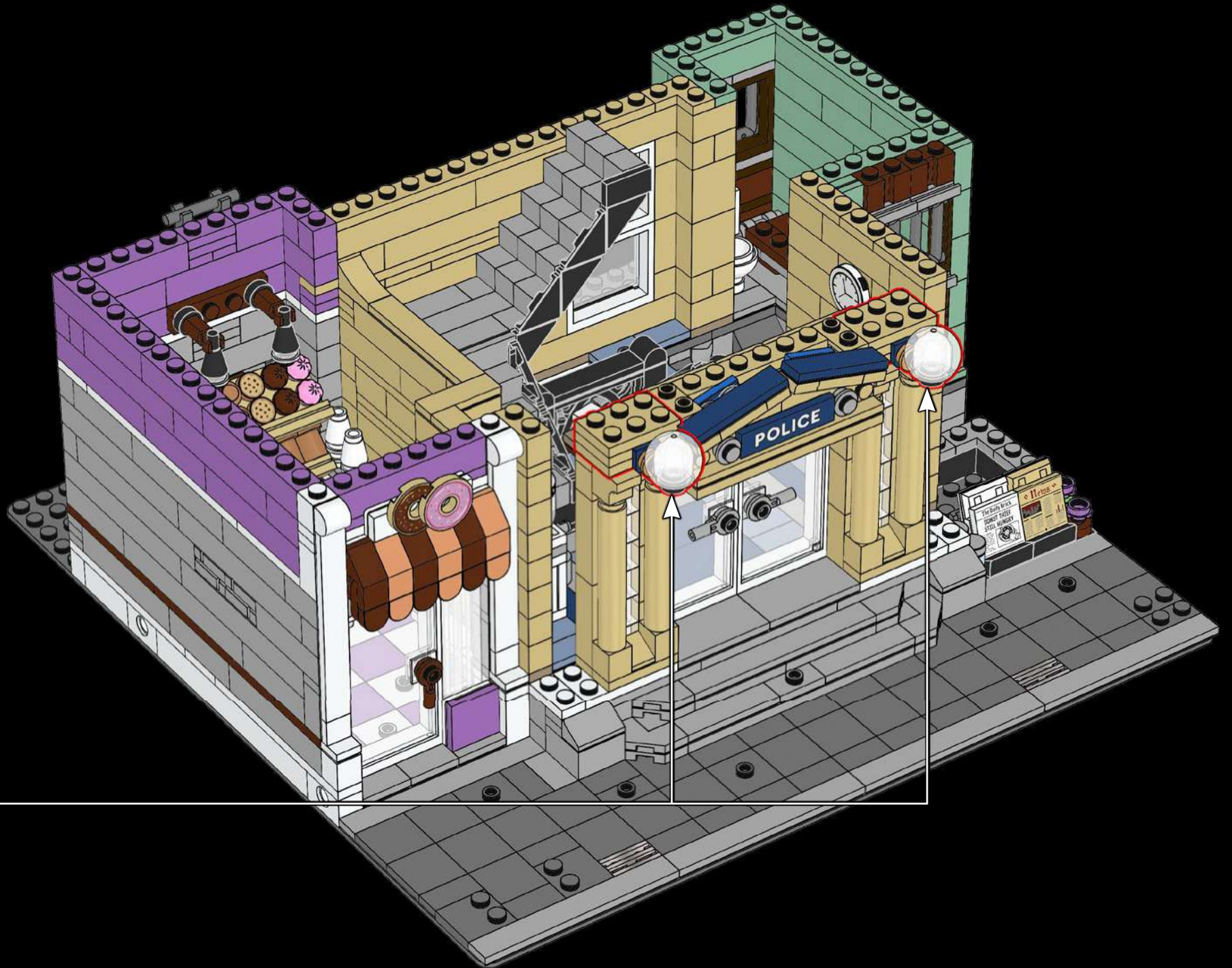

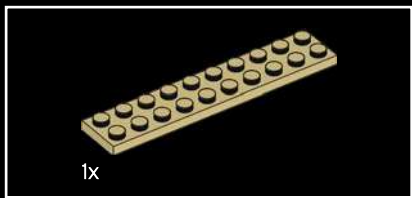

116

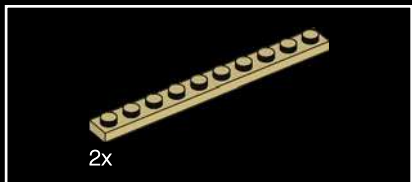
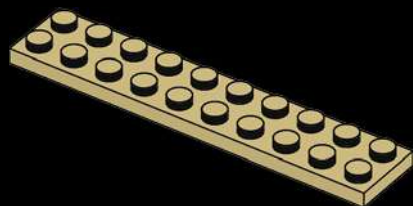

117

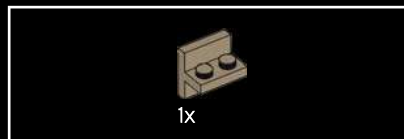
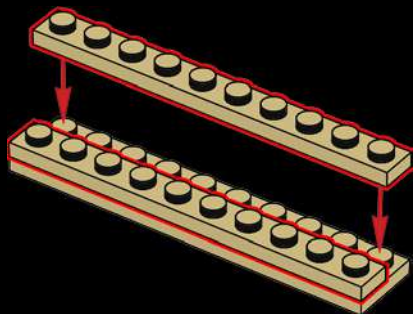

118

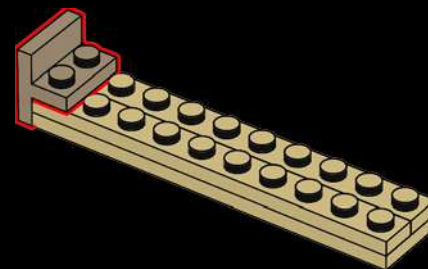

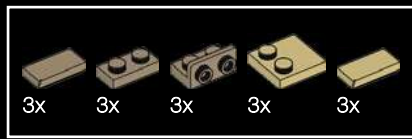

119

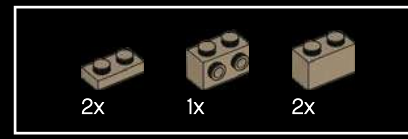
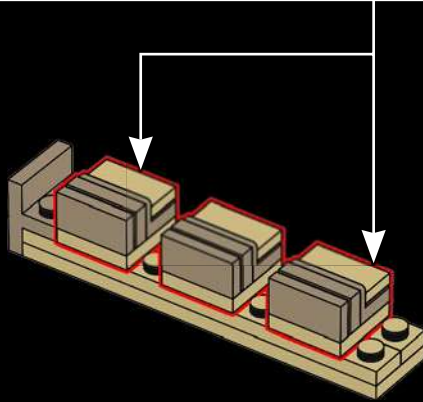
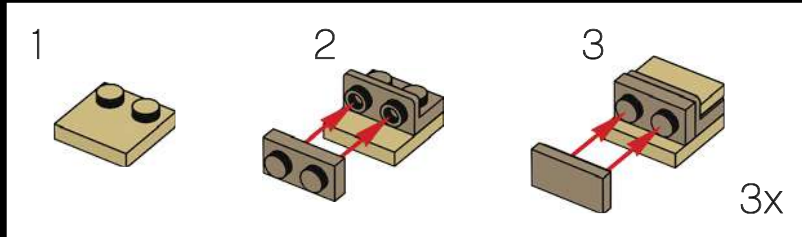

120

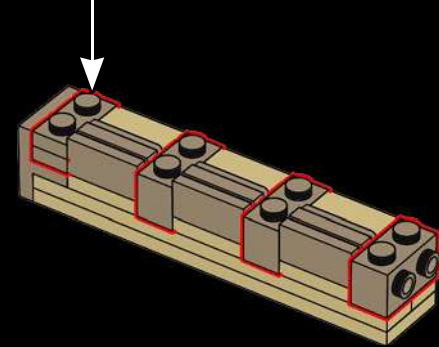
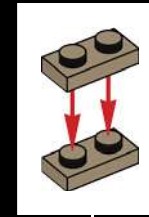

121

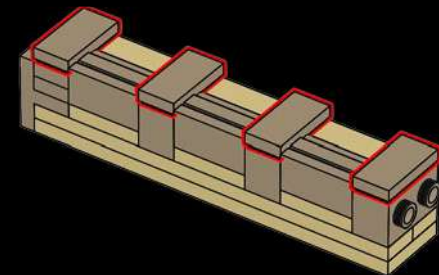

122

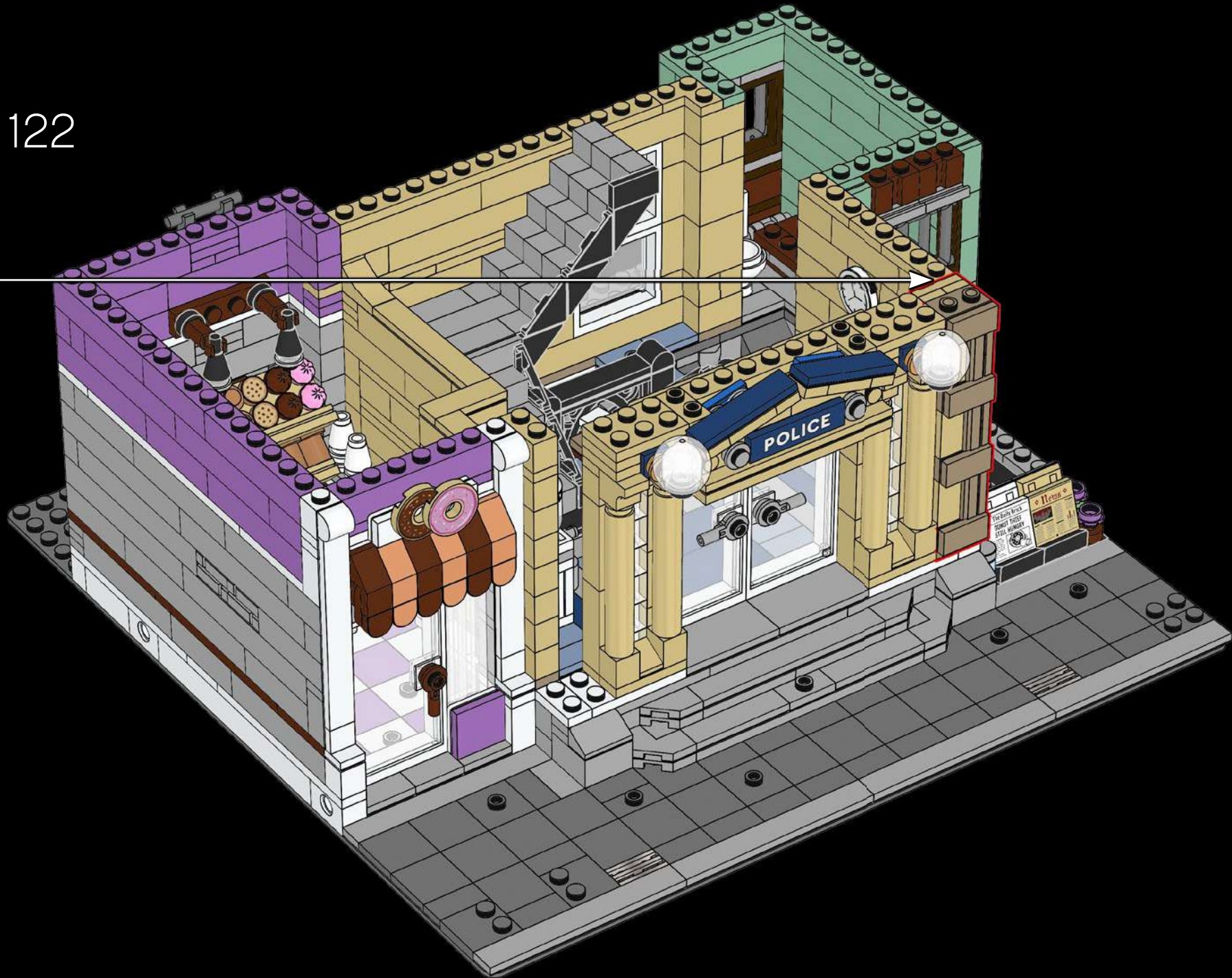

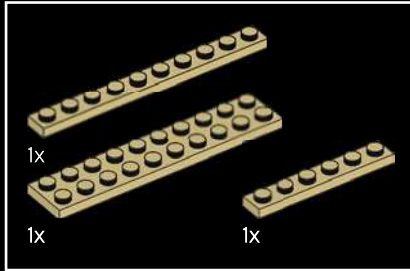
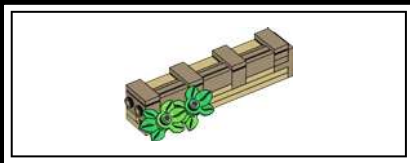

123

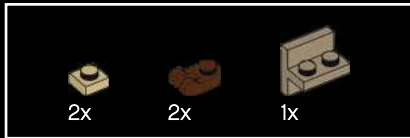
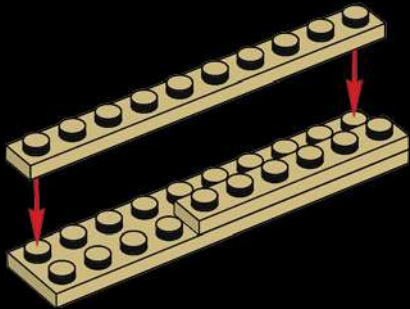

124

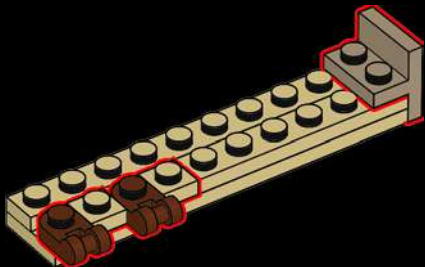

125

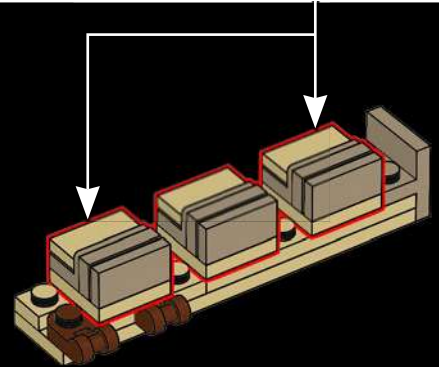
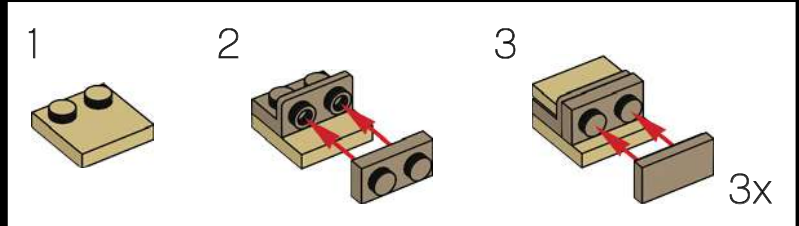

126

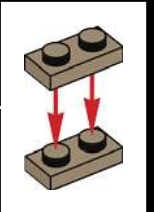
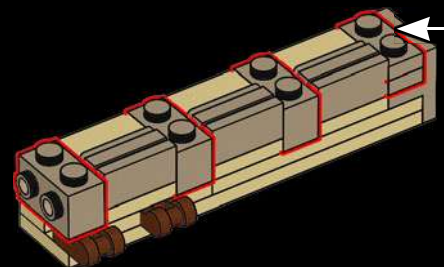



4x

127

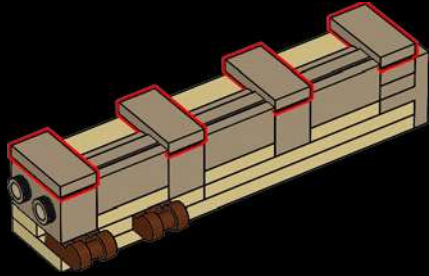

2x

128

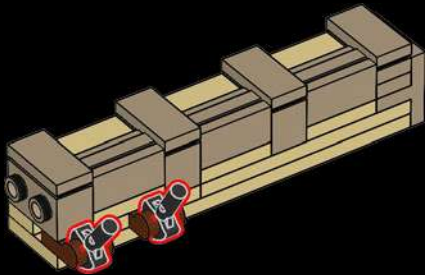

1x



1x

129

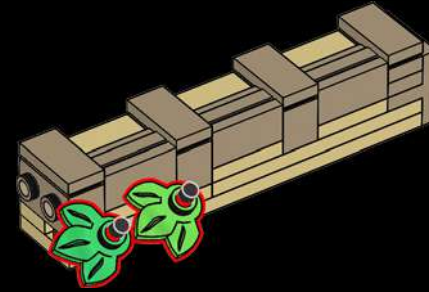

1x



1x

130

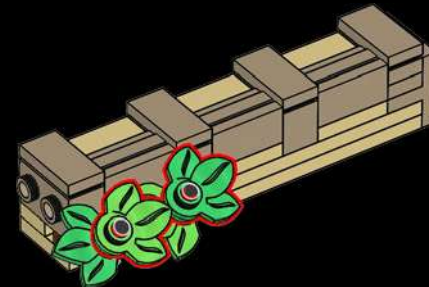

131

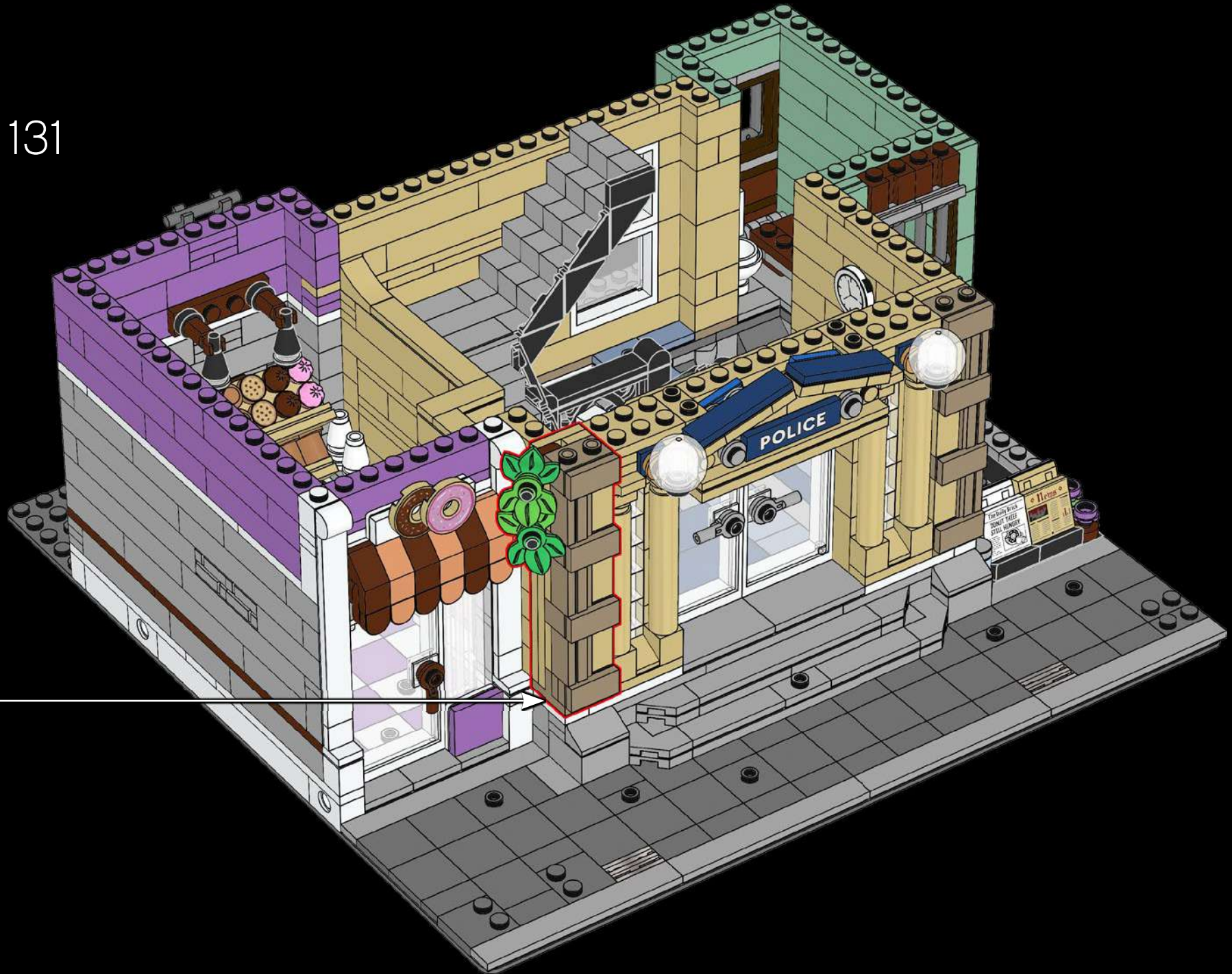

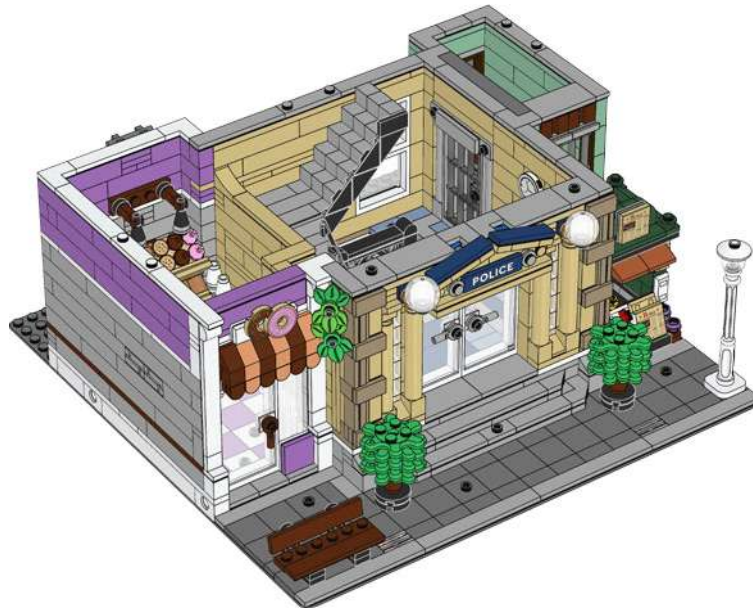

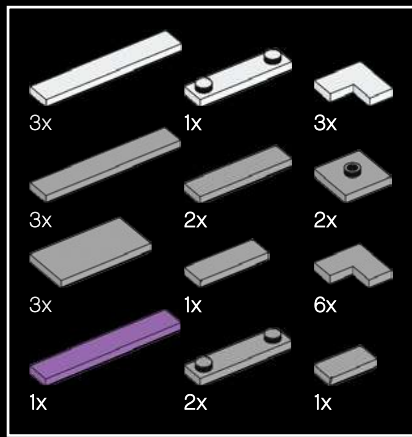

132

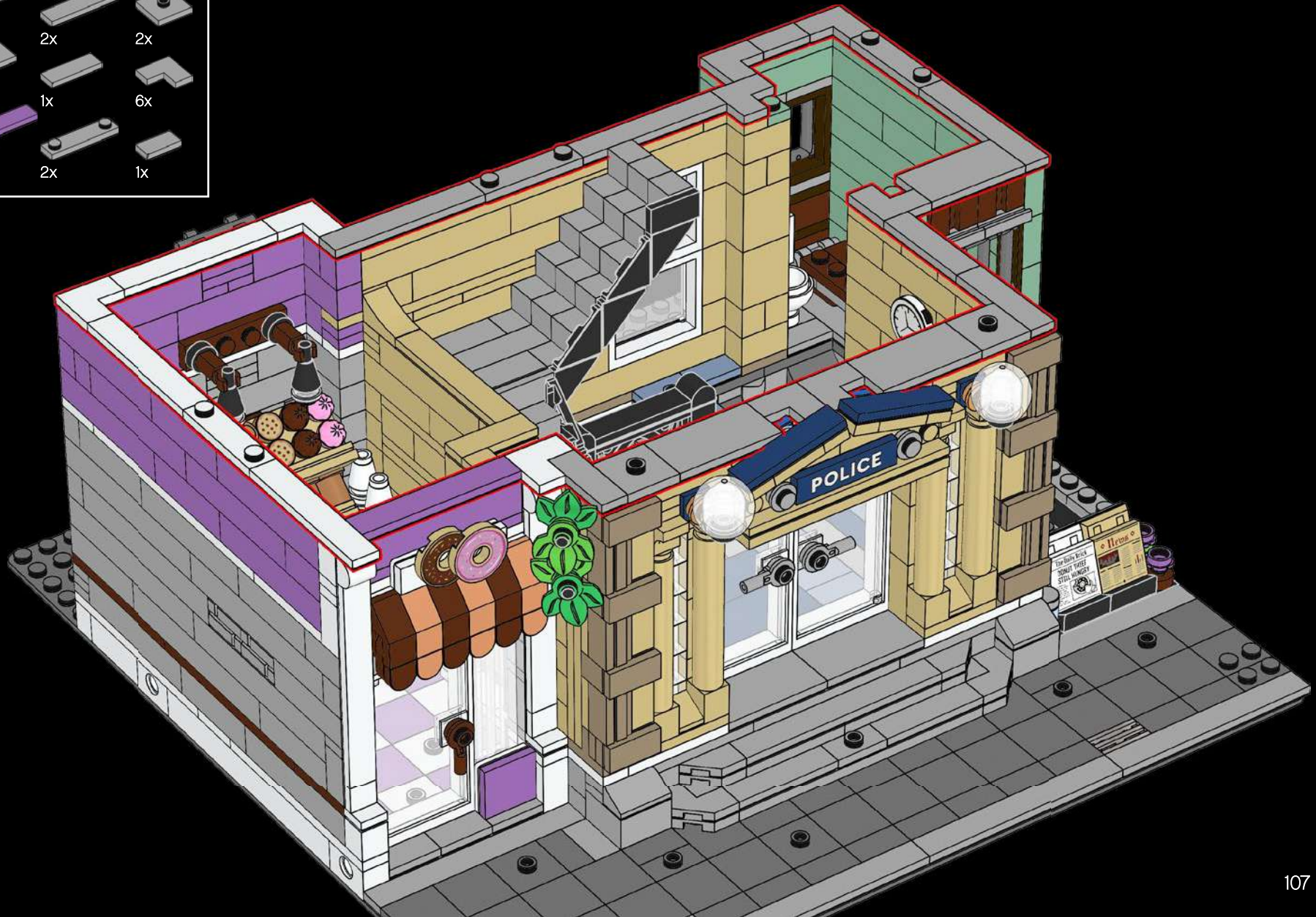

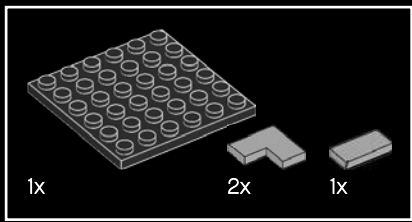

133

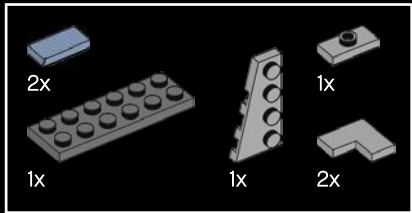
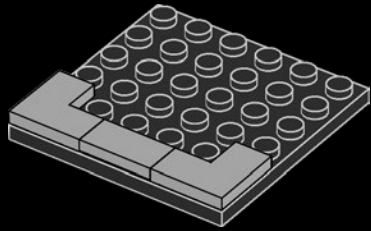

134

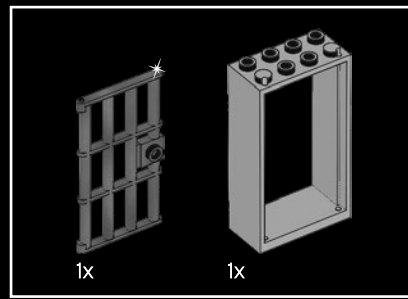
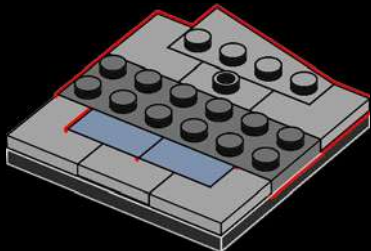

135

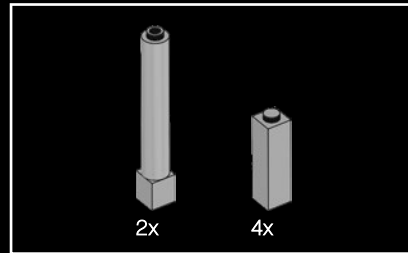
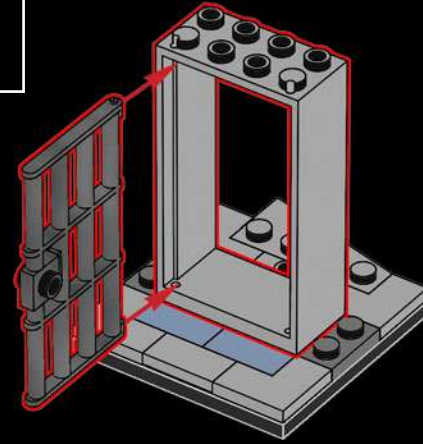

136

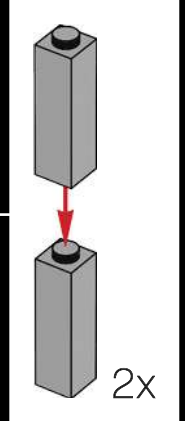
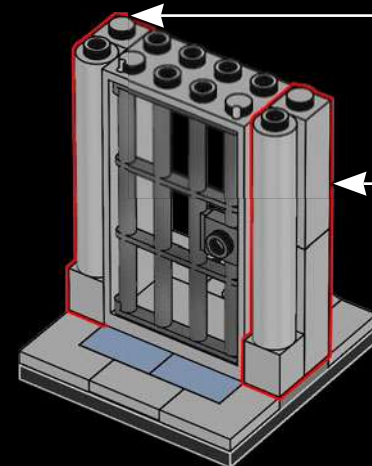

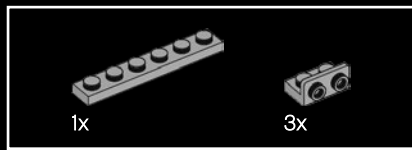

137

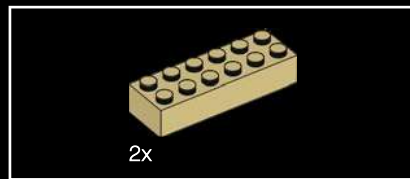
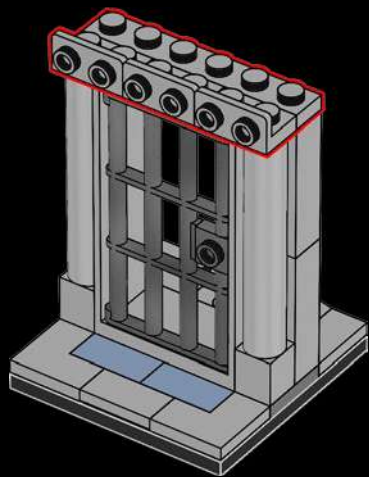

138

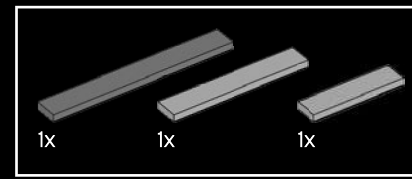
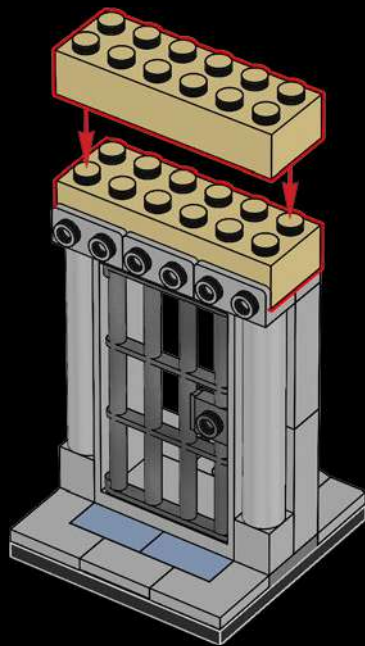

139

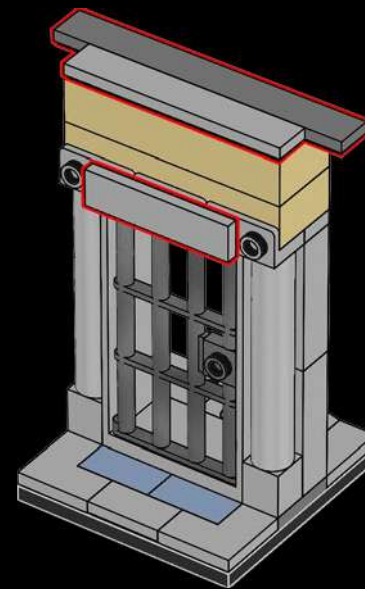

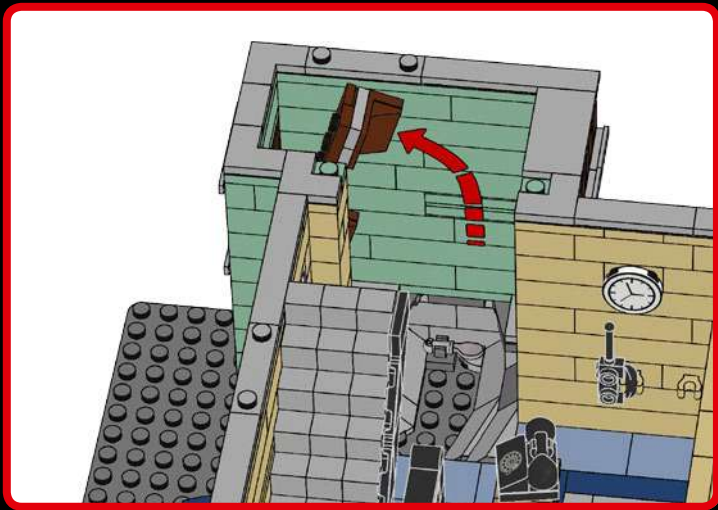

140



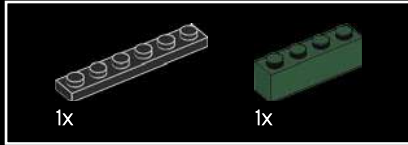
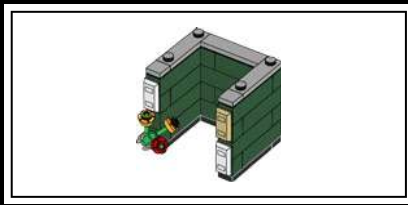

141

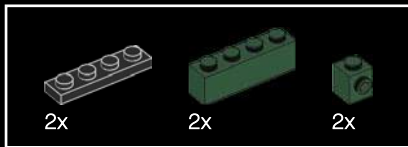
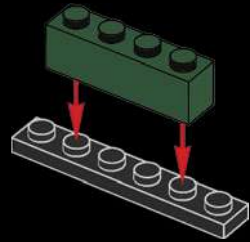

142

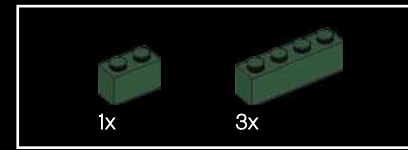
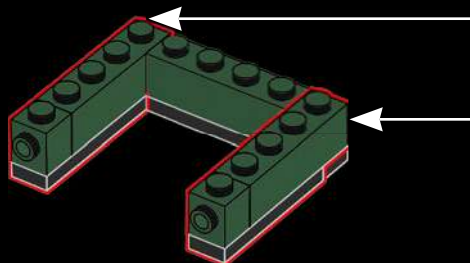
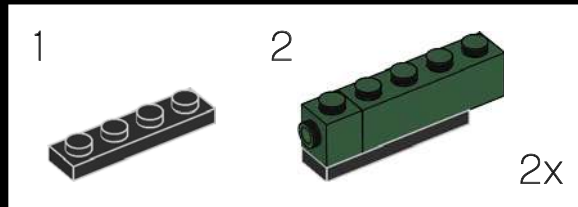

143

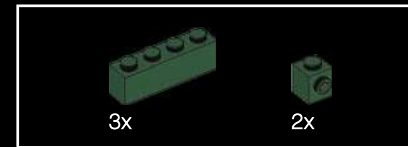
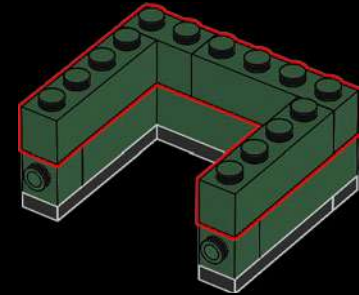

144

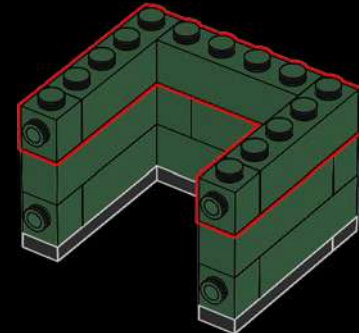

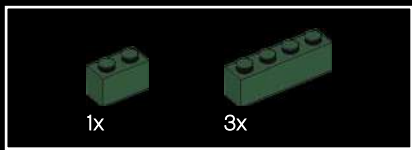

145

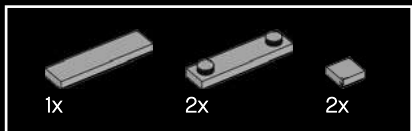
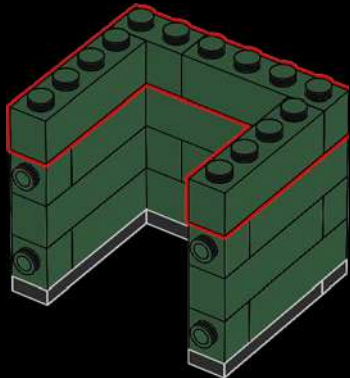

146

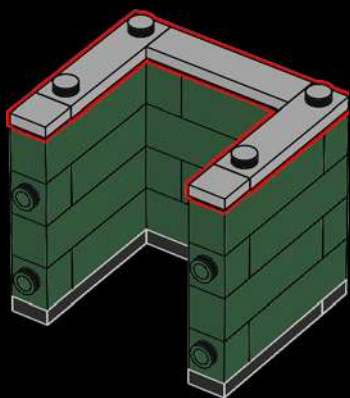

147

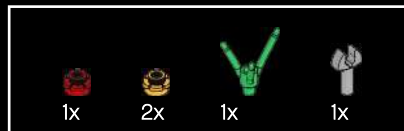
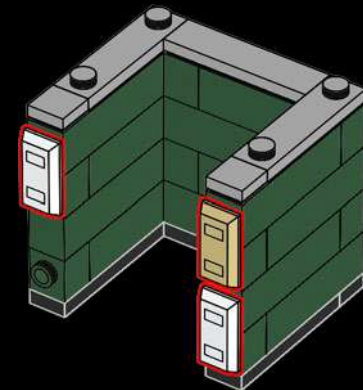

148

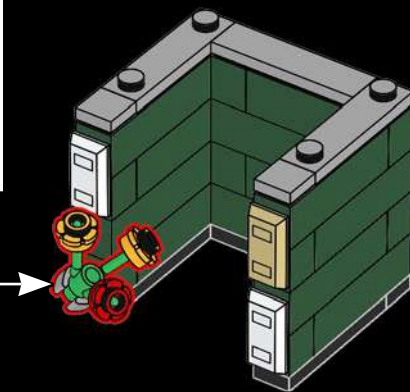
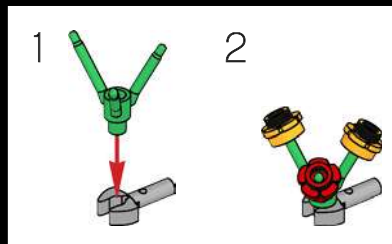

149



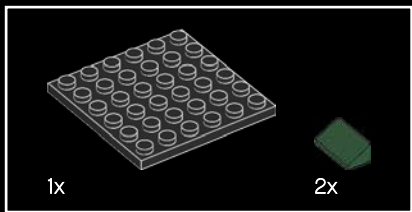

150

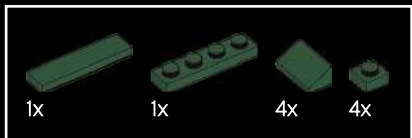
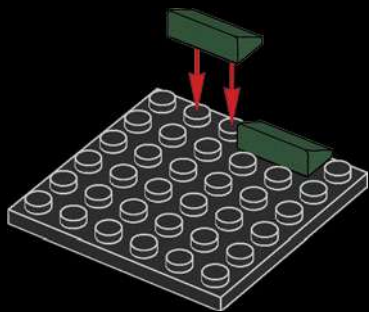

151

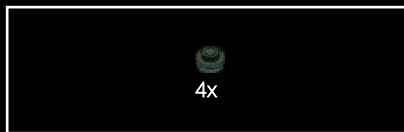
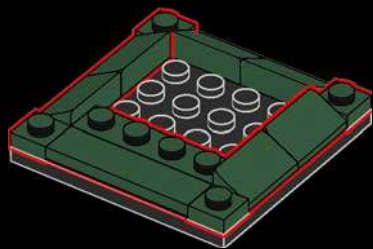

152

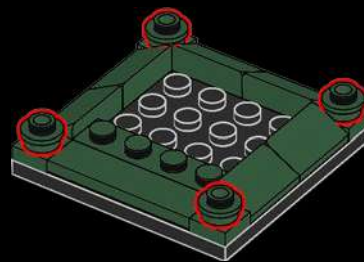

153

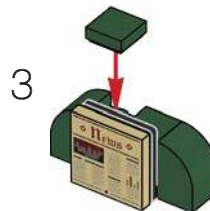
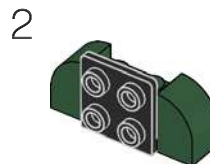
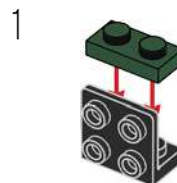
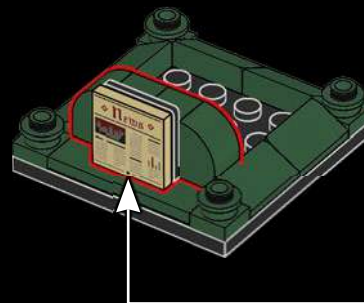

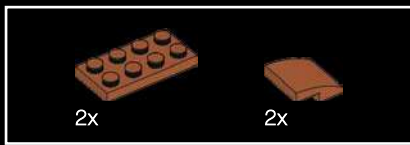

154

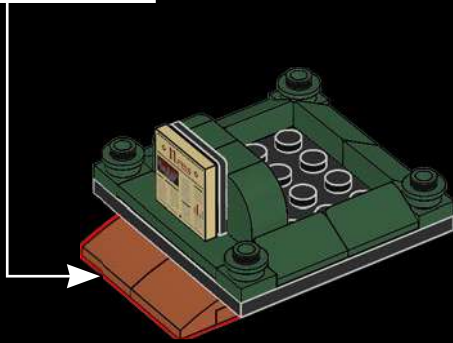
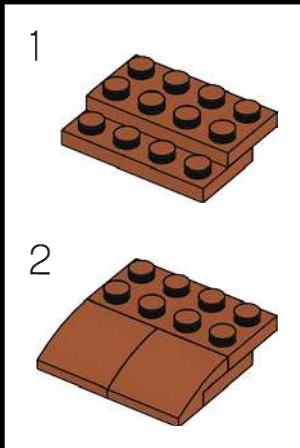

155



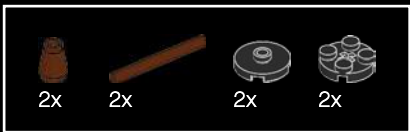

156

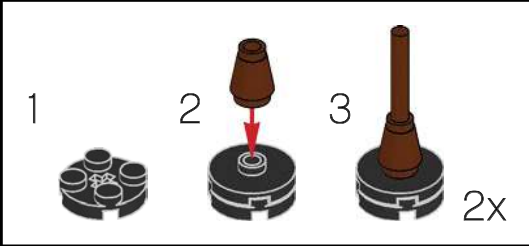

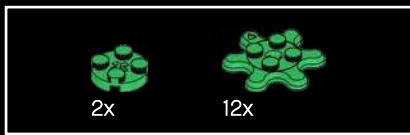

157

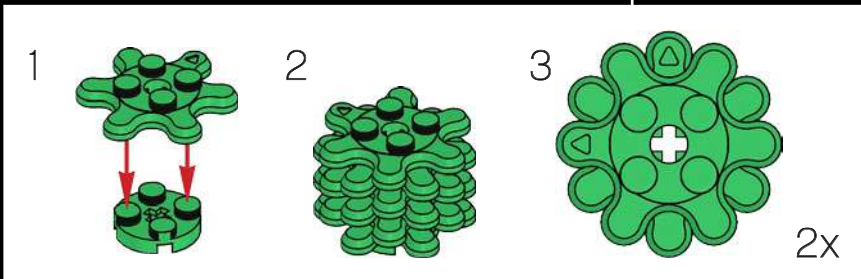

These convincing brick-built trees were created with new gear parts!

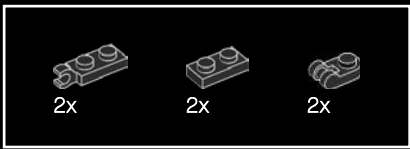

158

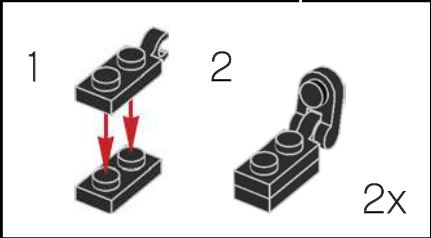

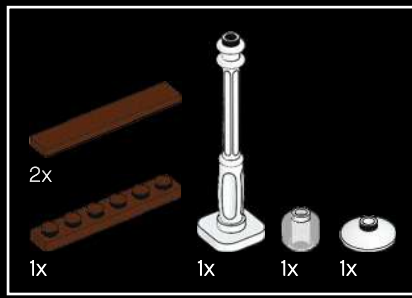

159

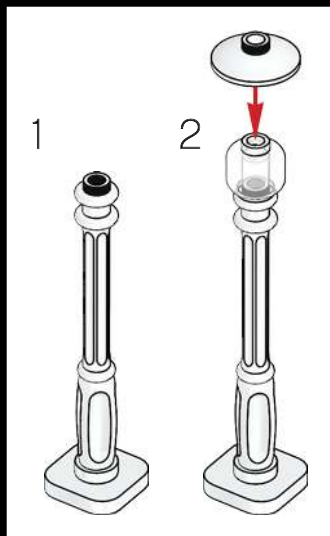

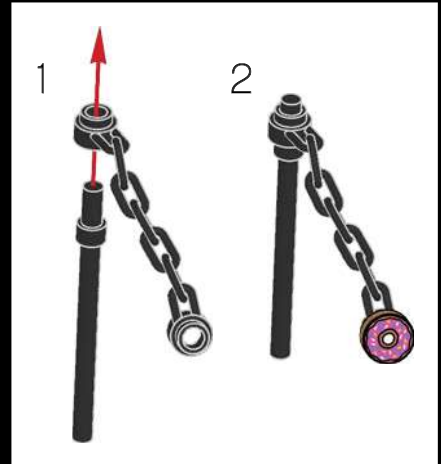
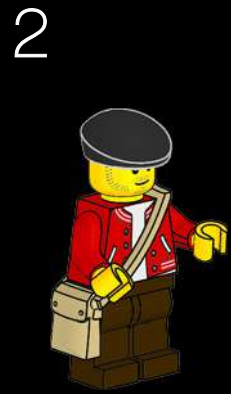
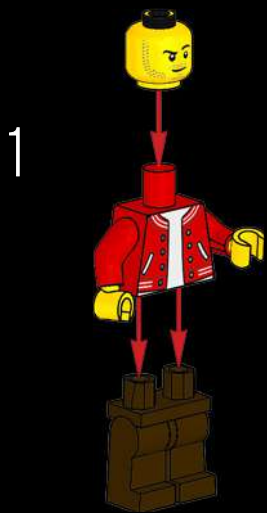
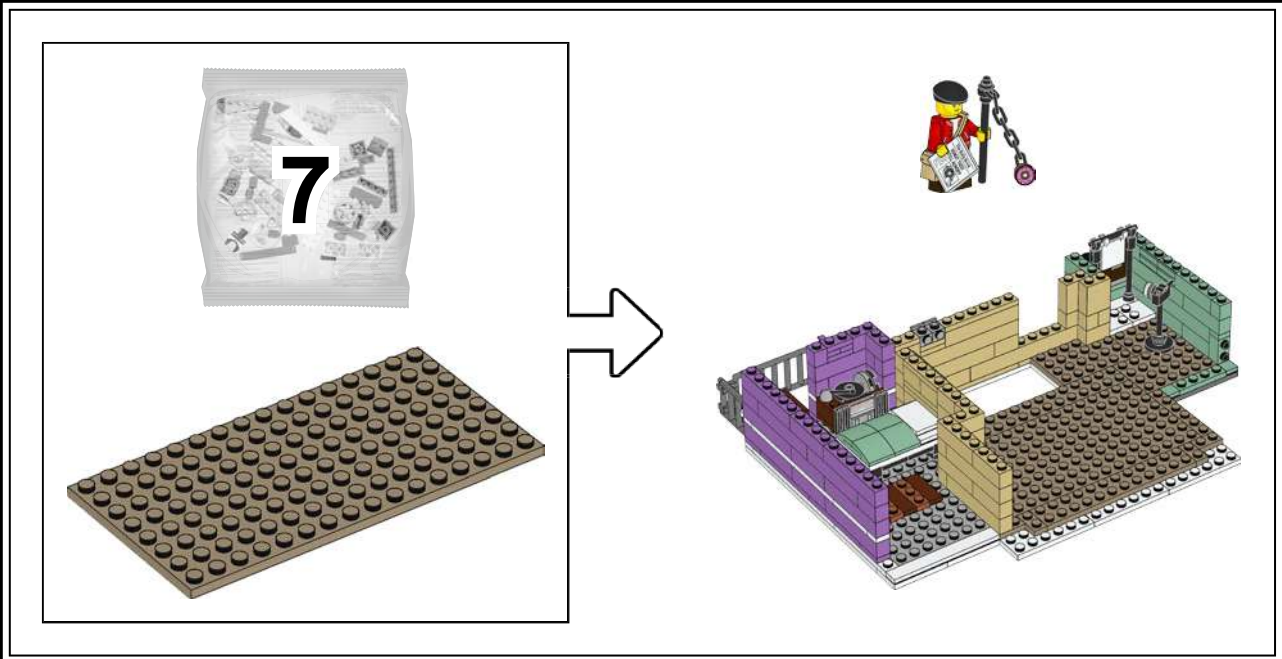

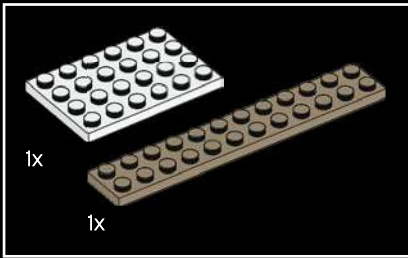

160

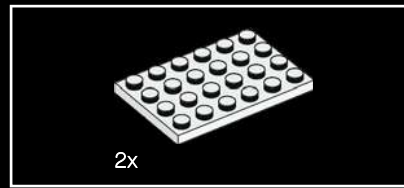
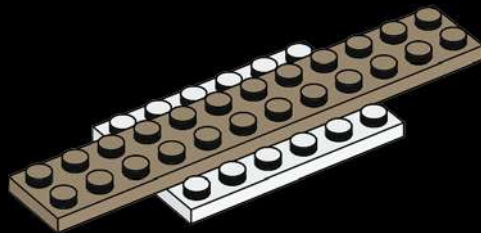

161

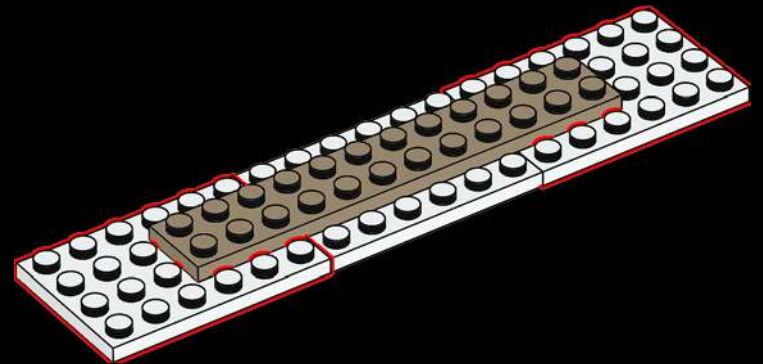

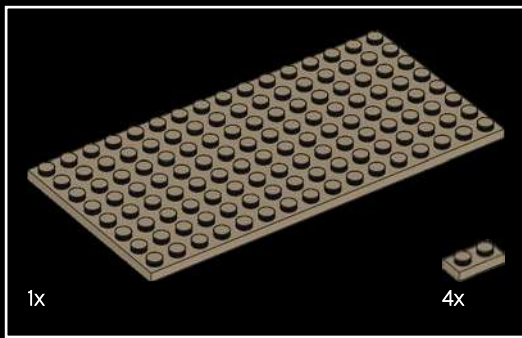

162

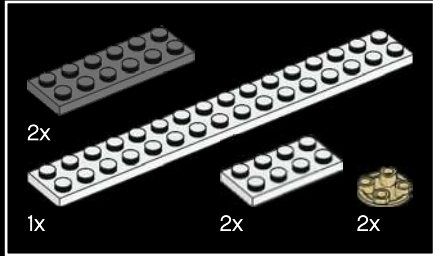
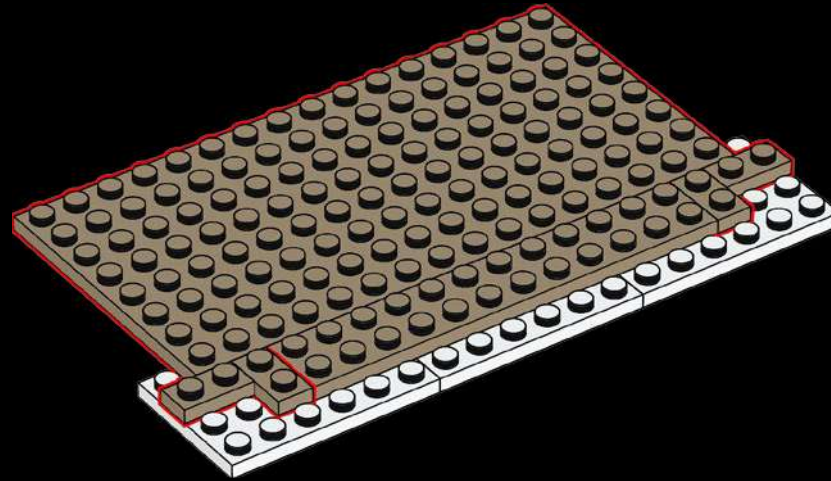

163

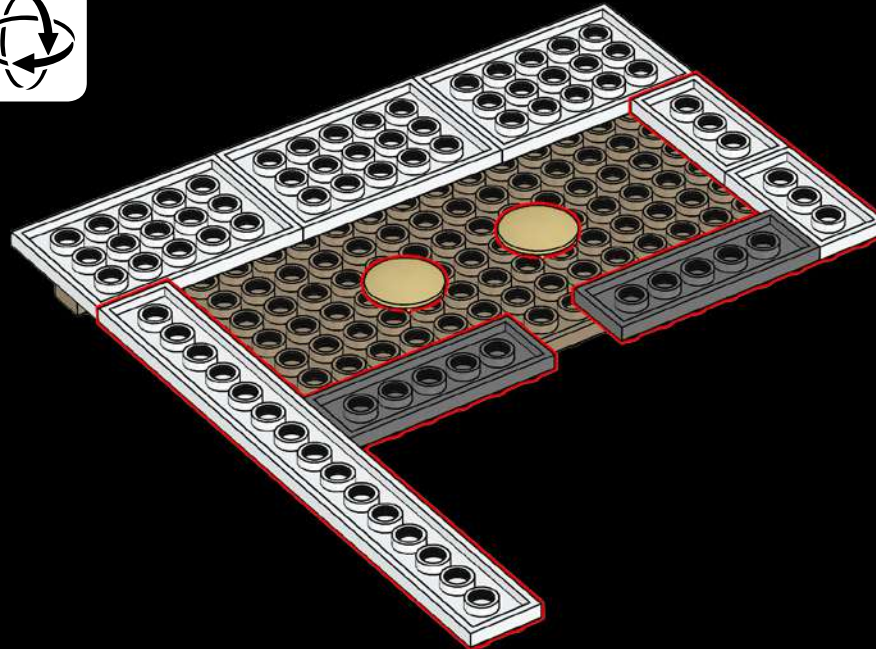

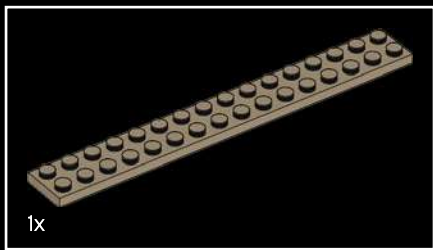

1x

164

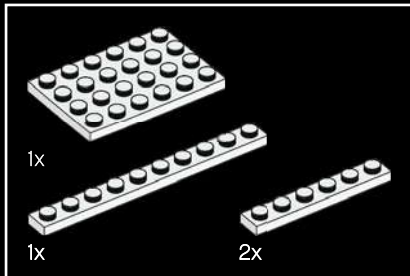
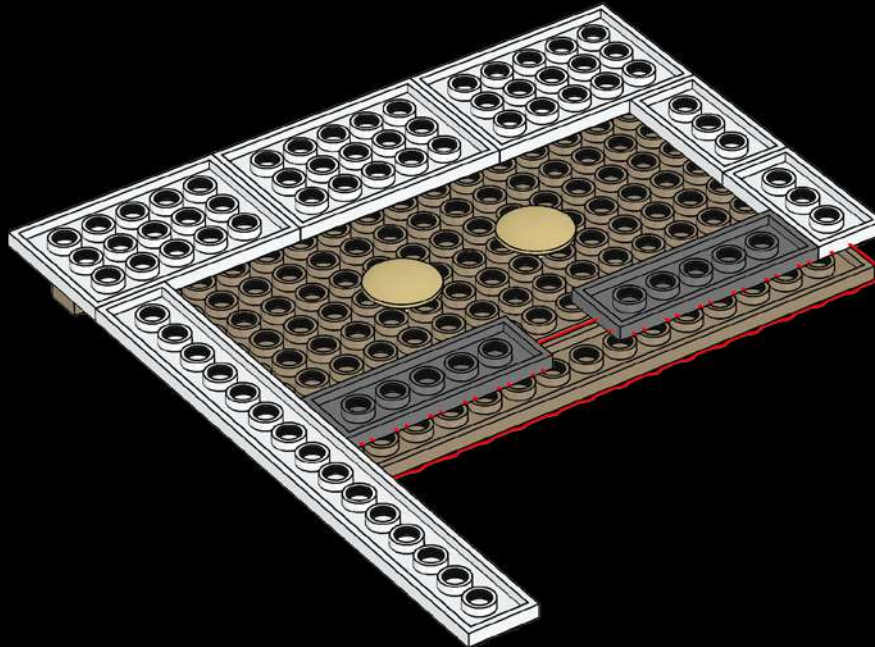

1x

1x

2x

165

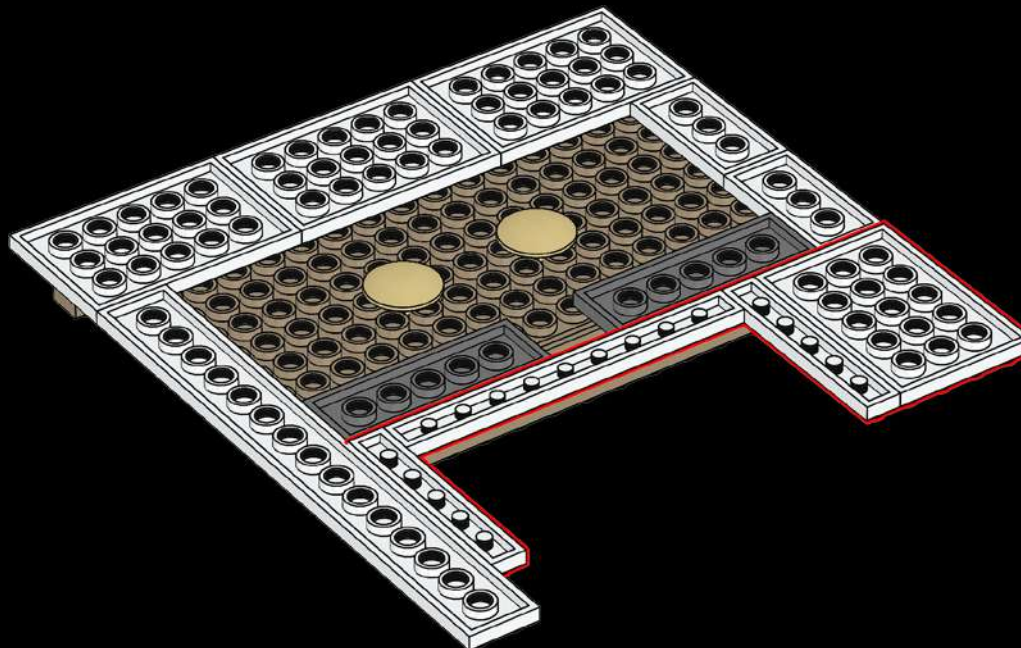

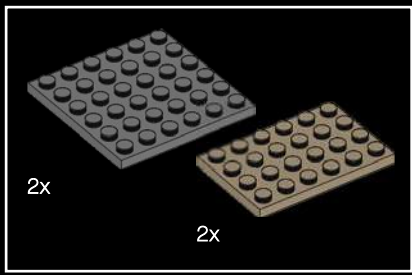

166

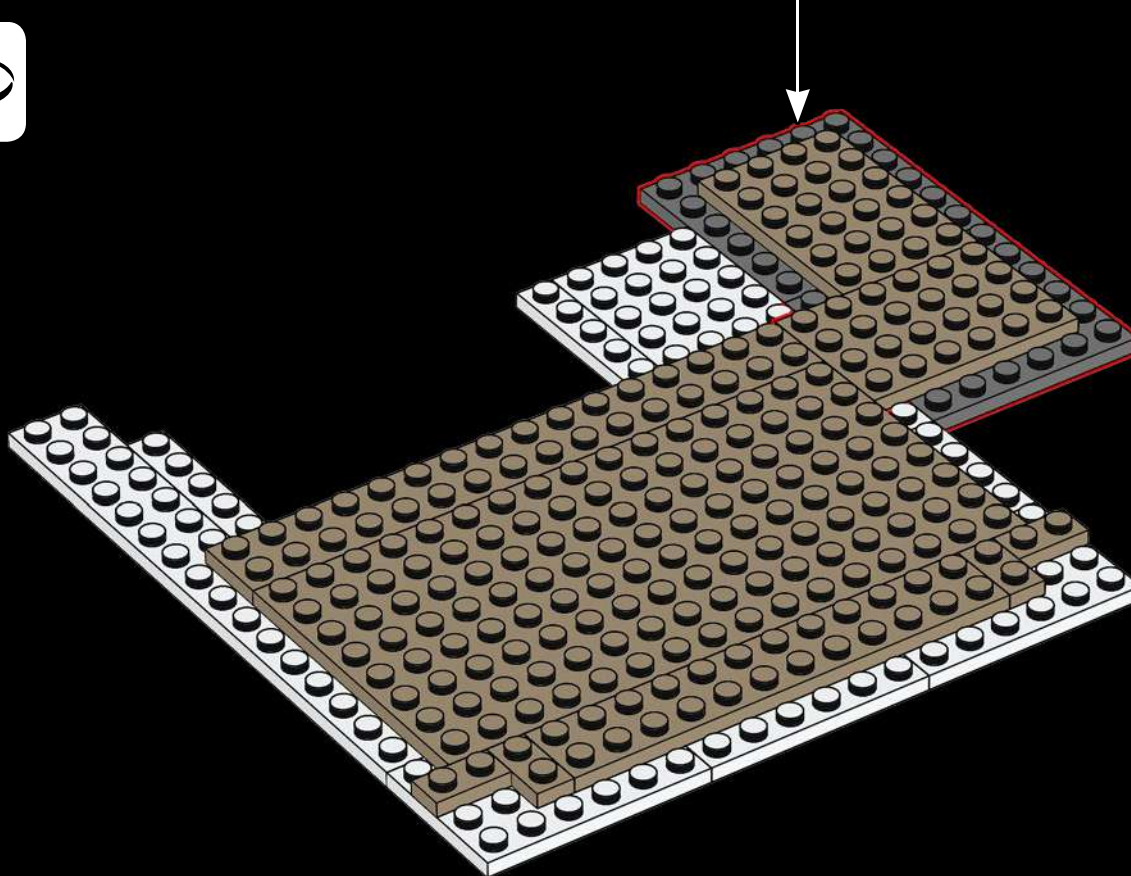
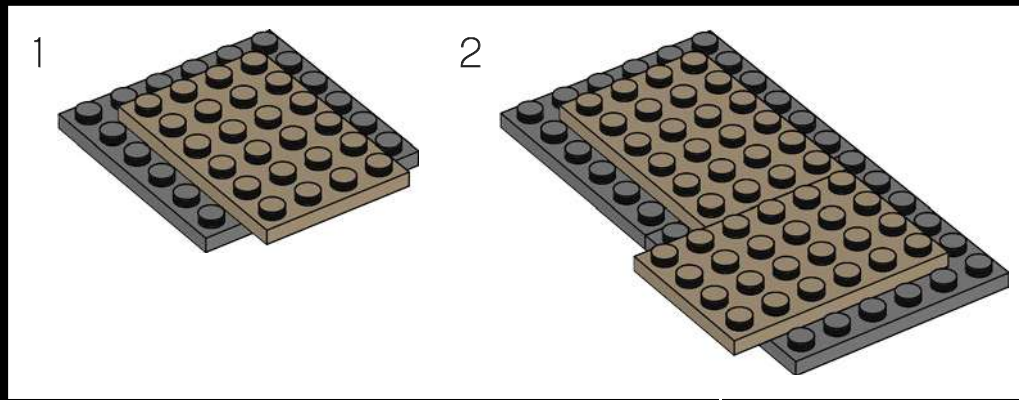

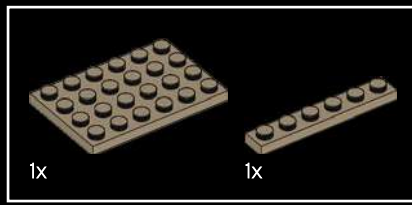

167

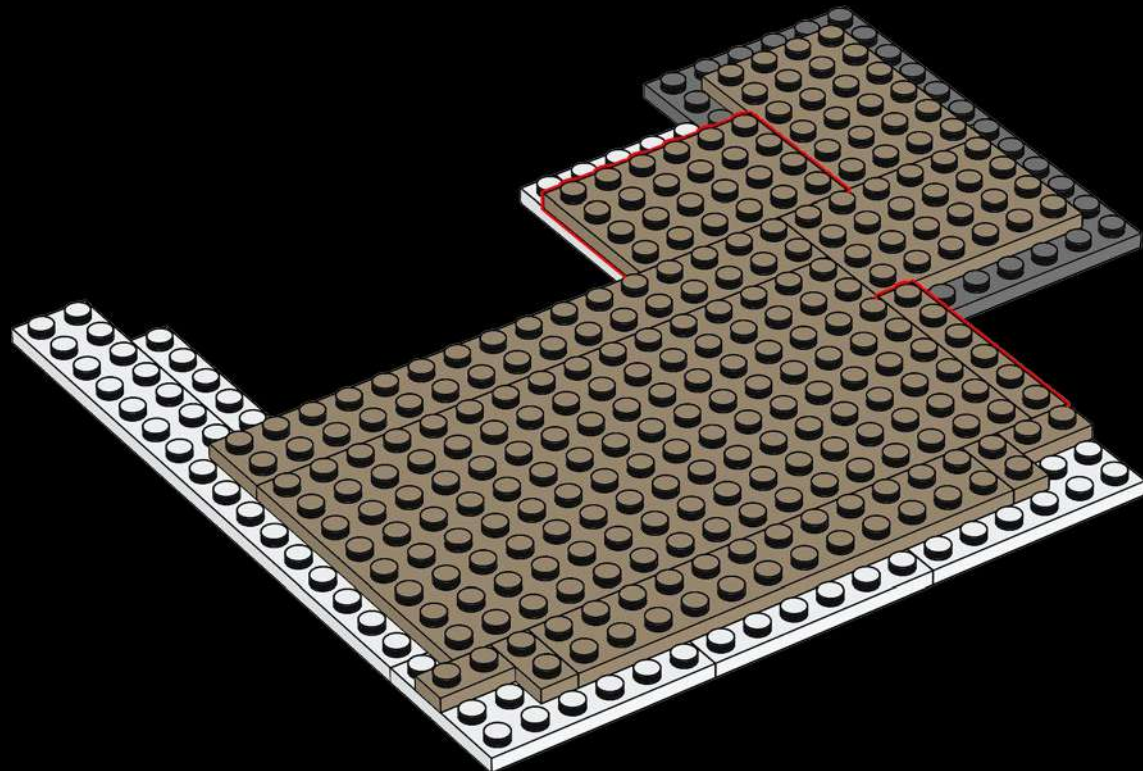

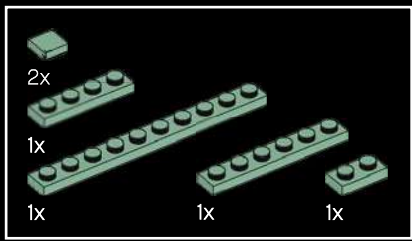

168

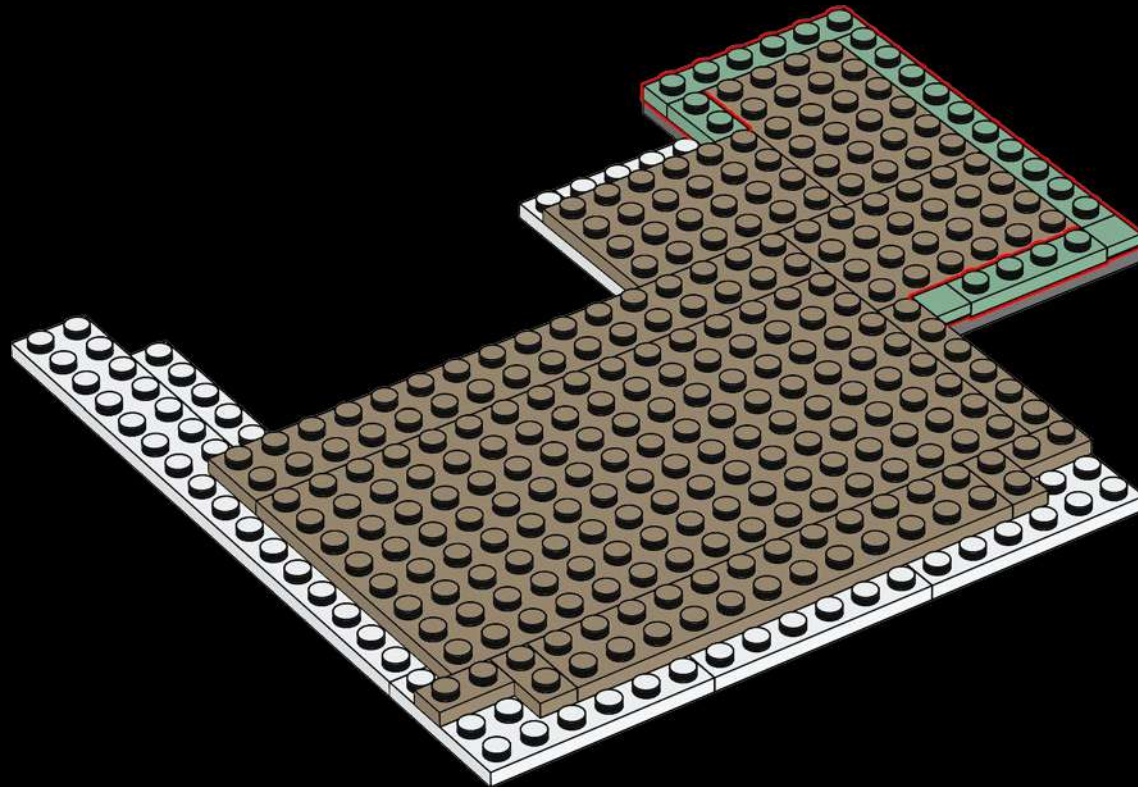

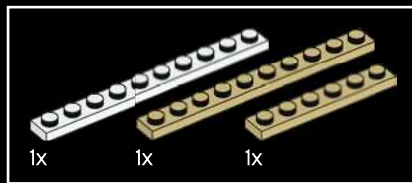

169

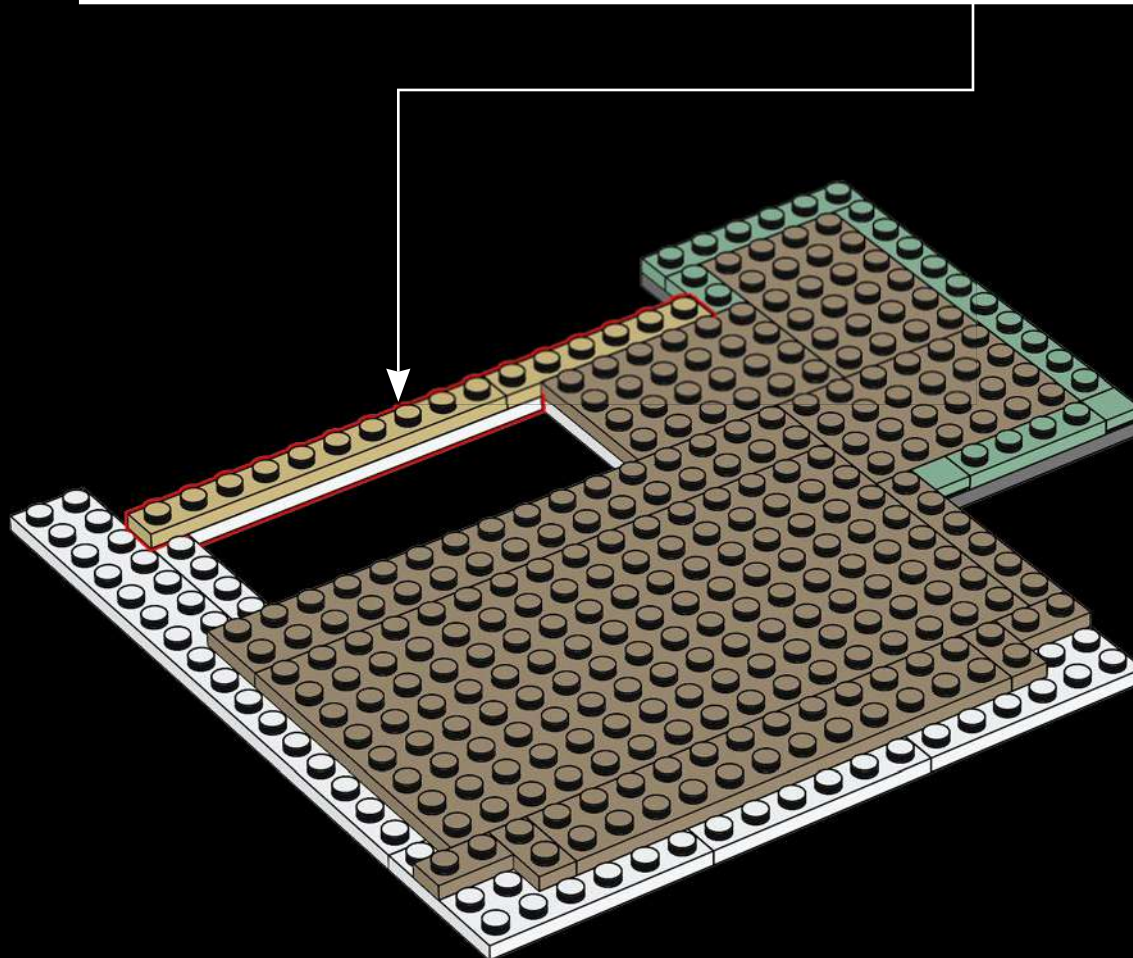
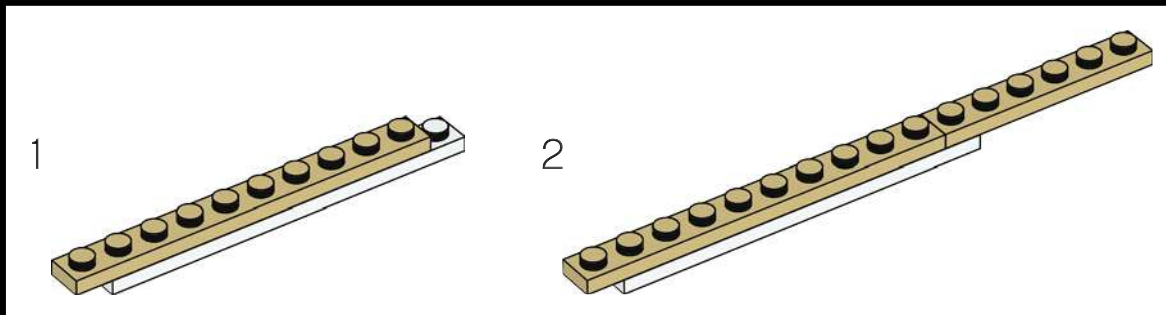

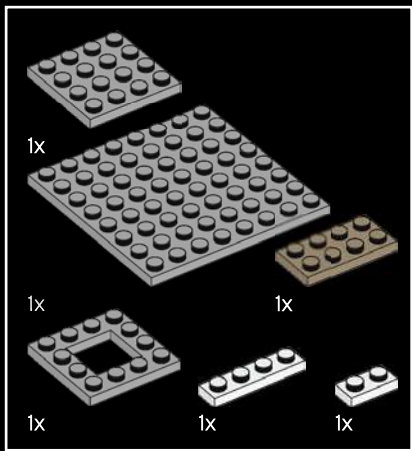

170

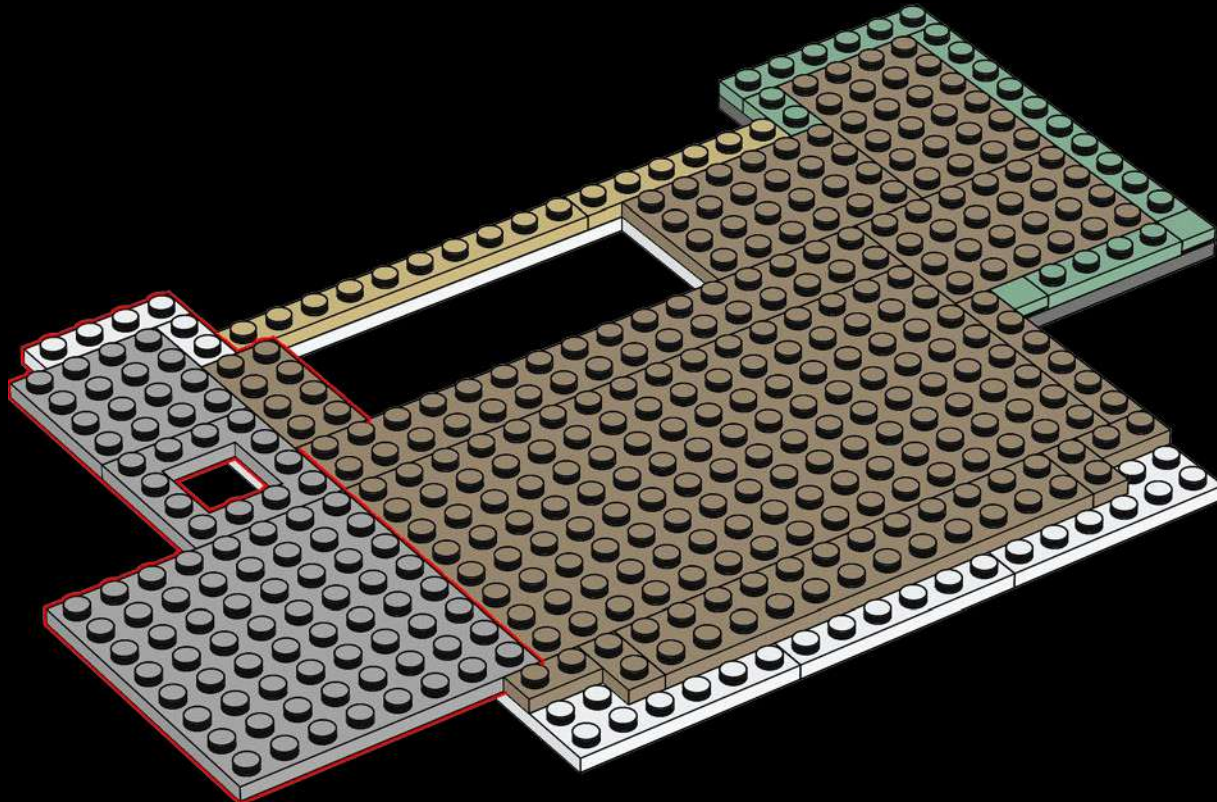

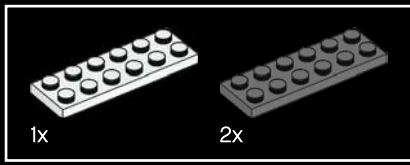

171

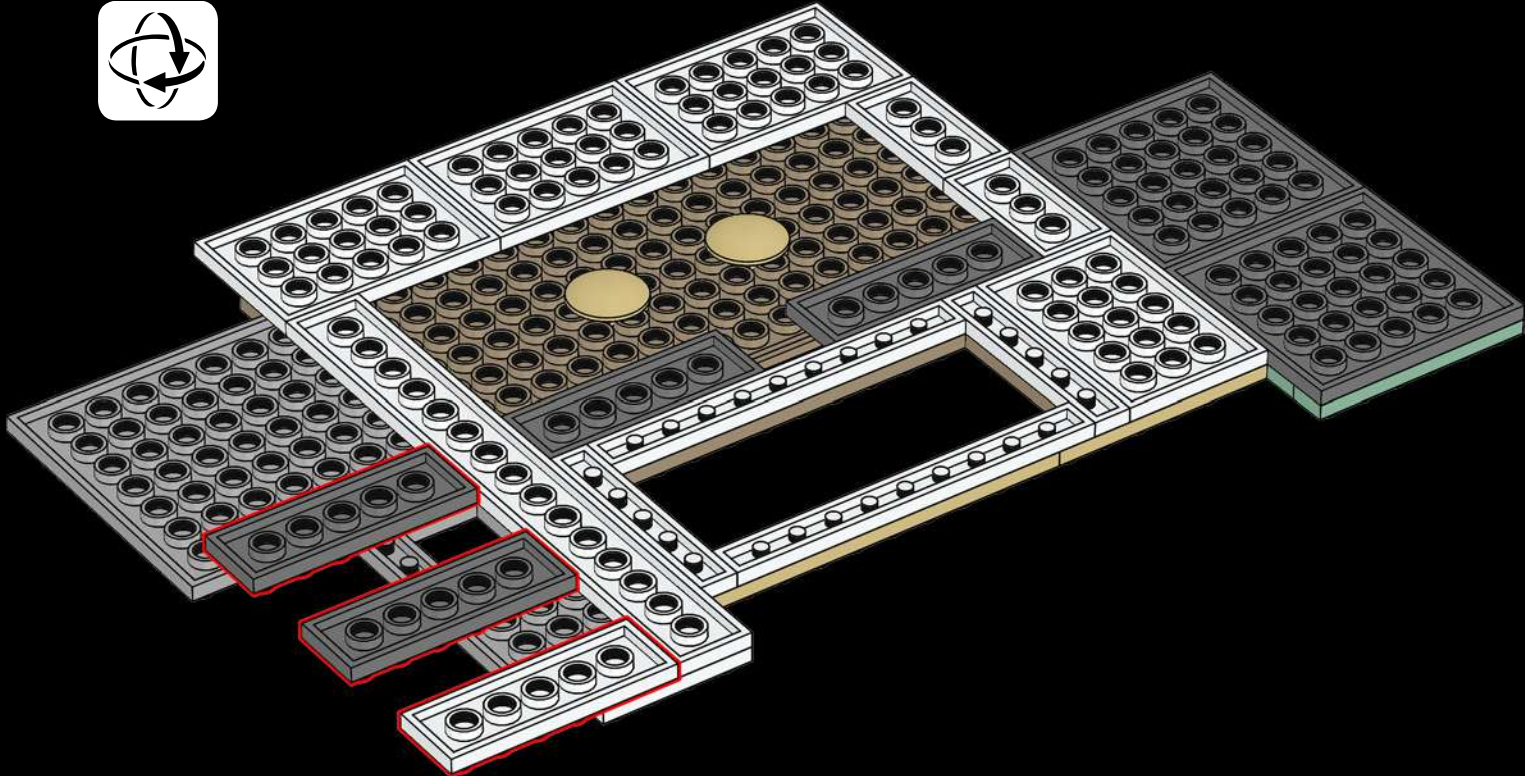

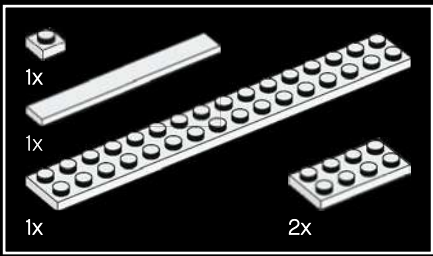

172

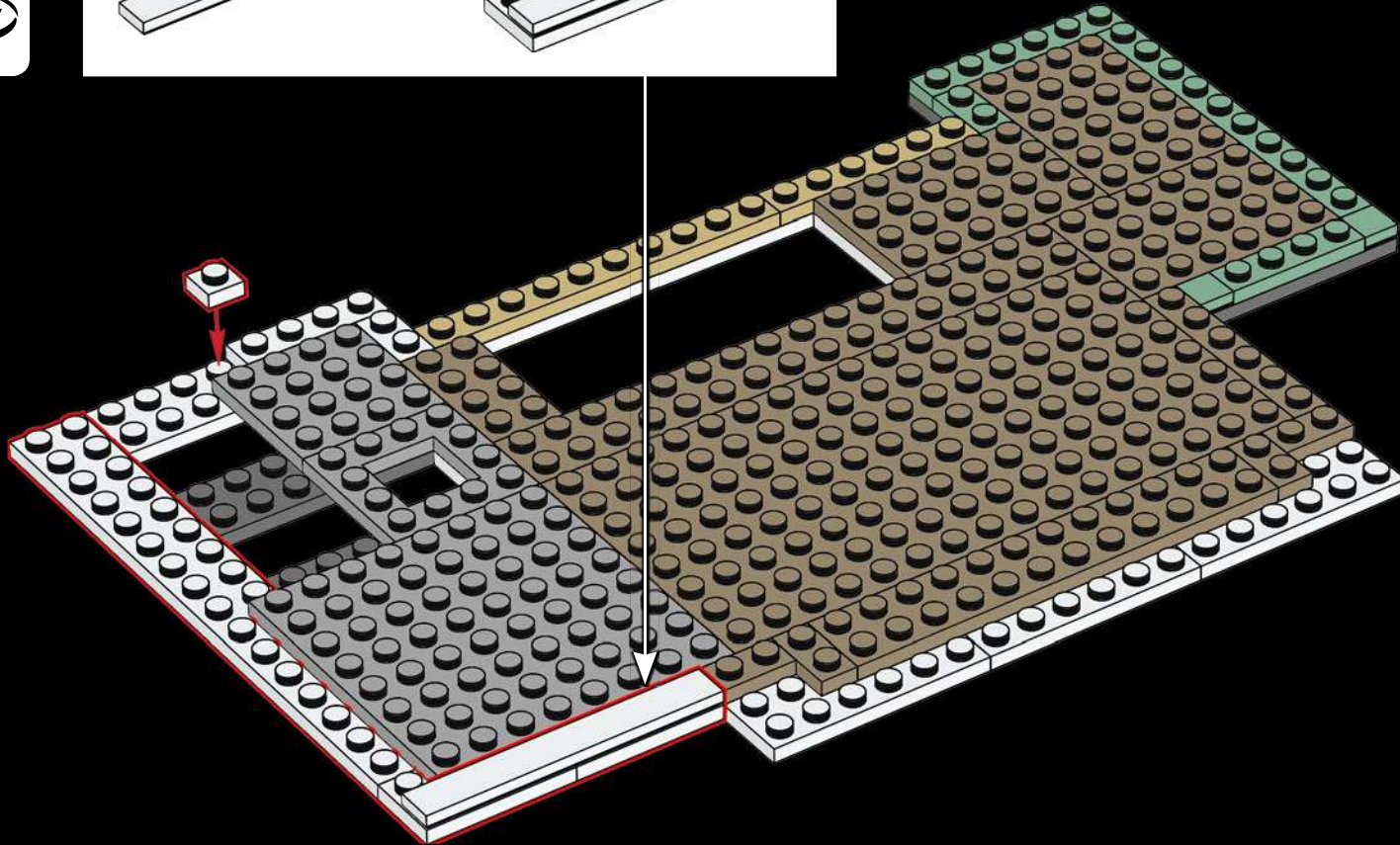
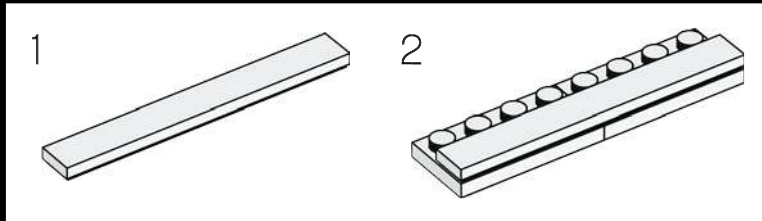

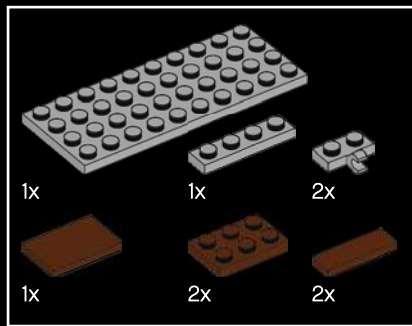

173

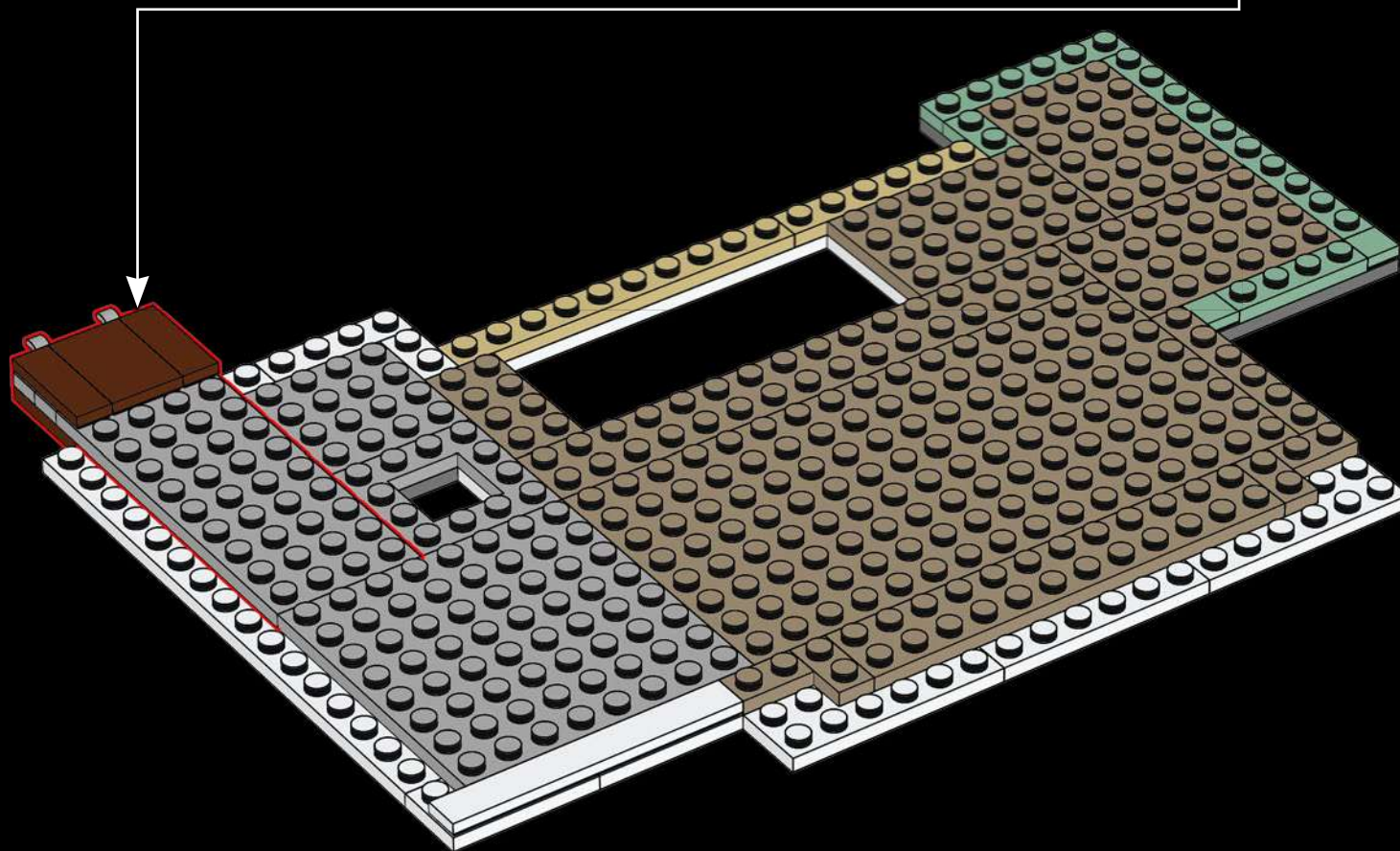
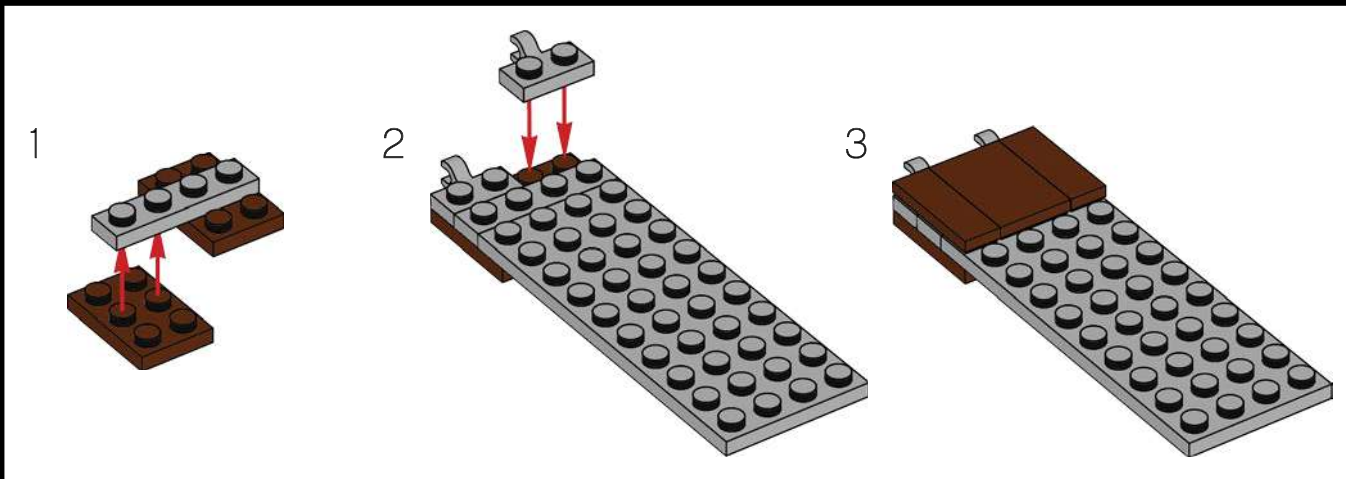

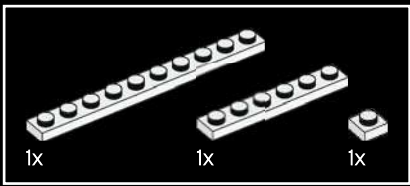

174

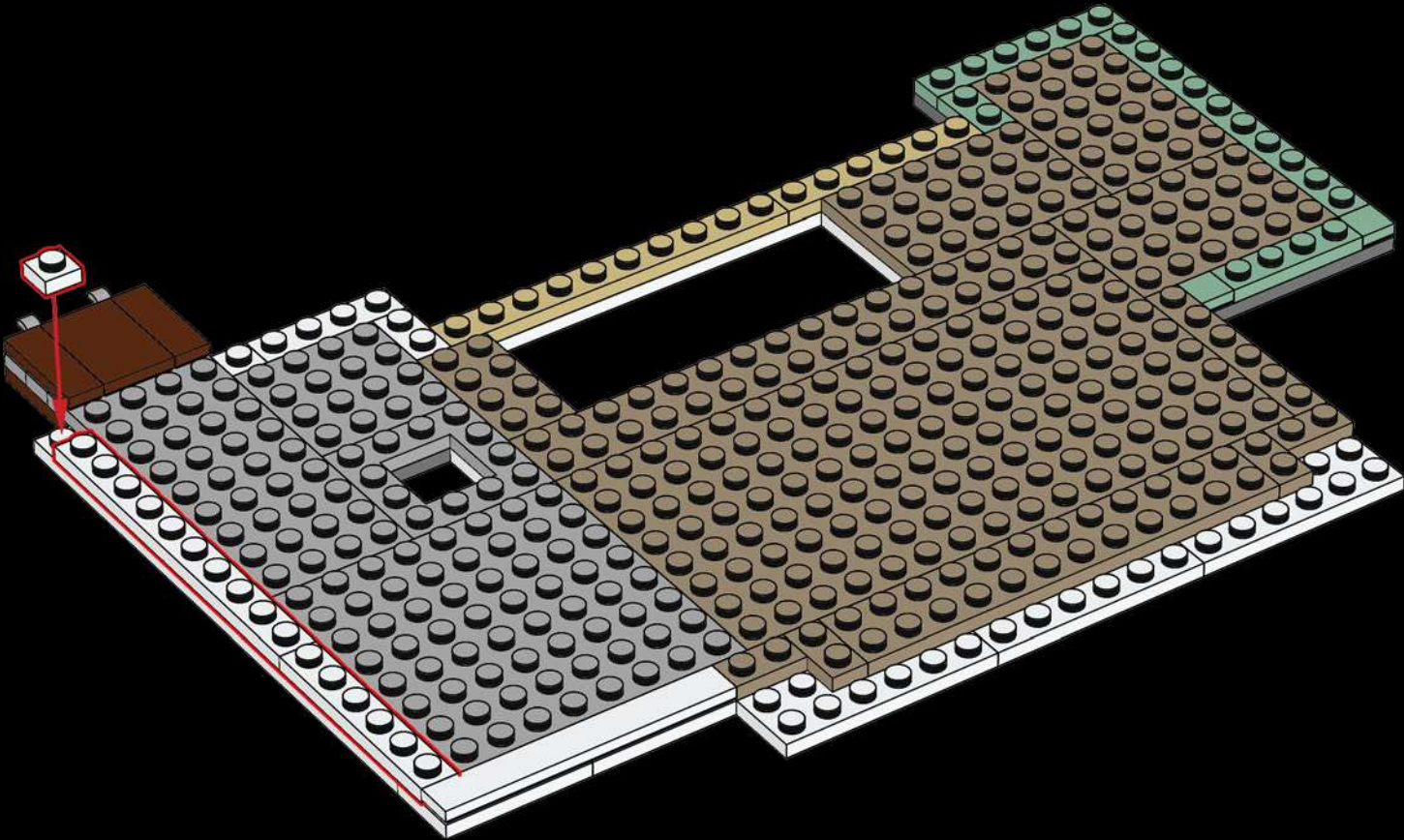

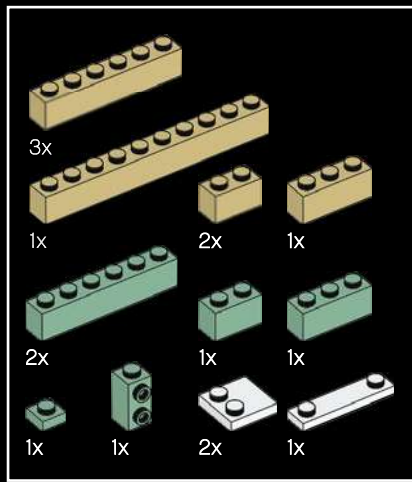

175

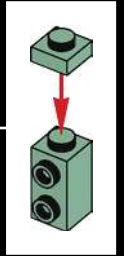
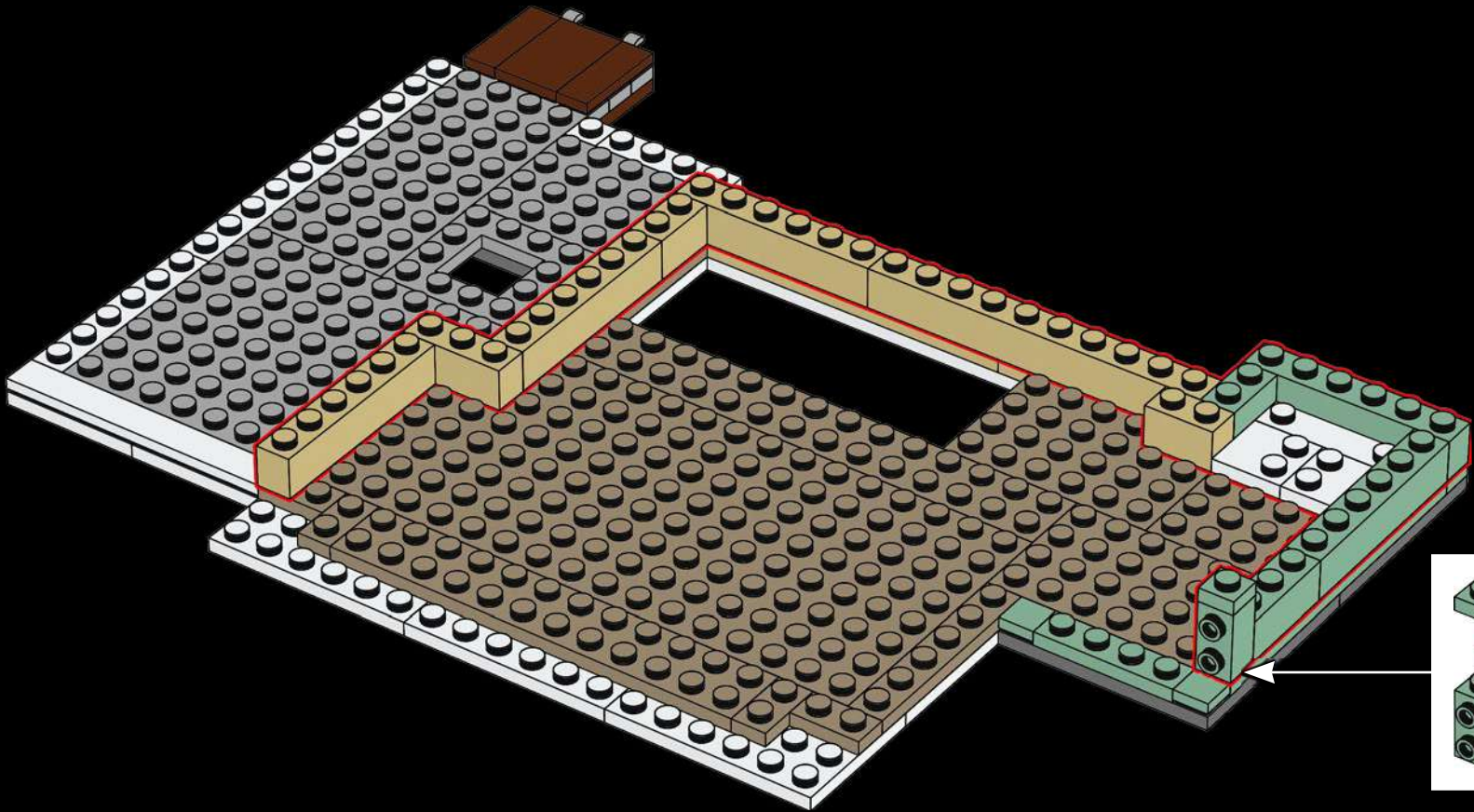

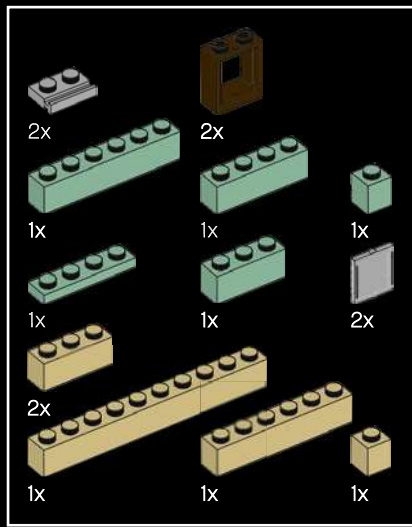

177

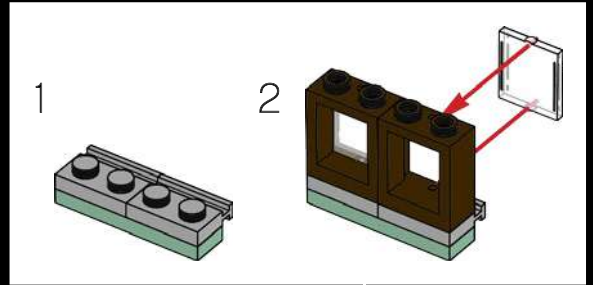
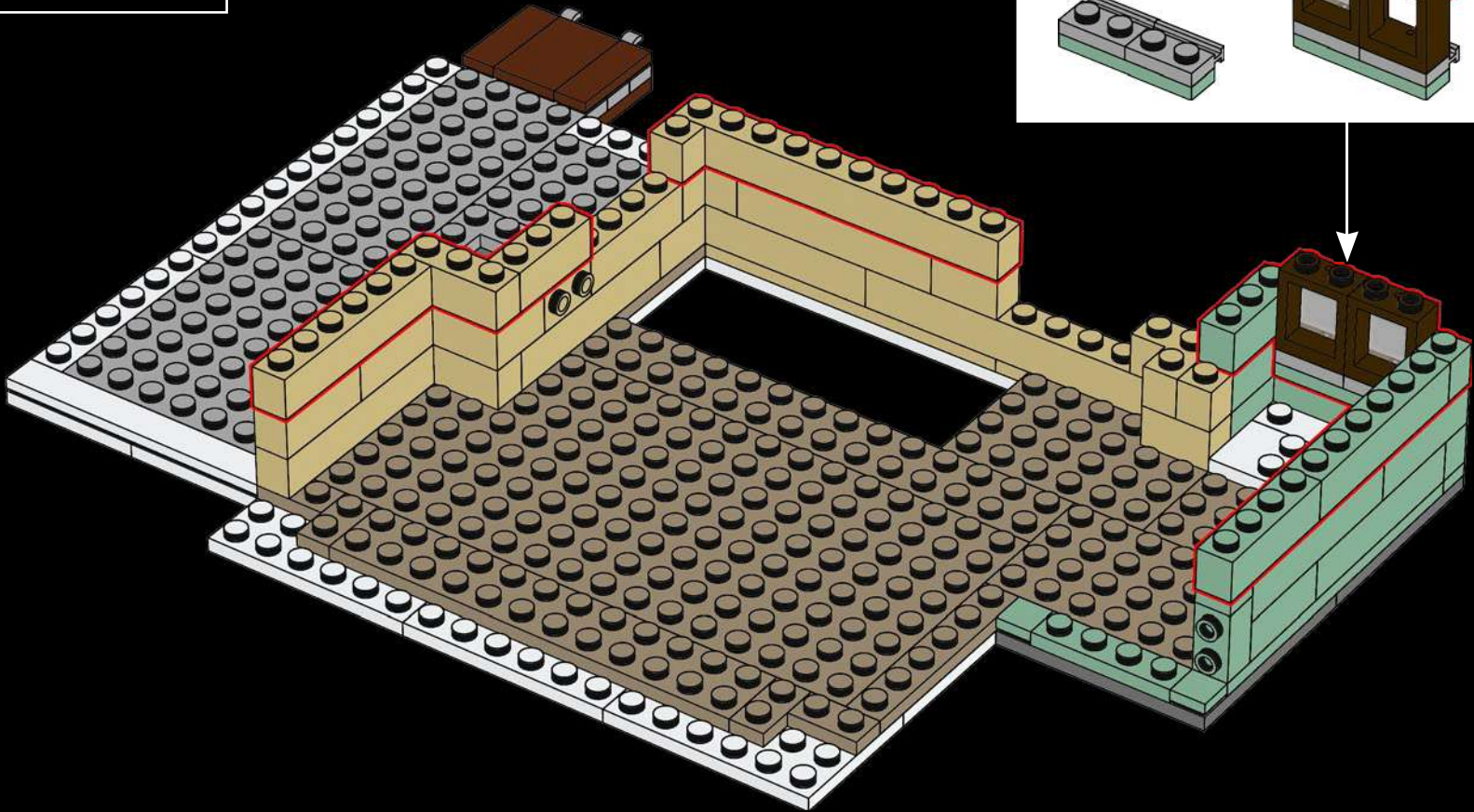

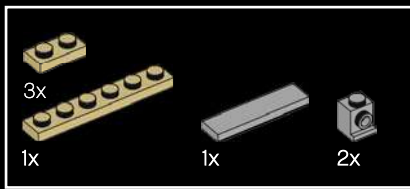

179

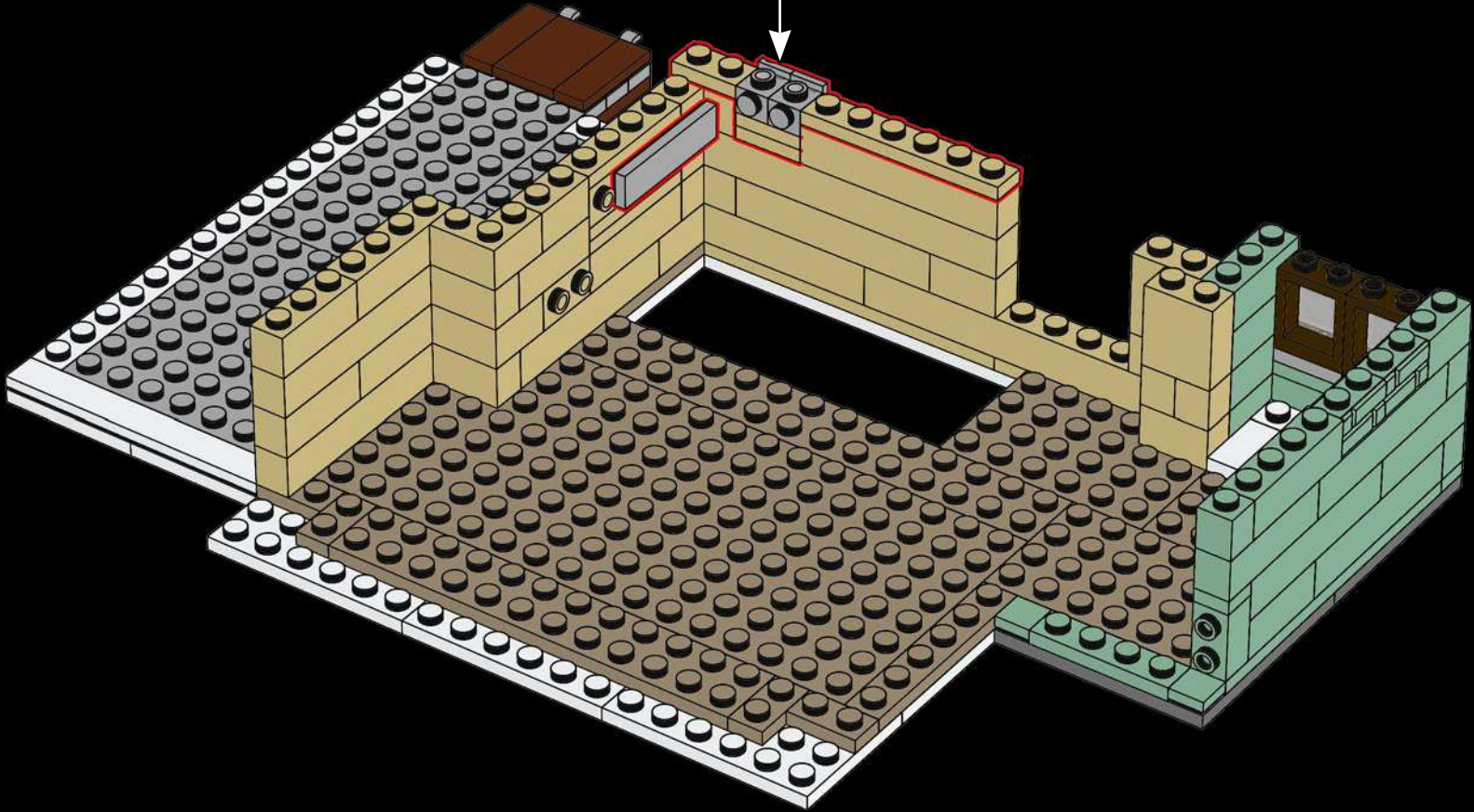
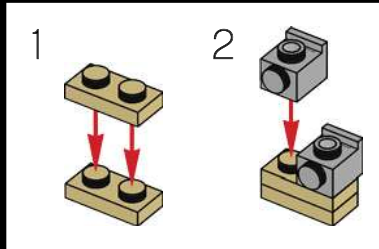

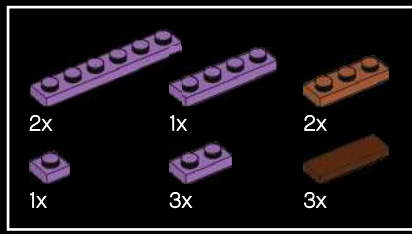

181

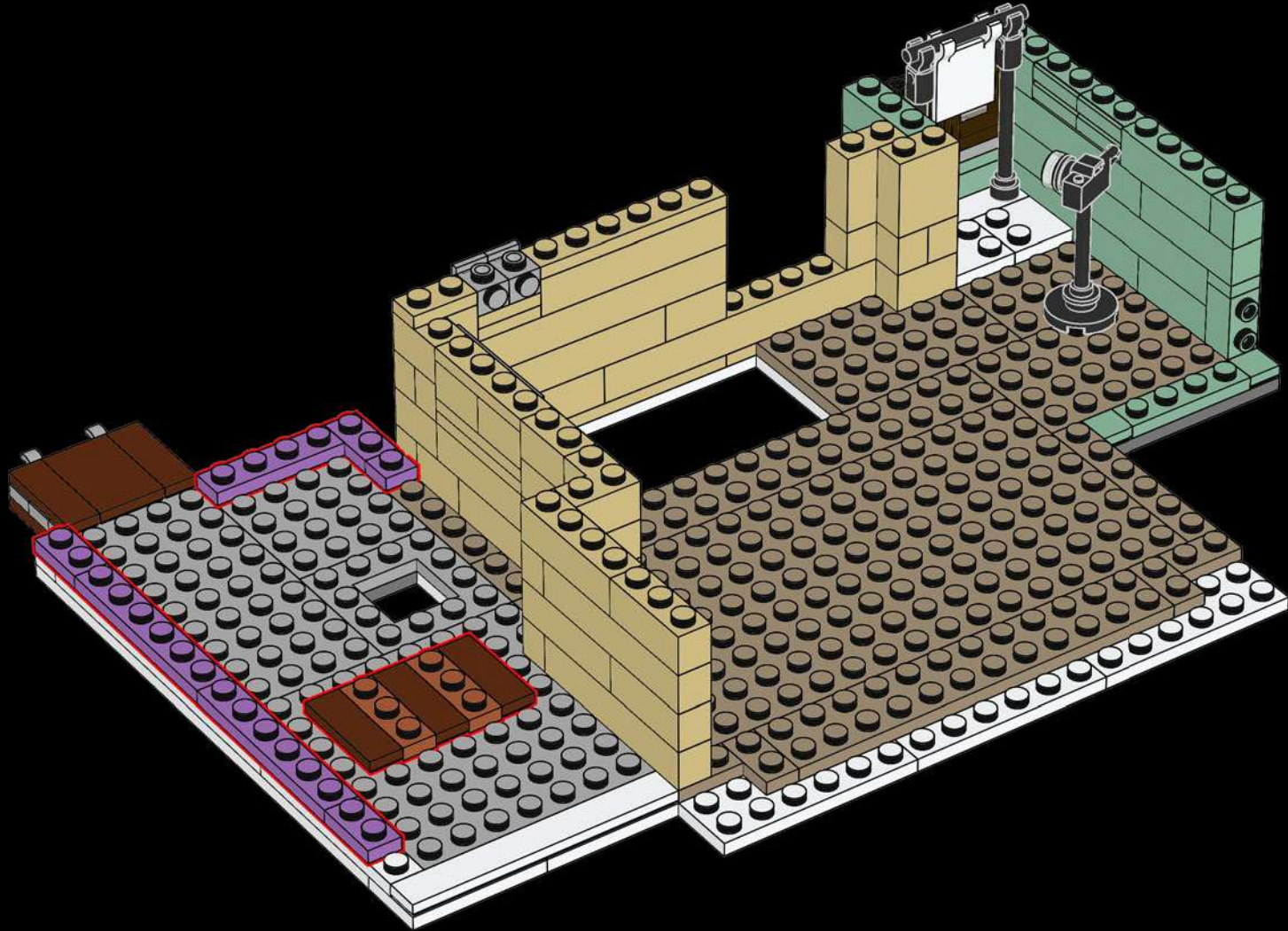

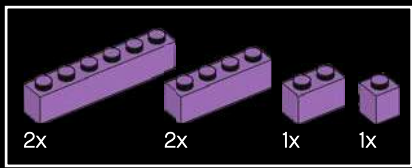

182

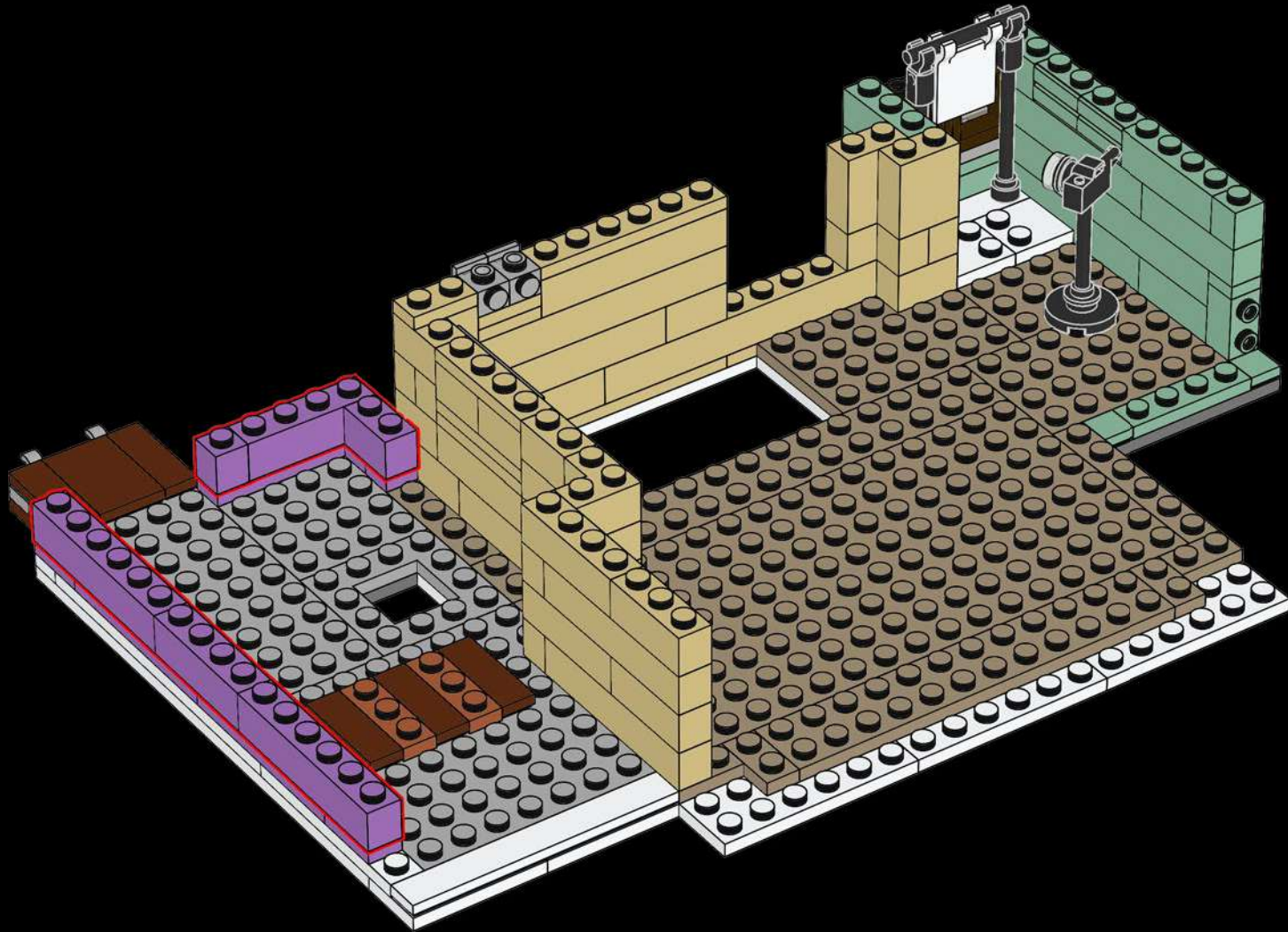

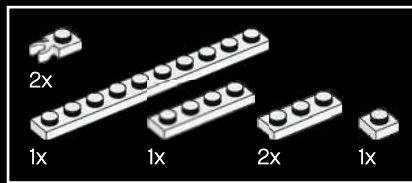

183

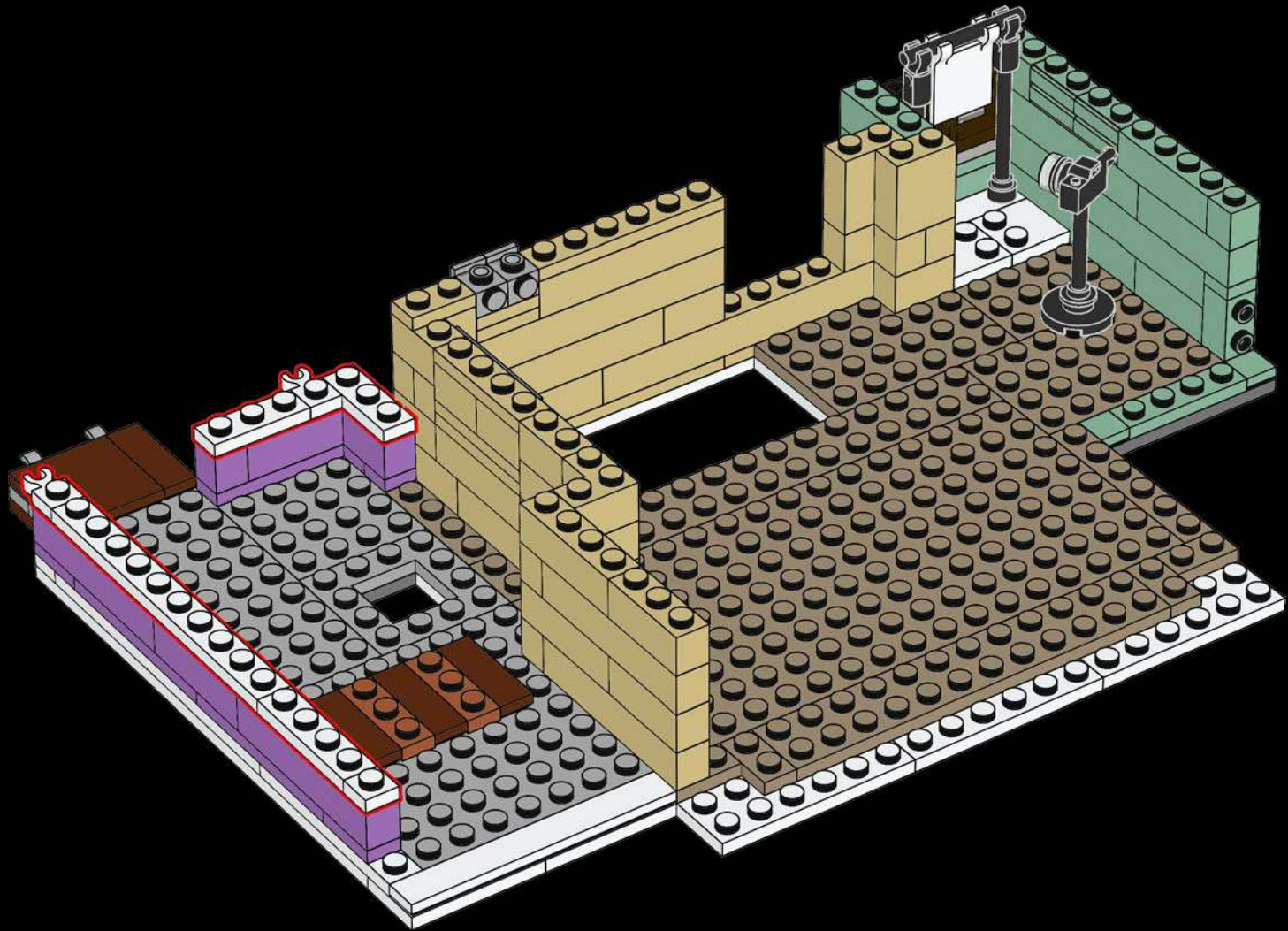

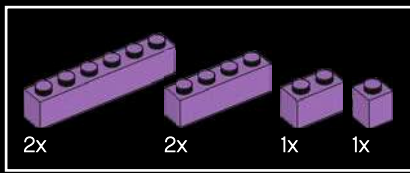

184

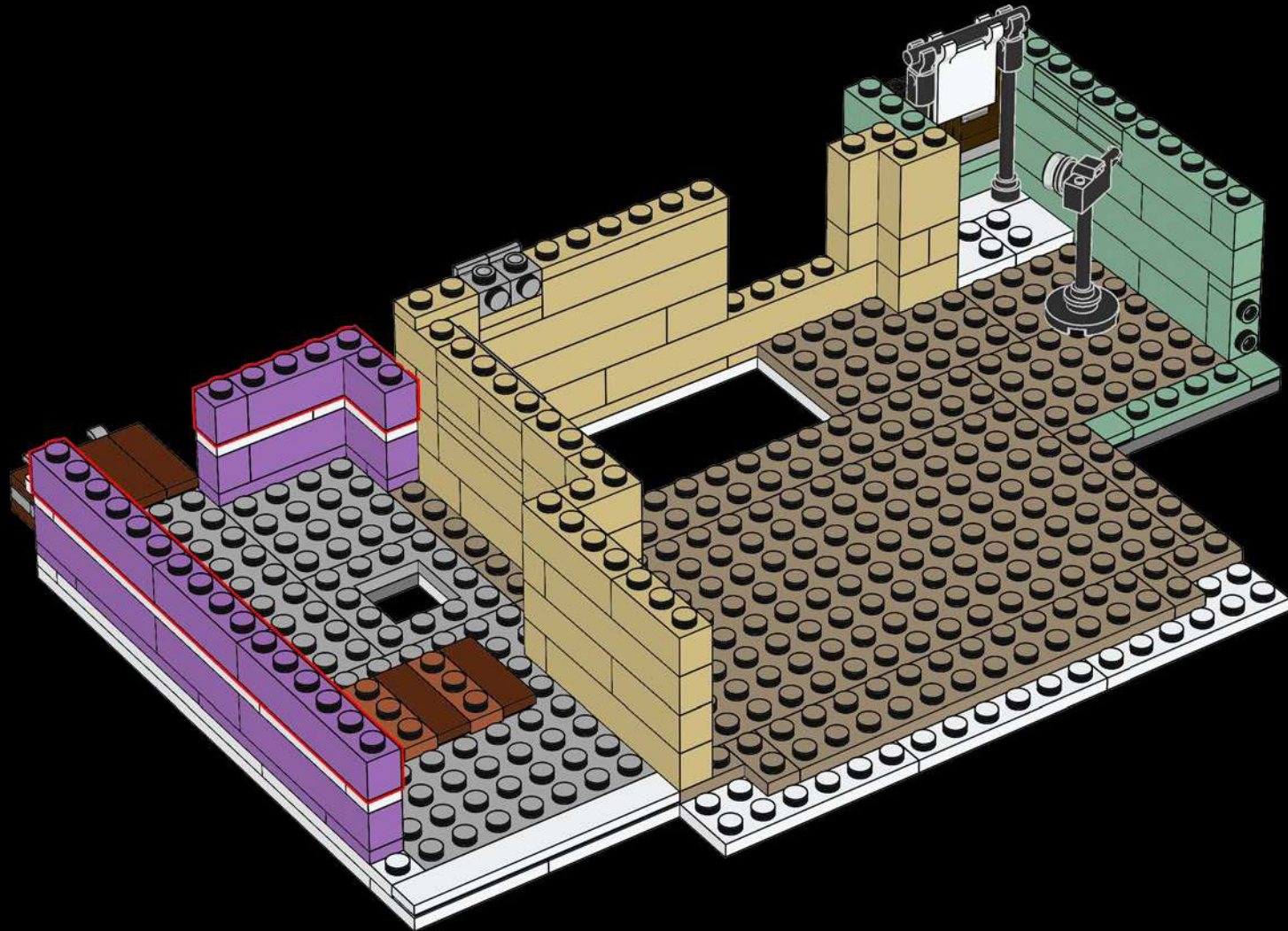

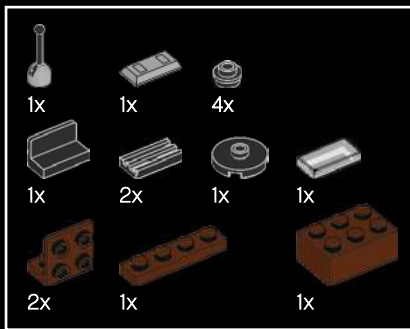

185

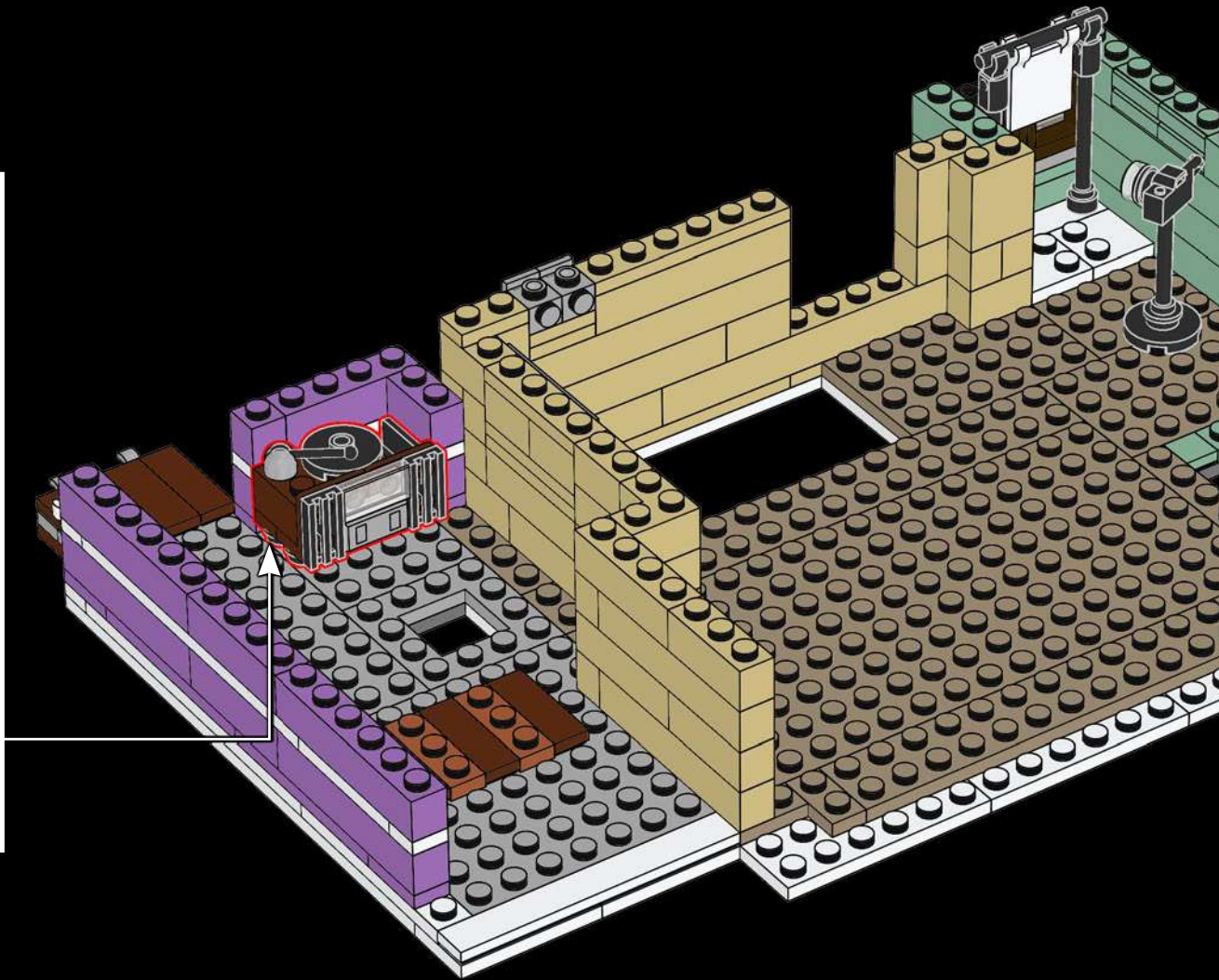
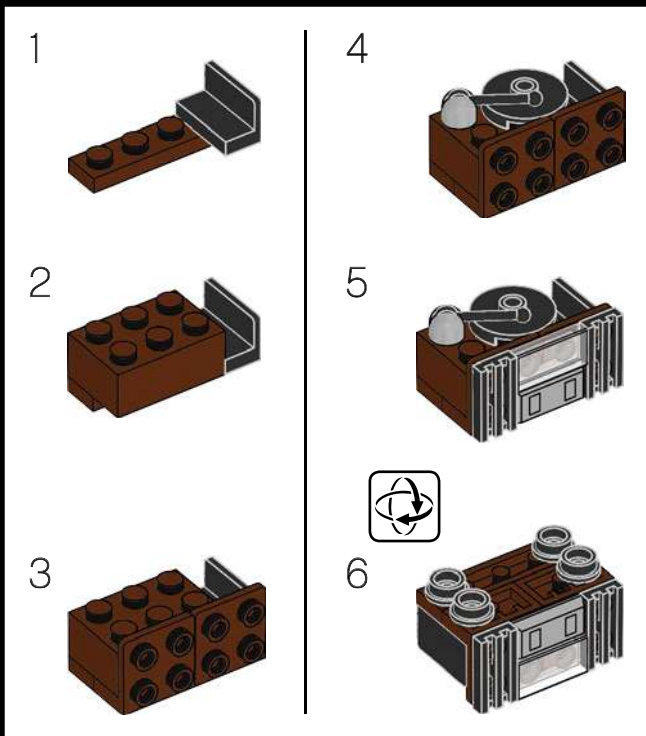

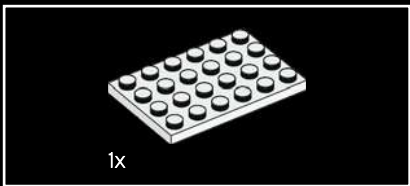

186

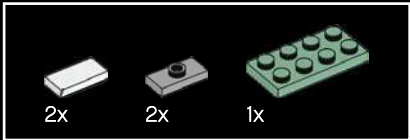
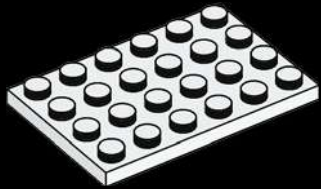

187

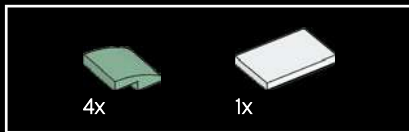
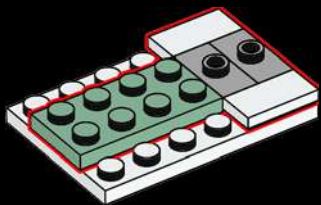

188

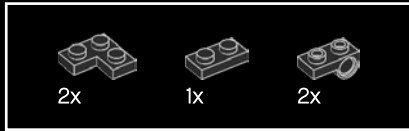
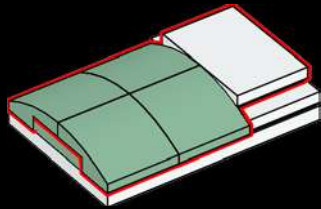

189

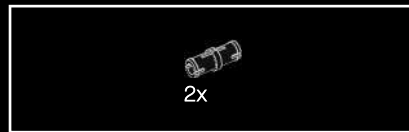
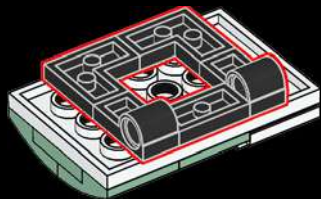

190

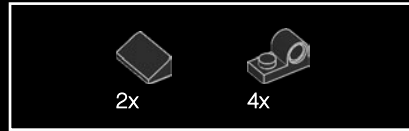
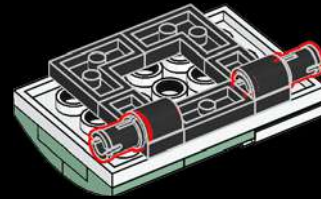

191

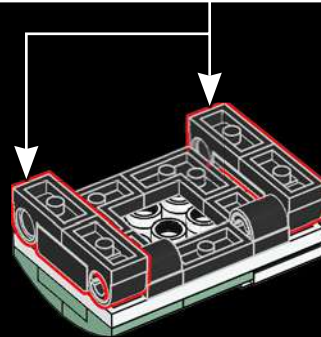
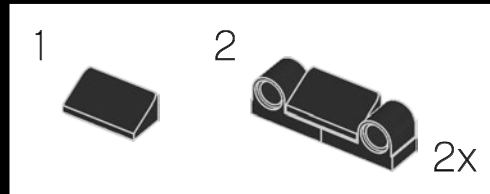

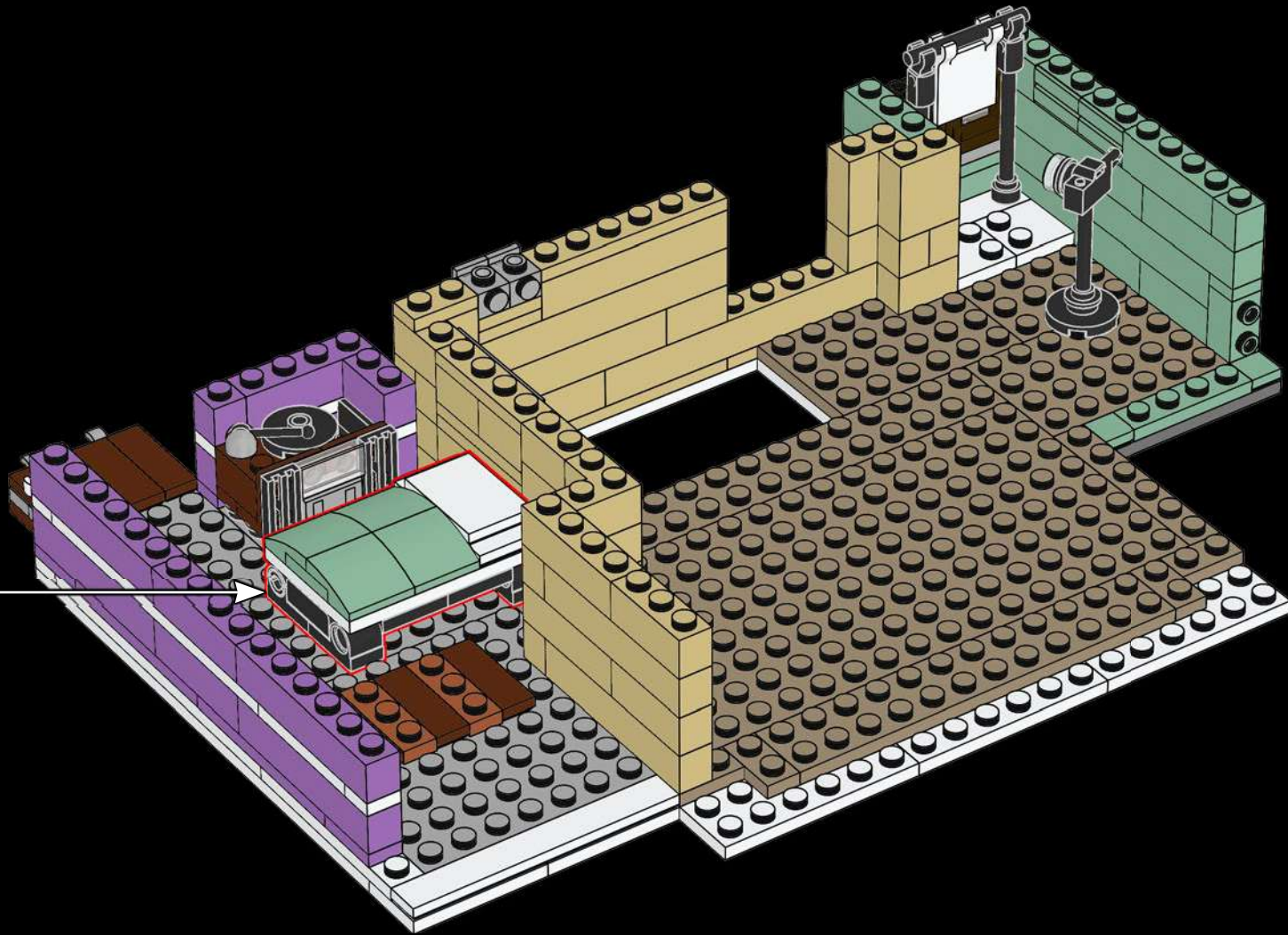

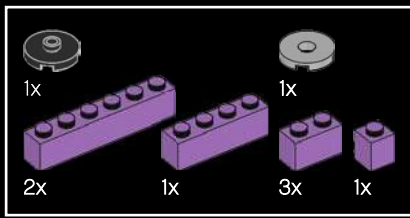

193

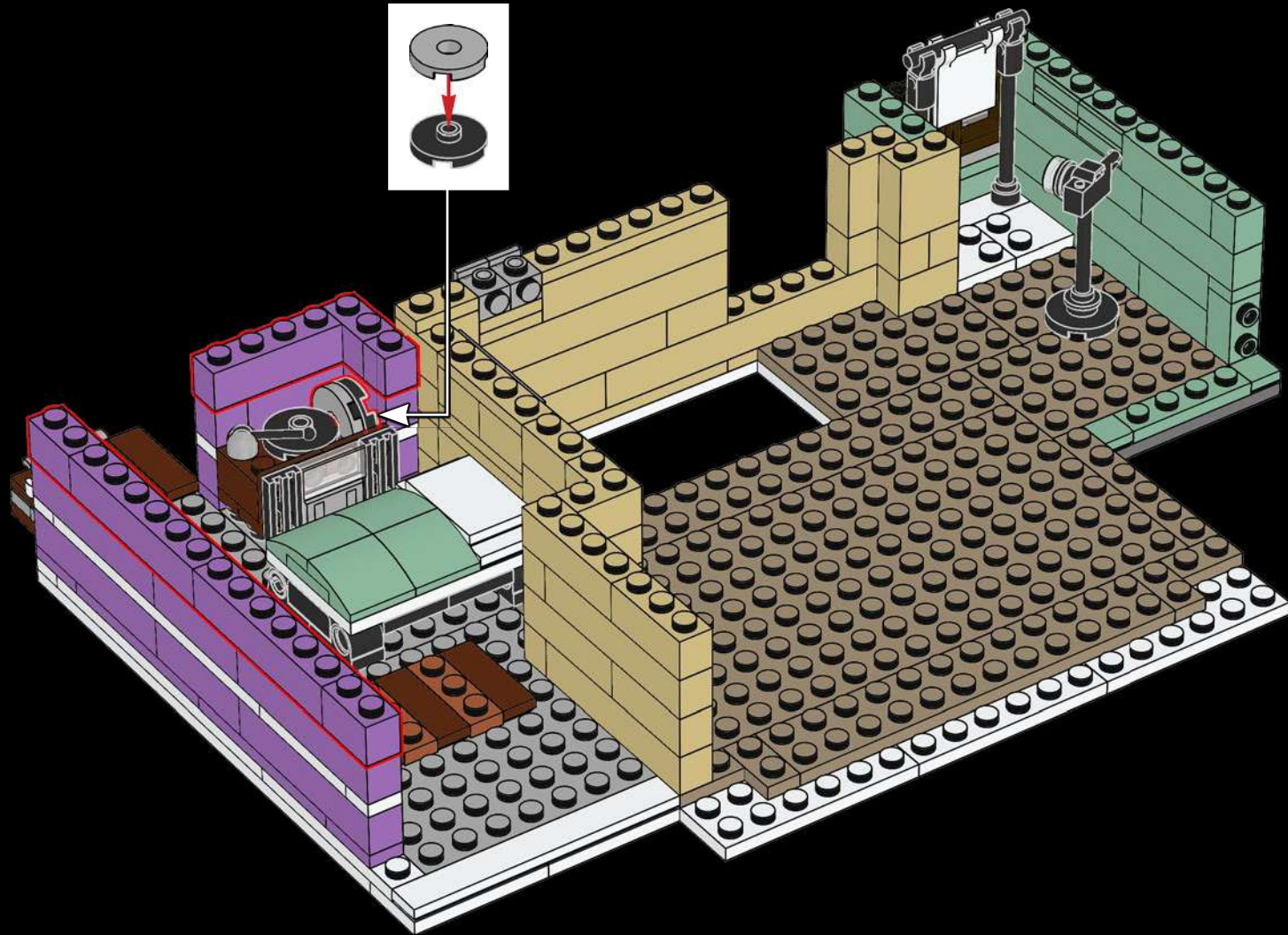

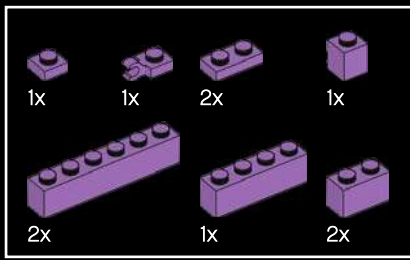

194

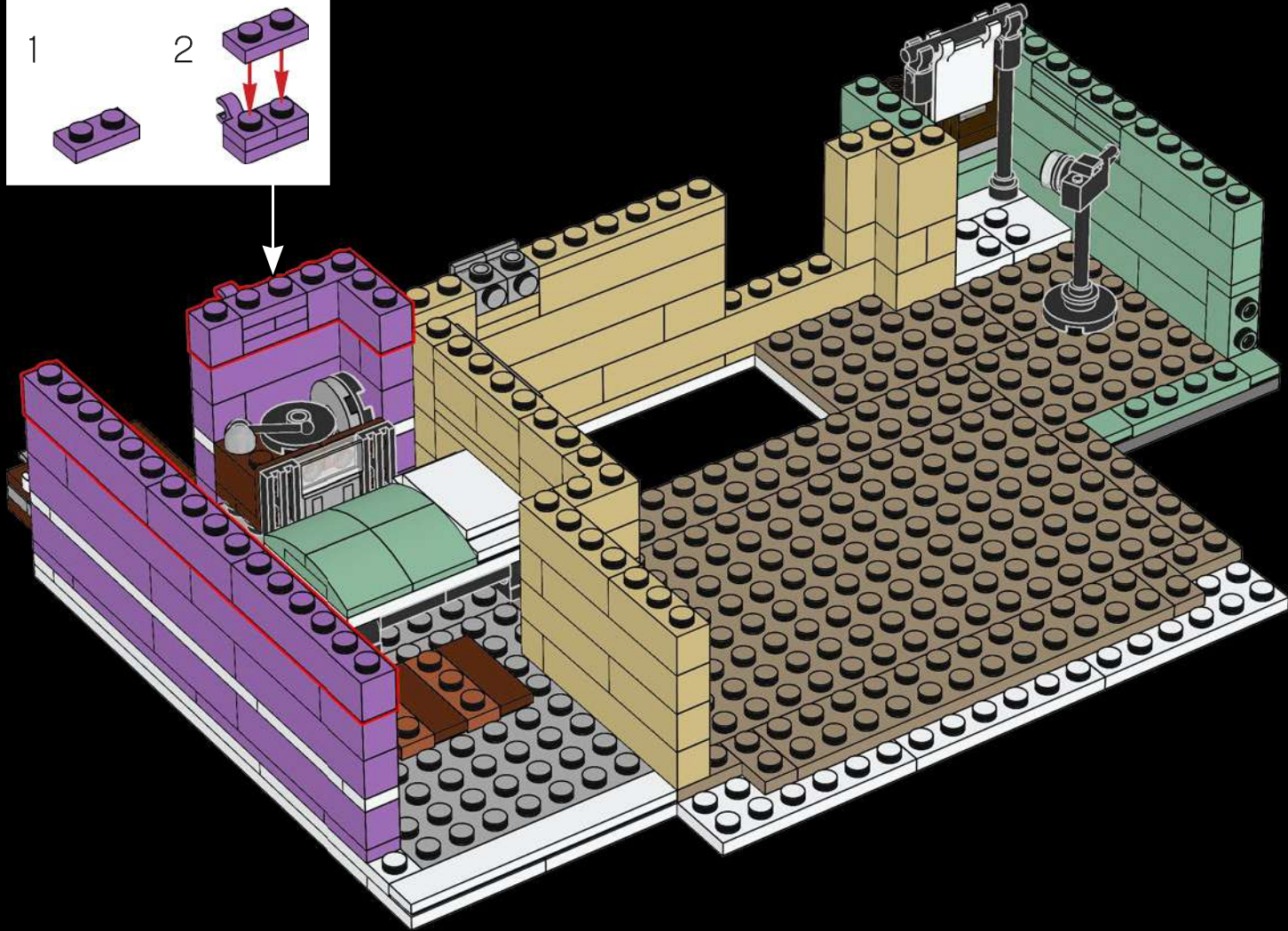
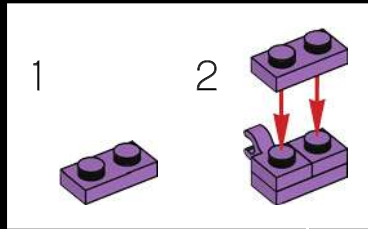

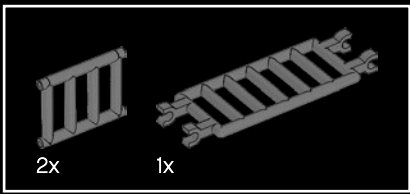

195

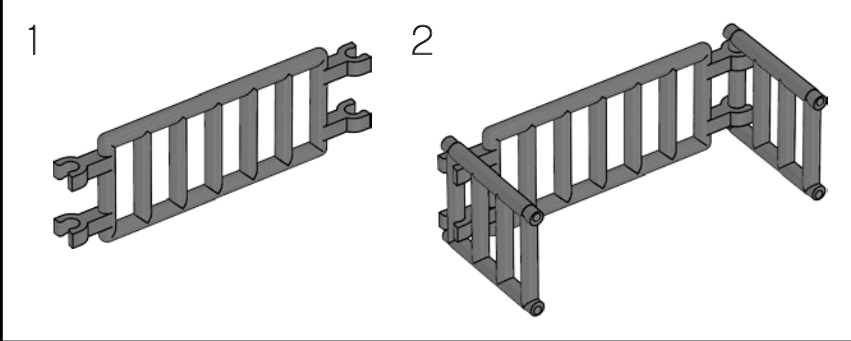
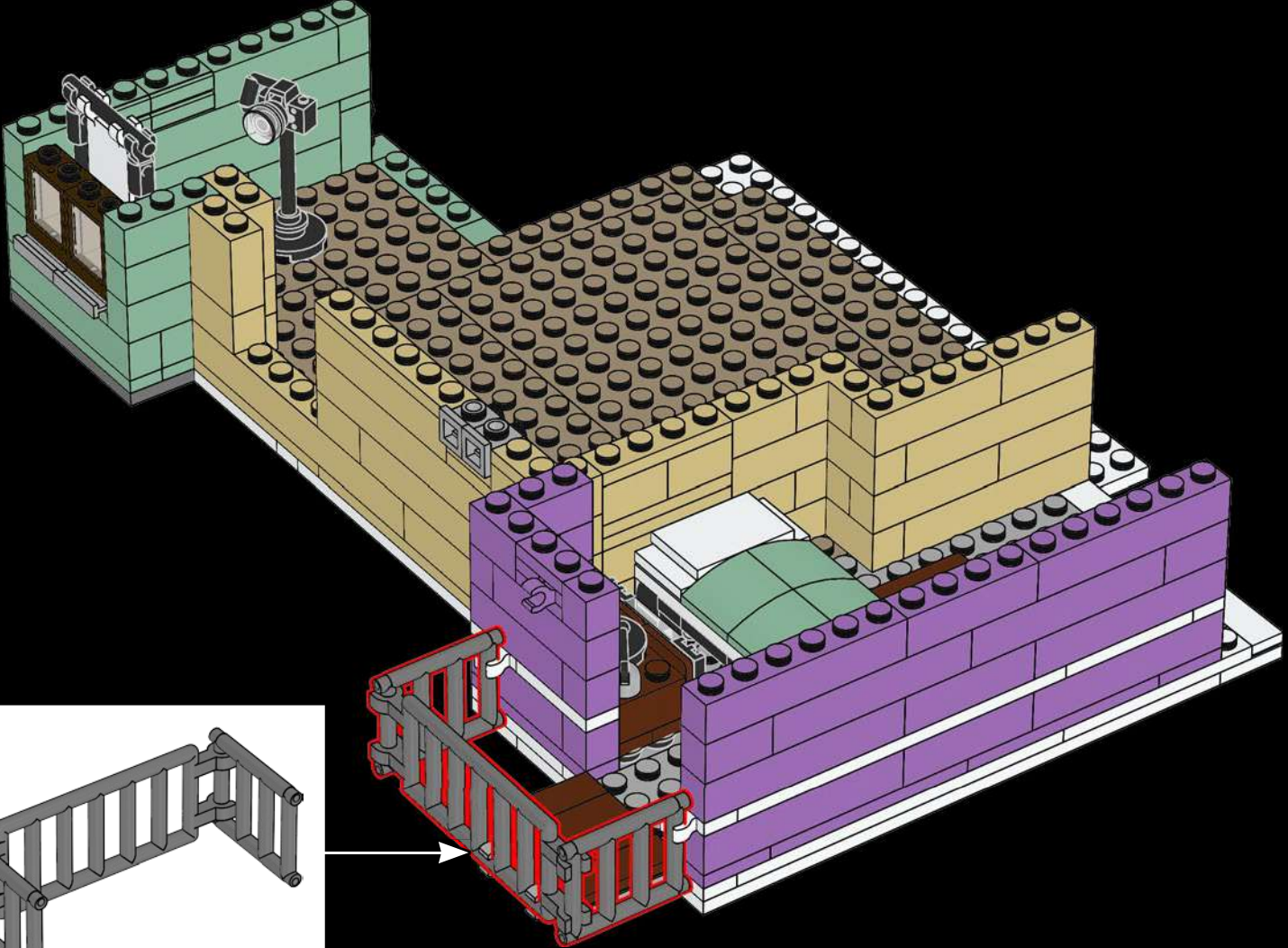

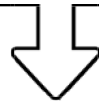

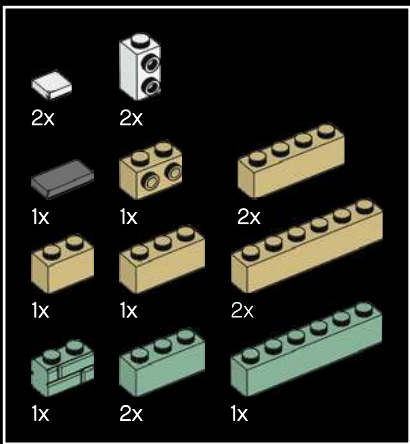

196

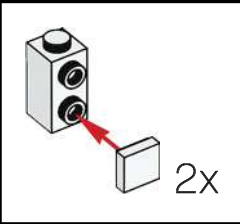
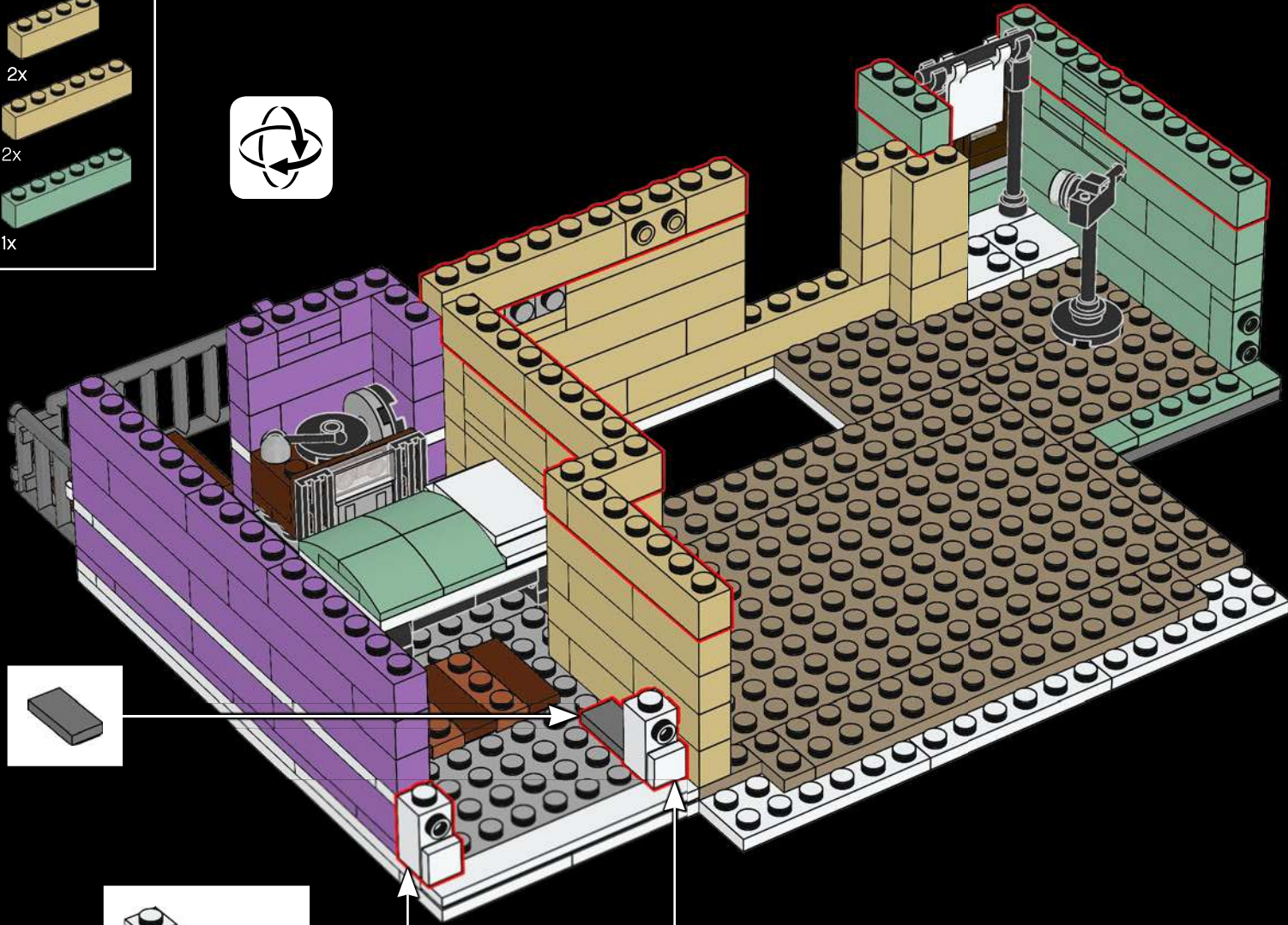

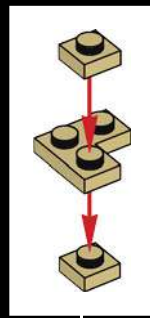
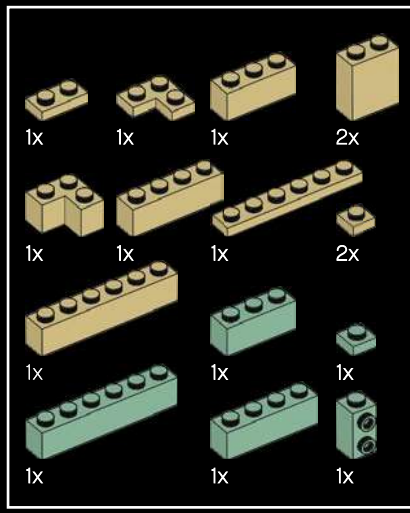

197

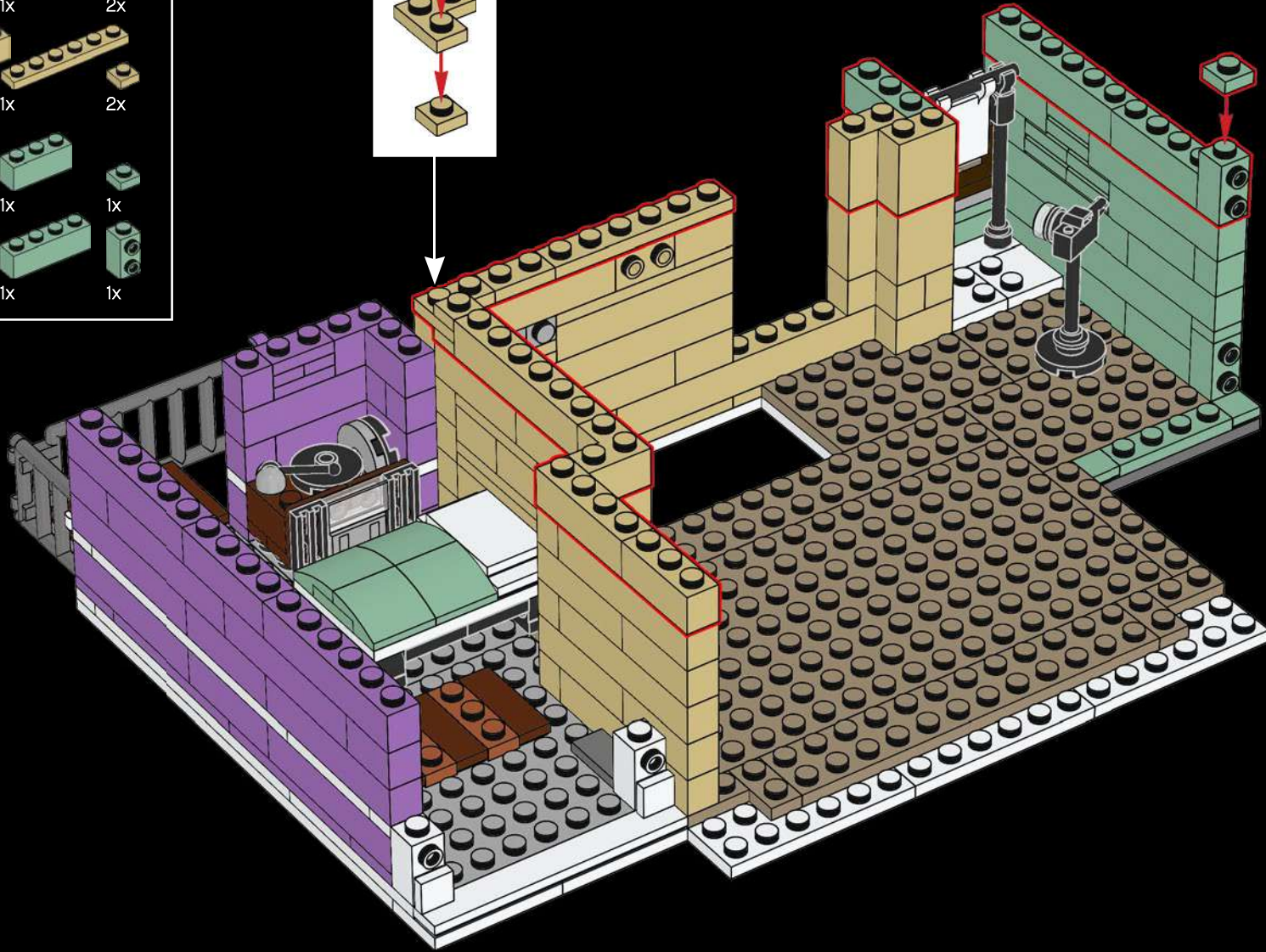

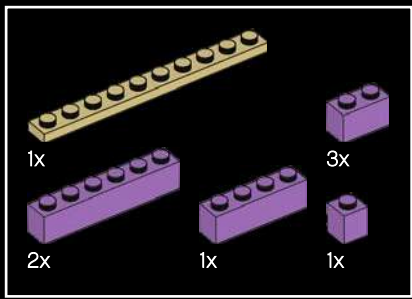

198

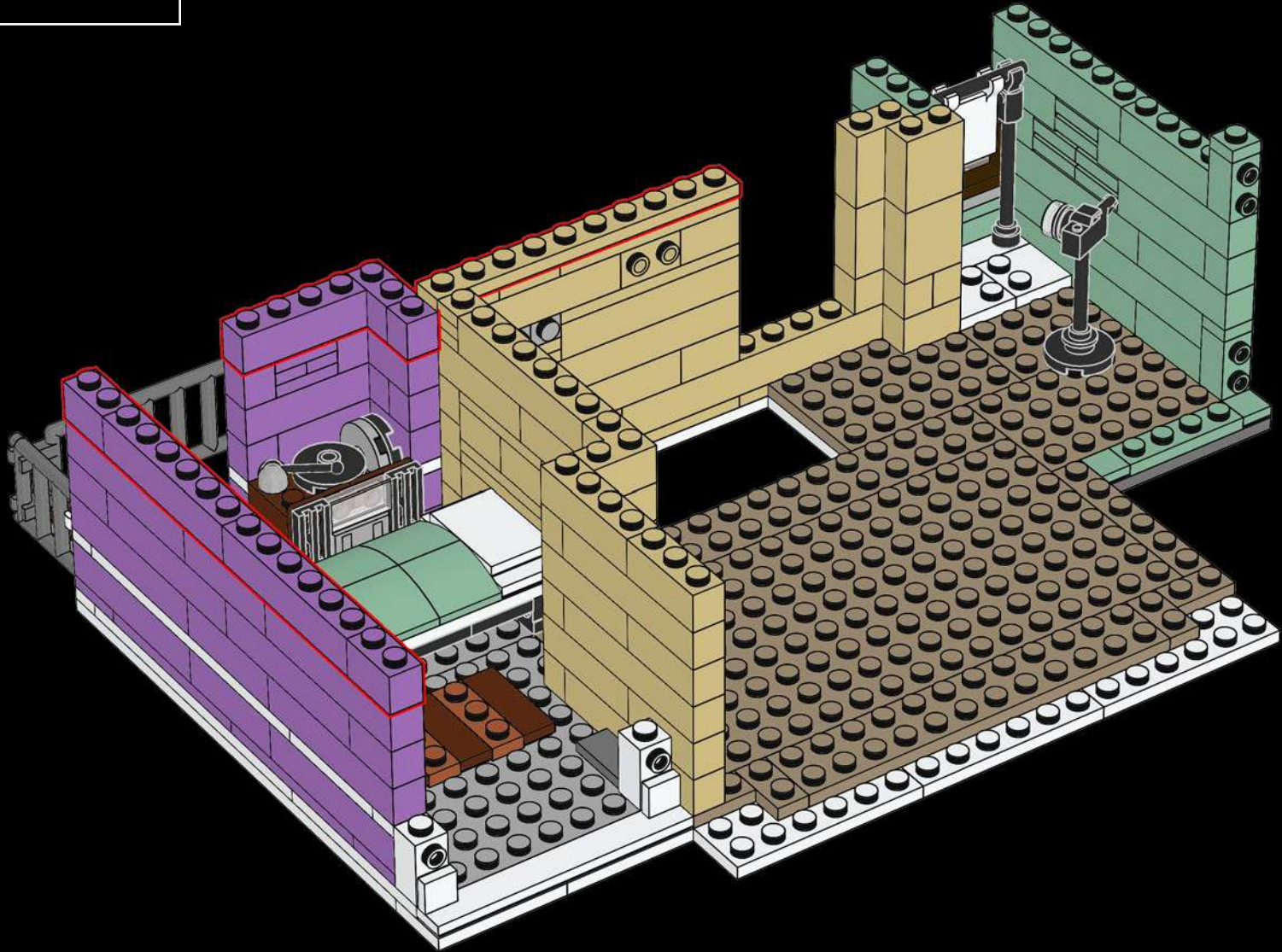

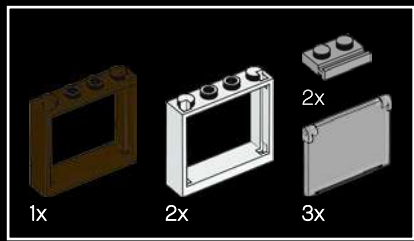

200

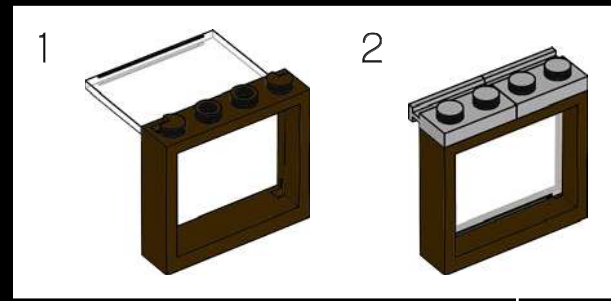
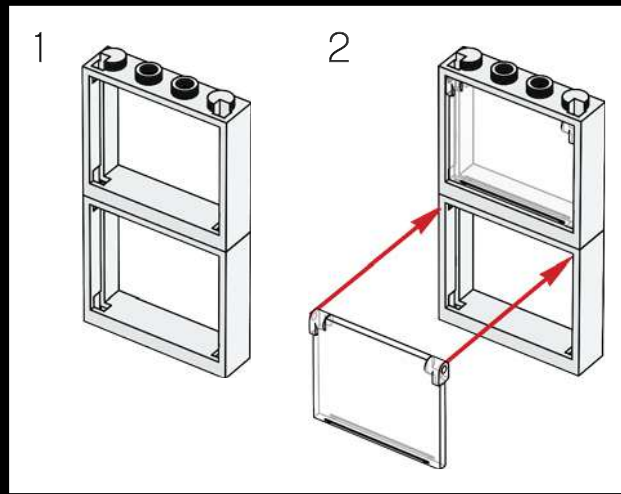

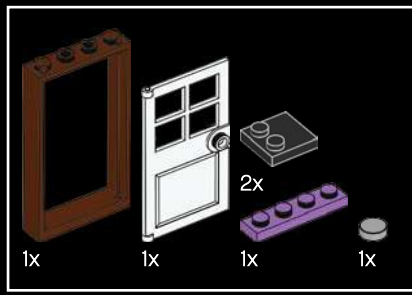

201

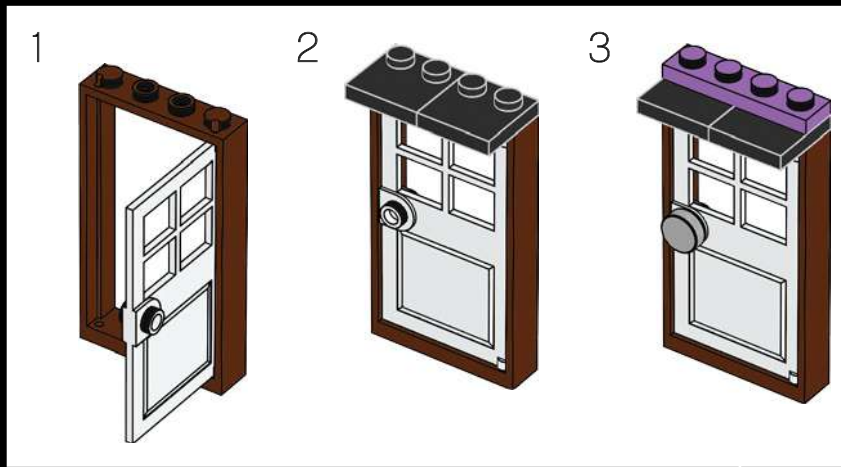

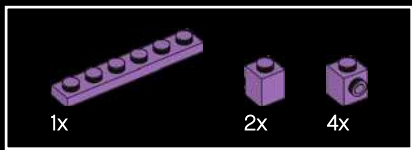

202

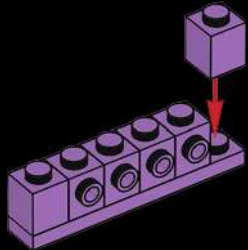

203

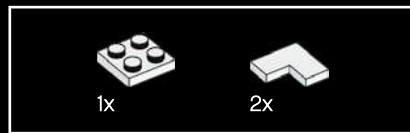
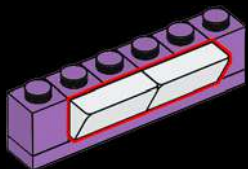

204

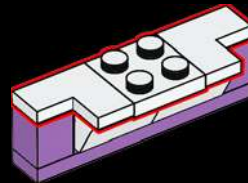

205

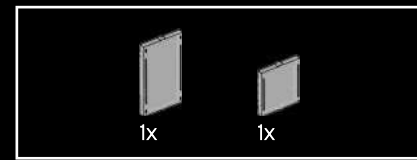
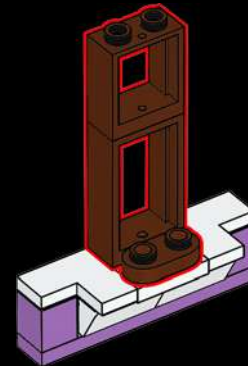

206

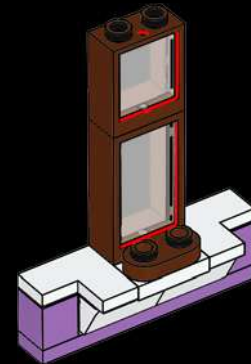

207





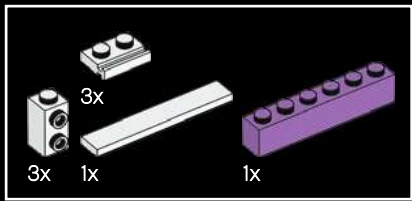

209

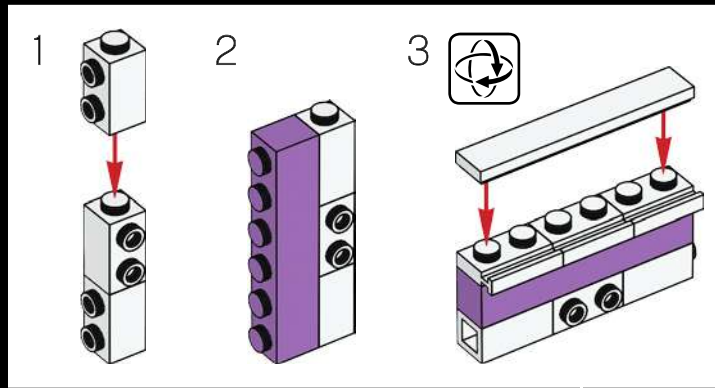

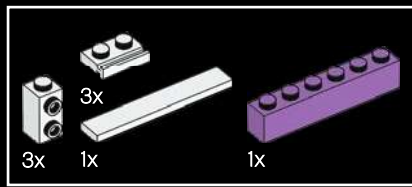

210

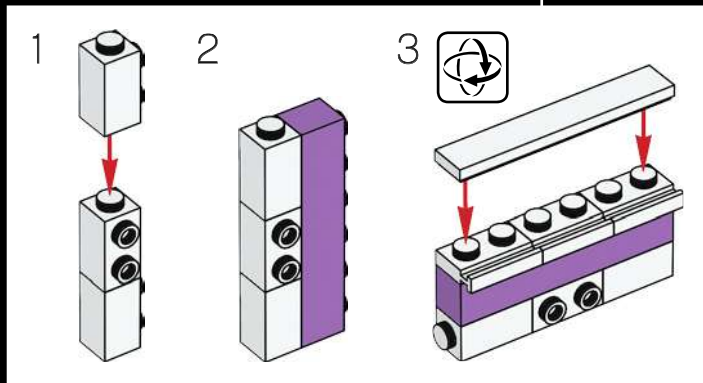

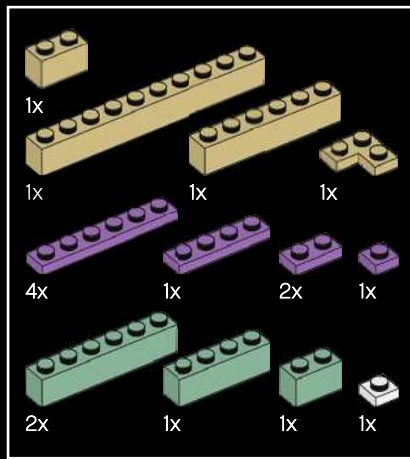

212



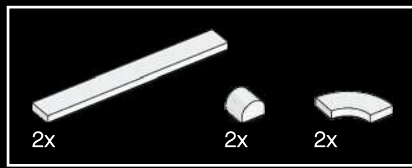

214

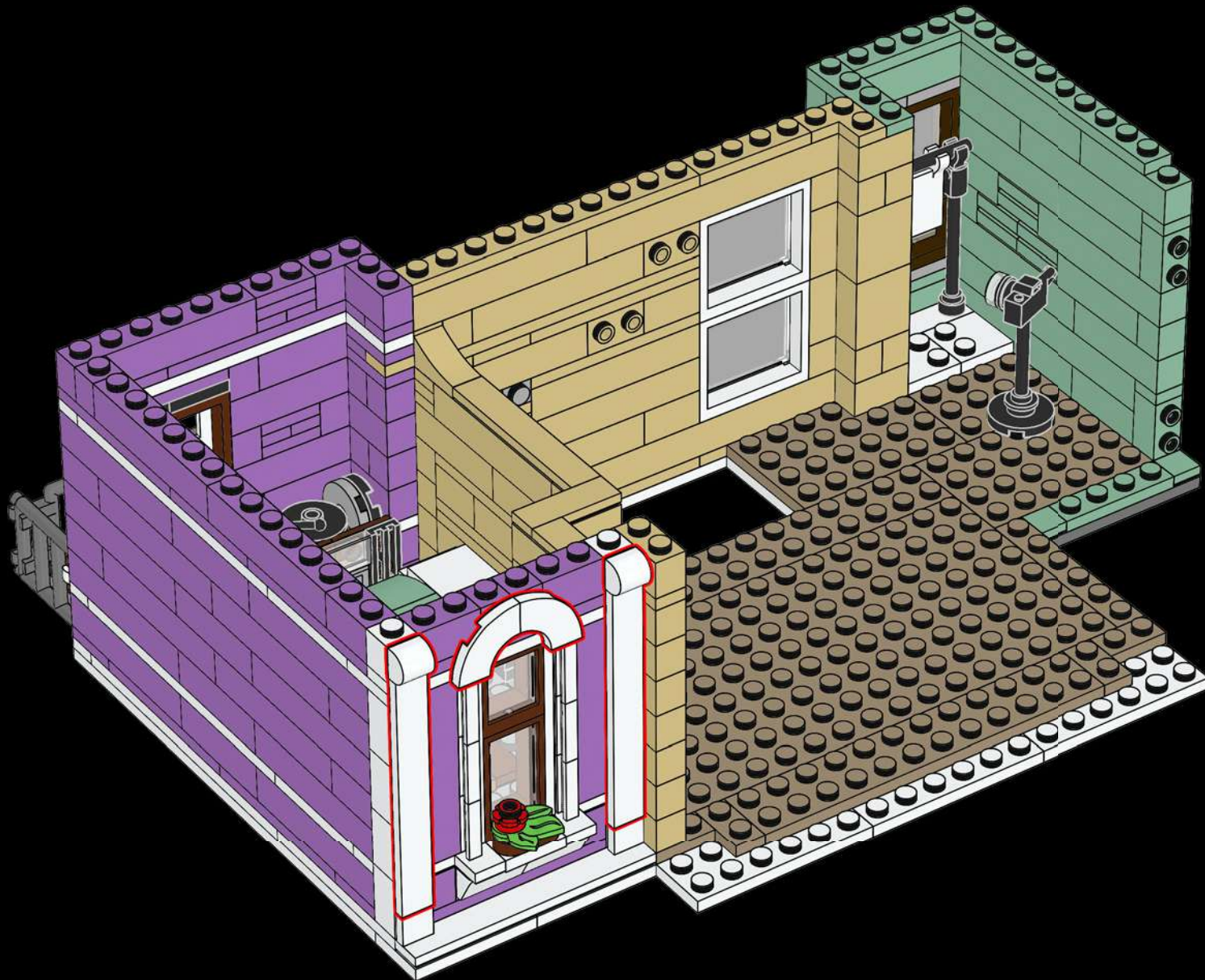

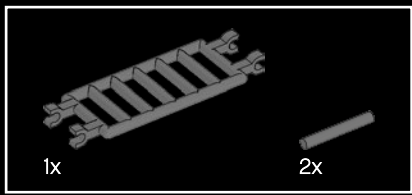

215

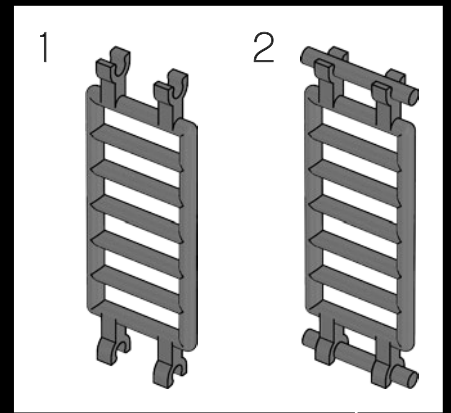

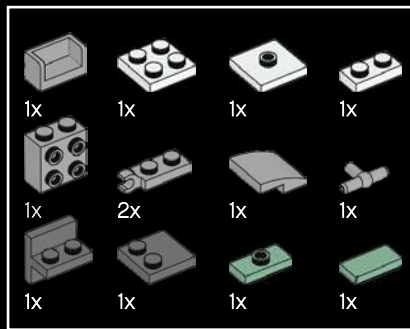

216

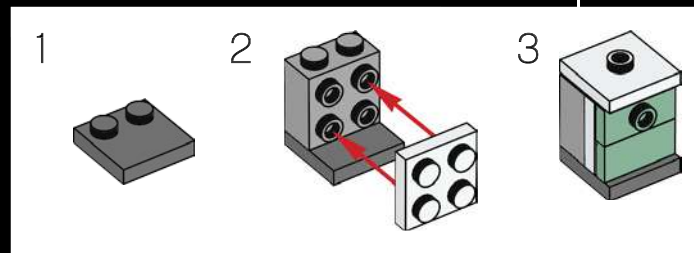
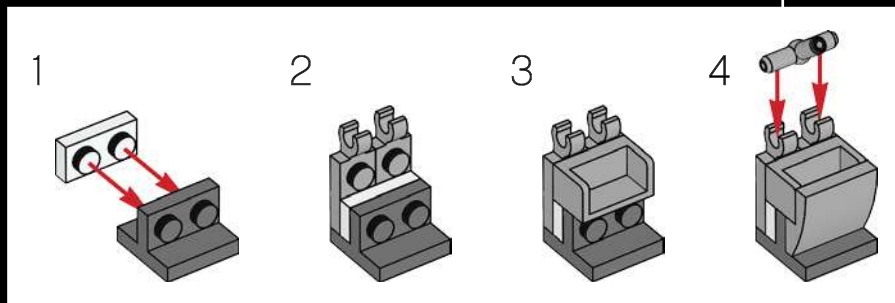
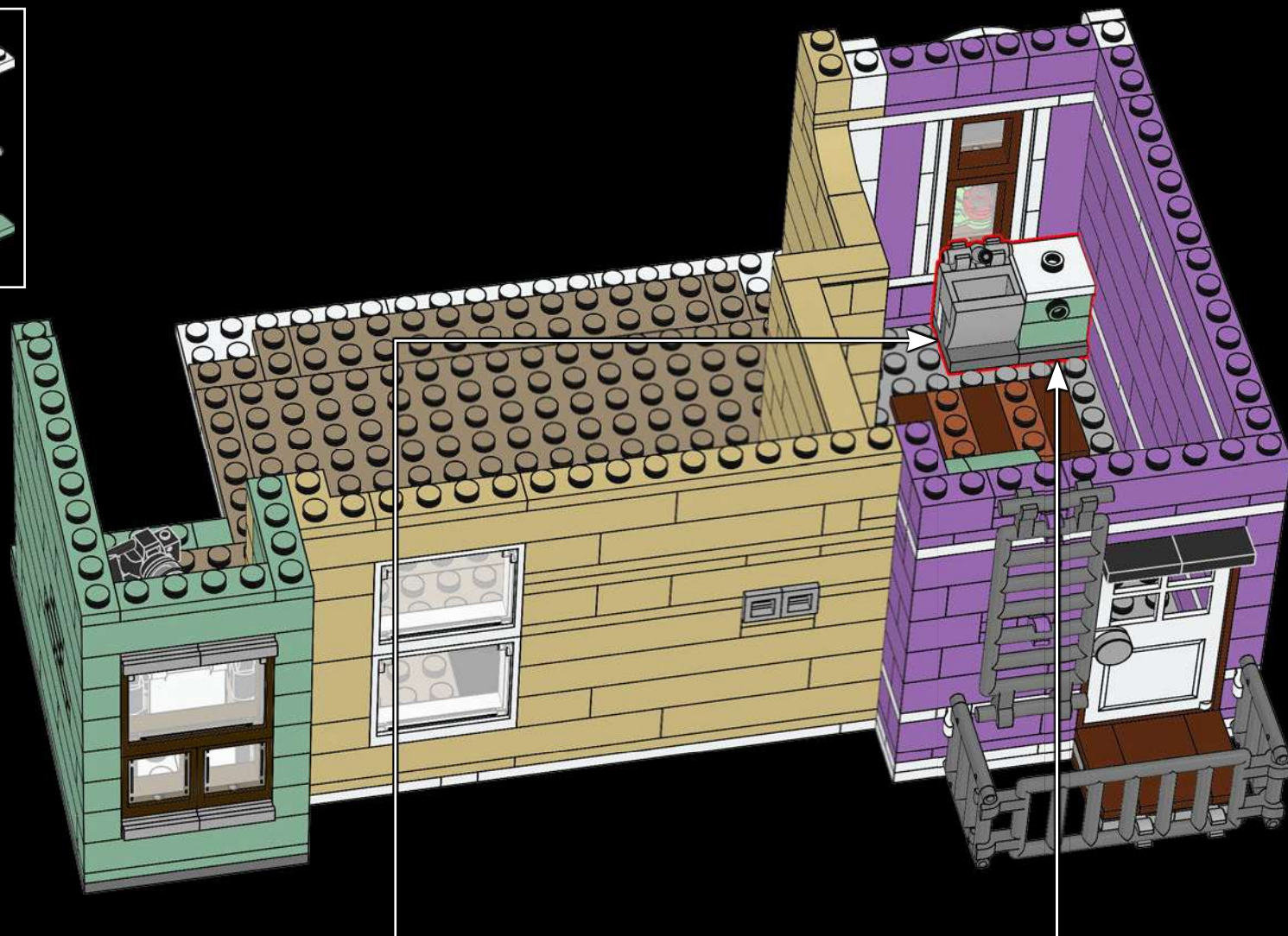

The veteran police officer is ready to solve any crime that comes his way.

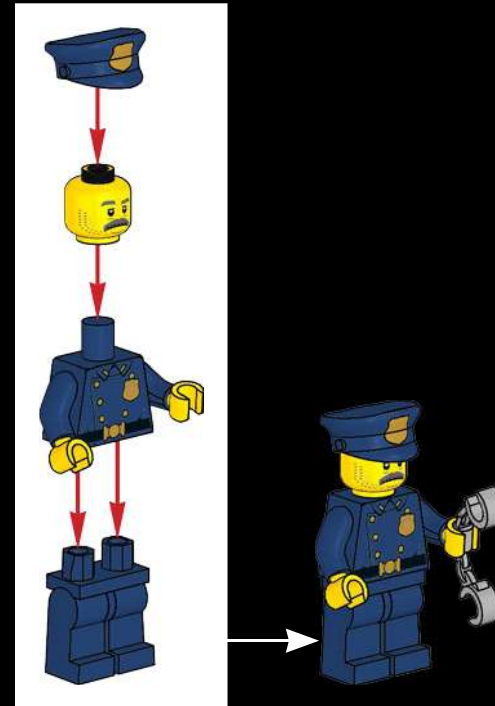
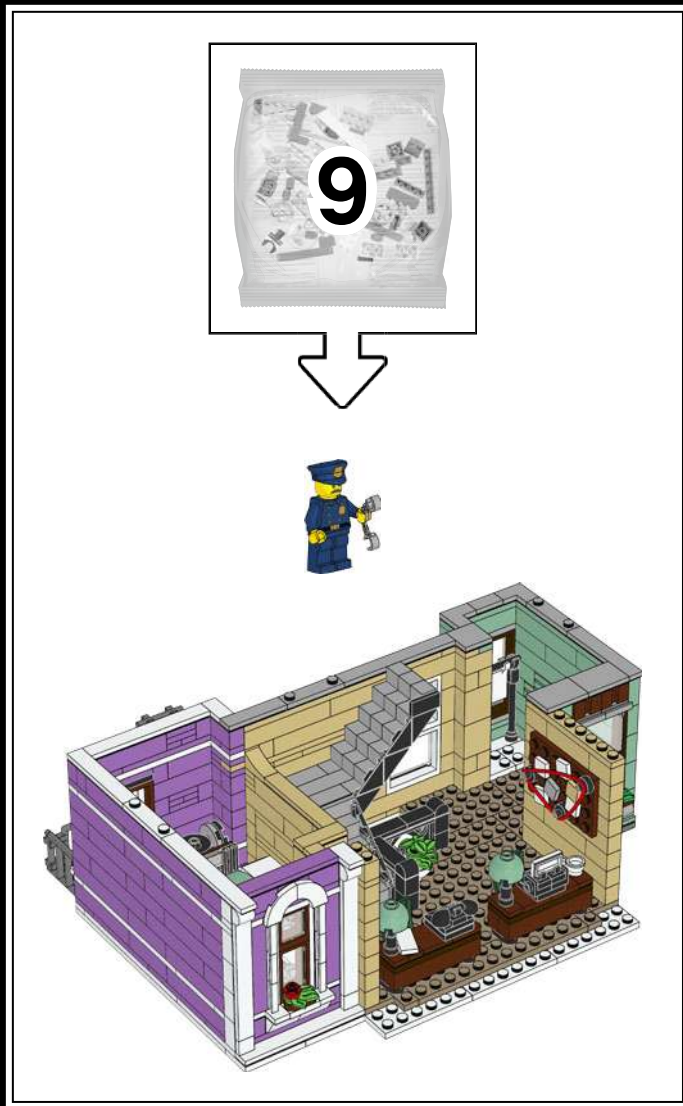

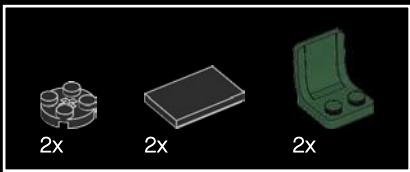

218

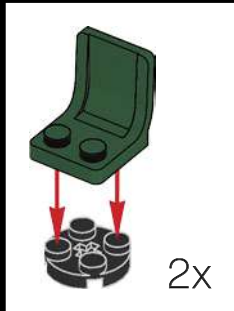
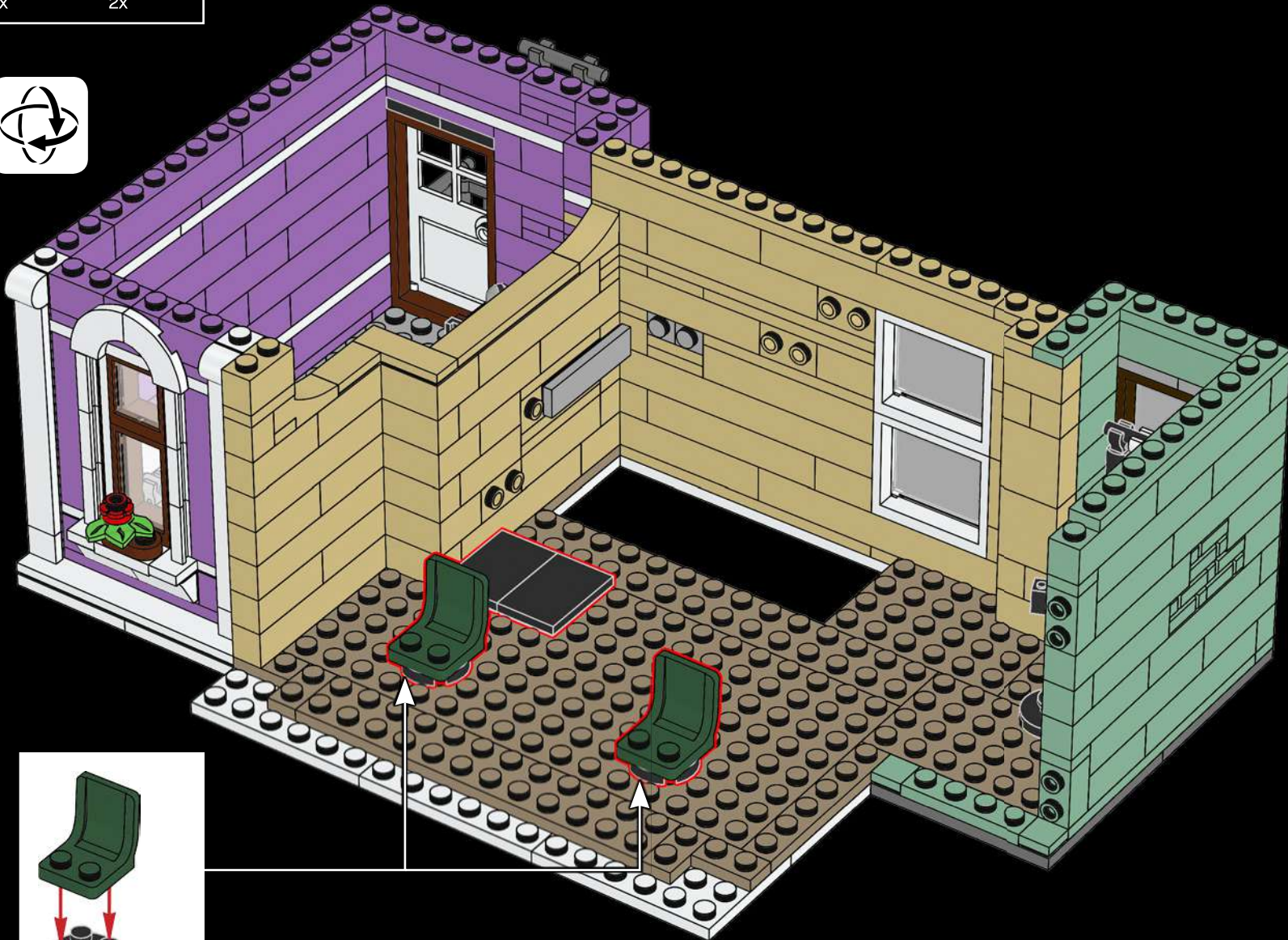

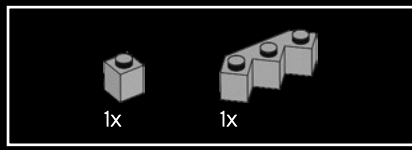

219

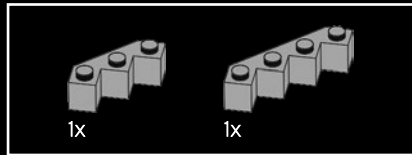
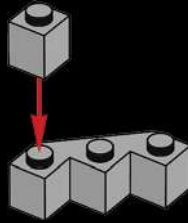

220

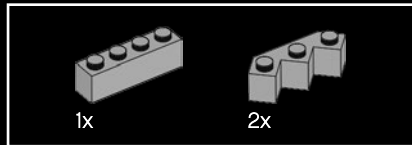
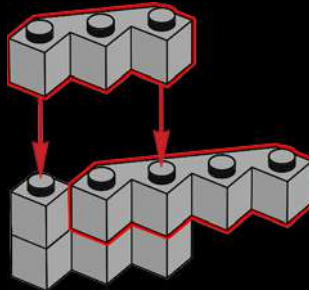

221

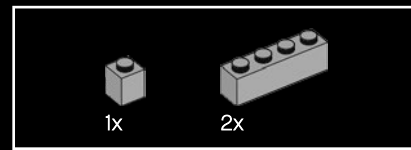
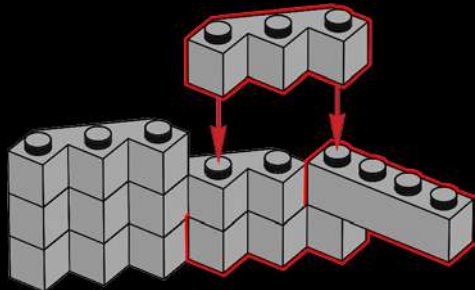

222

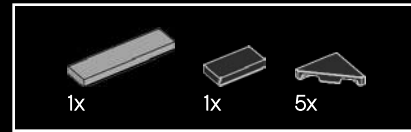
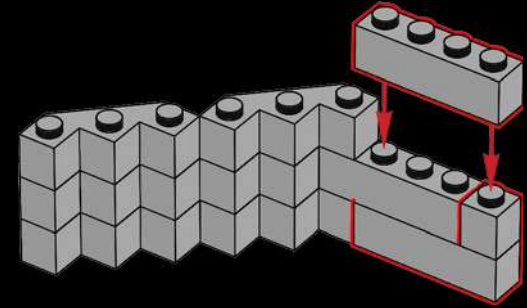

223

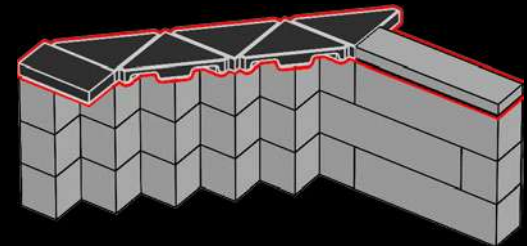

224

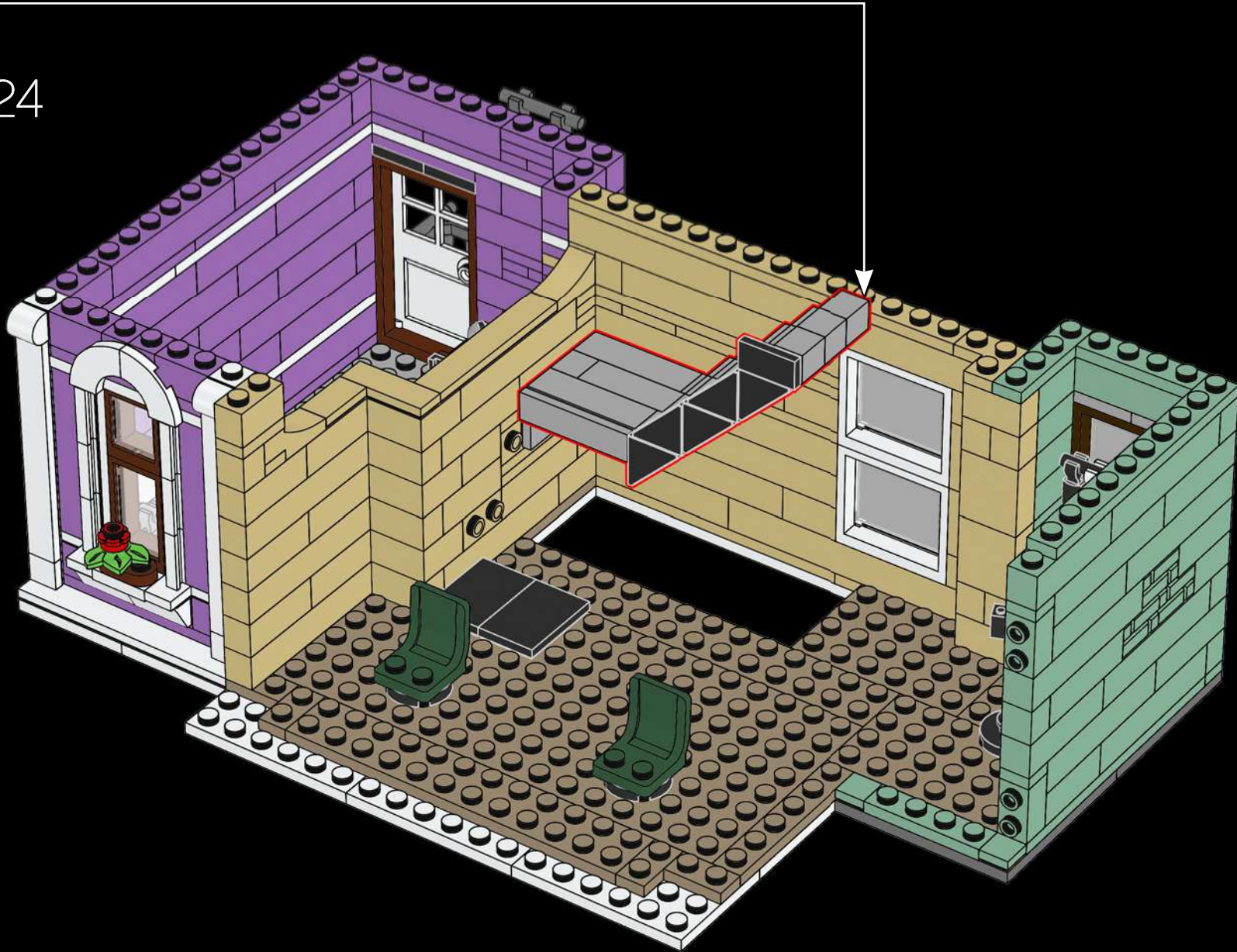

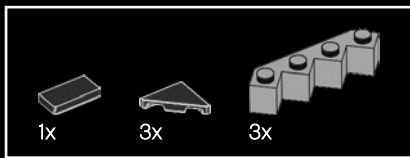

225

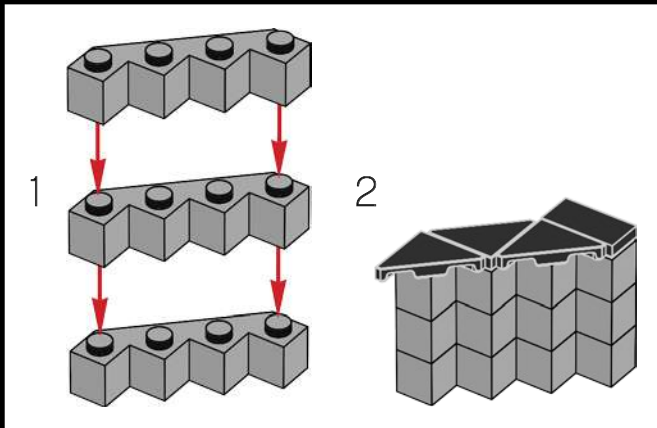
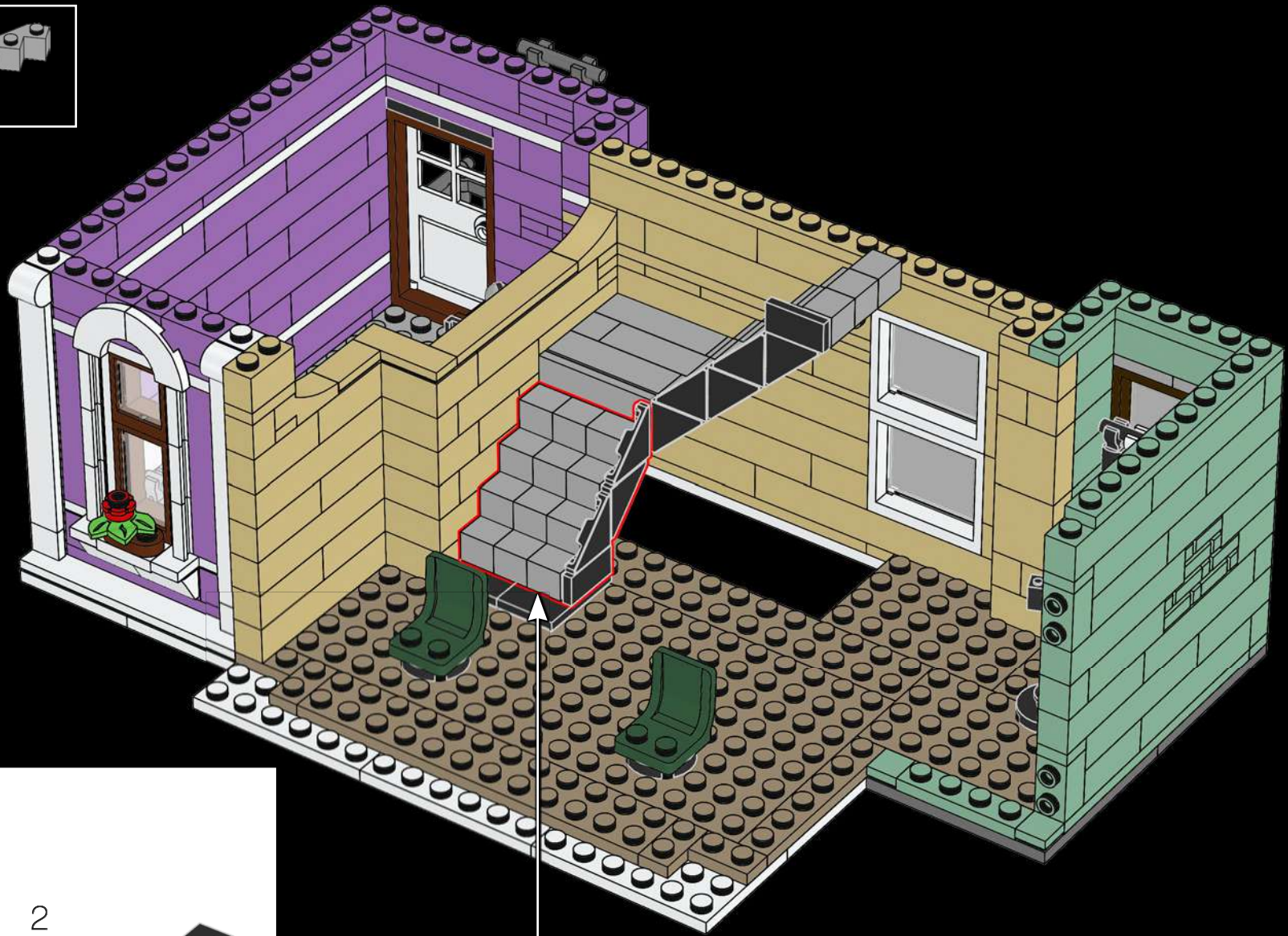

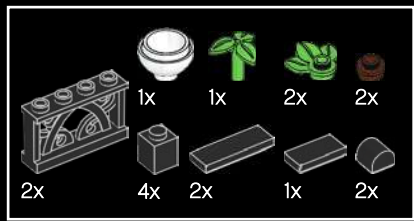

226

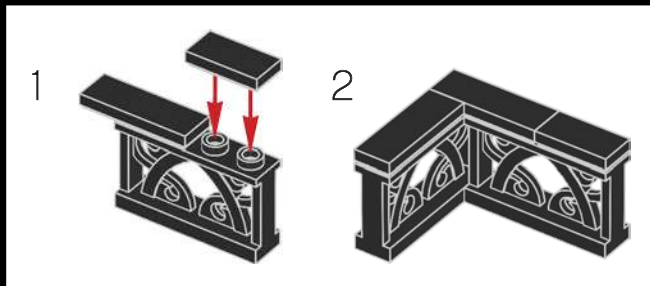
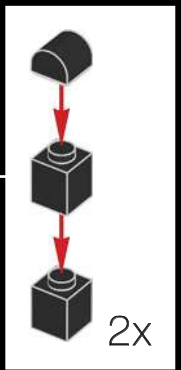

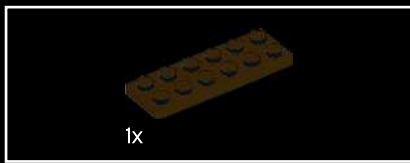

227



229

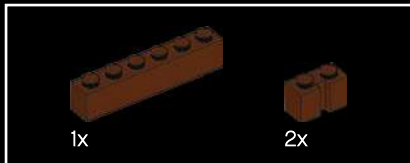
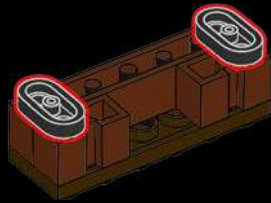

228

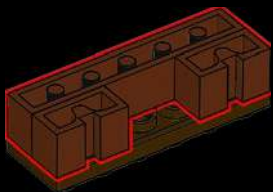

230

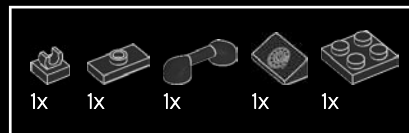
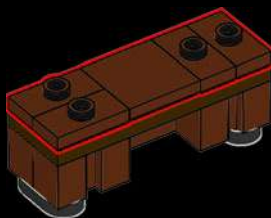

231

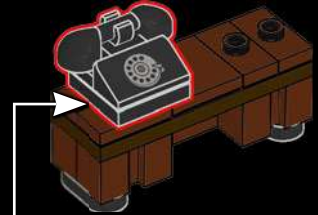
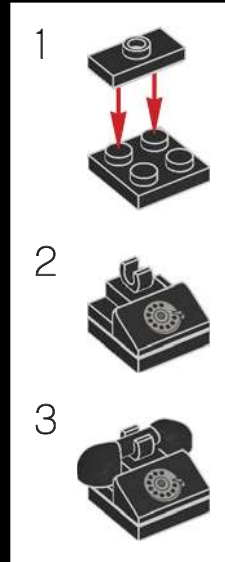

232

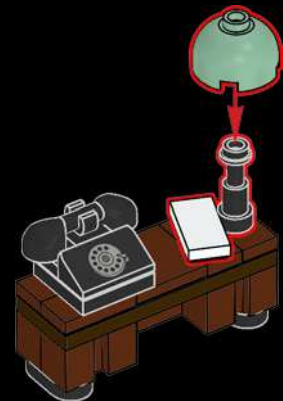

233



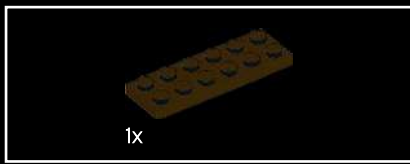

234

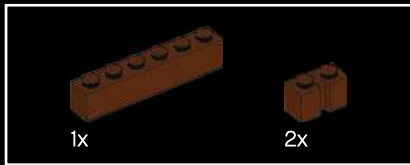

235

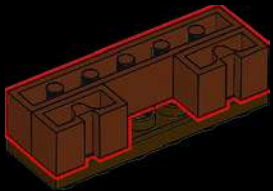

236

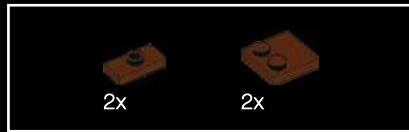
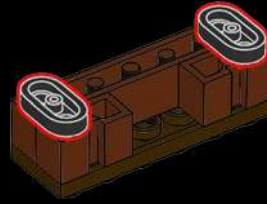

237

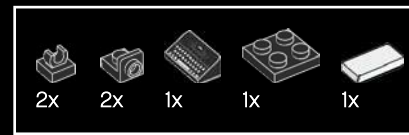
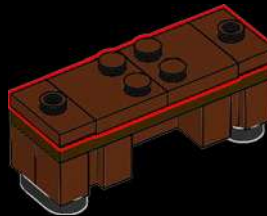

238

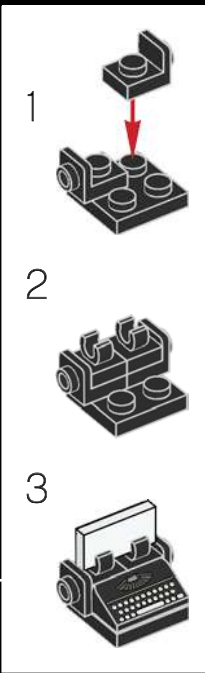
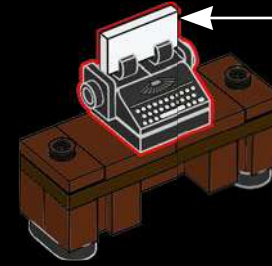

239



240



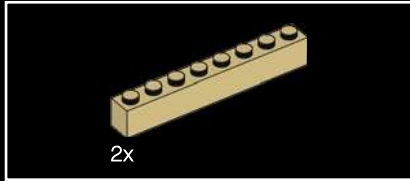
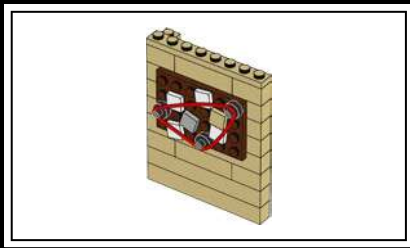

2x

241

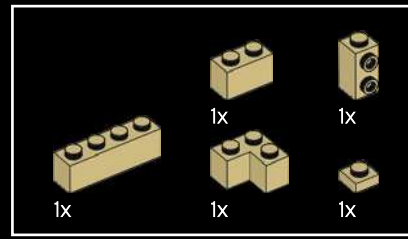
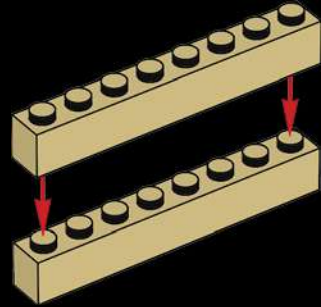

242

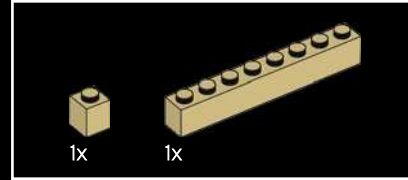
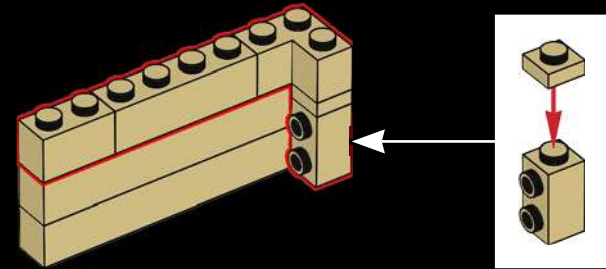

243

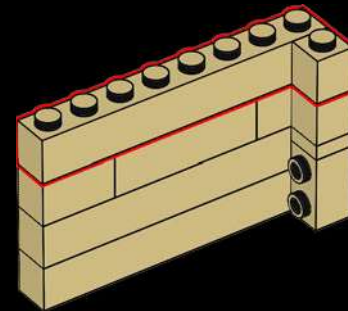

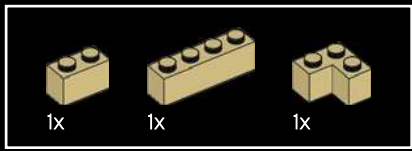

244

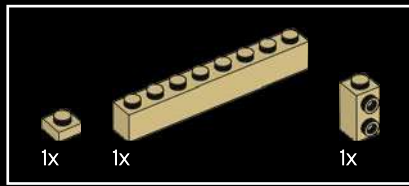
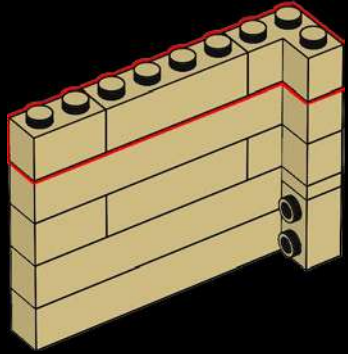

245

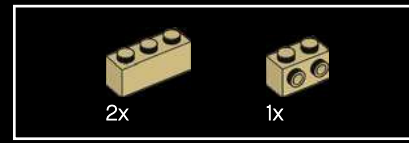
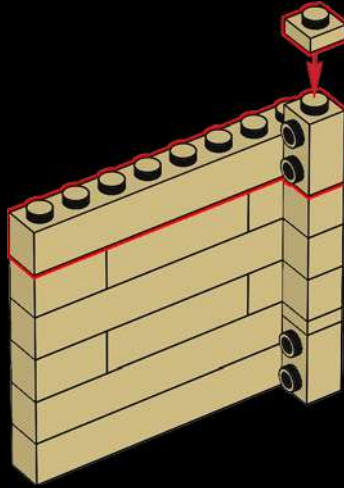

246

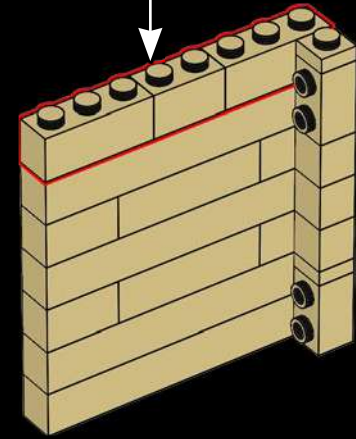
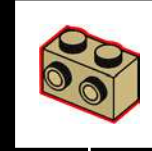

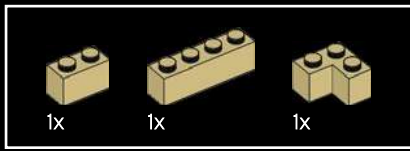

247

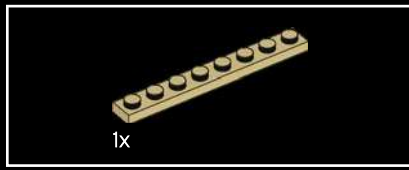
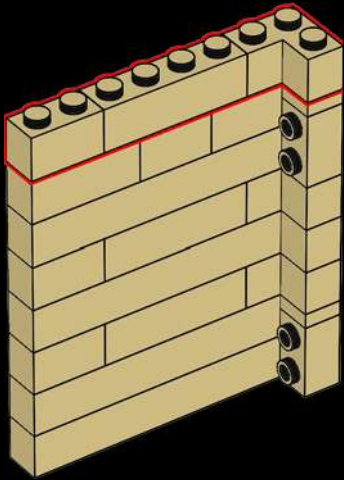

248

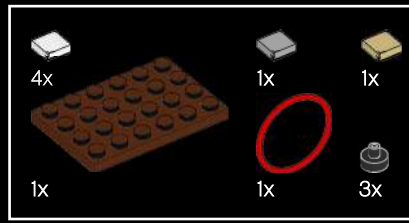
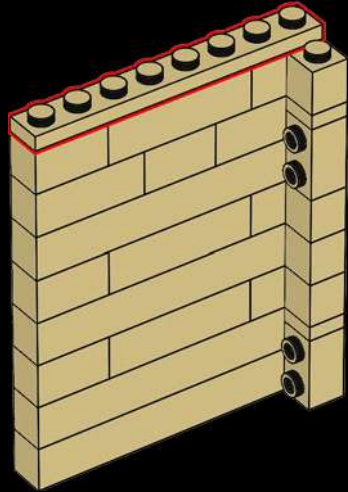

249

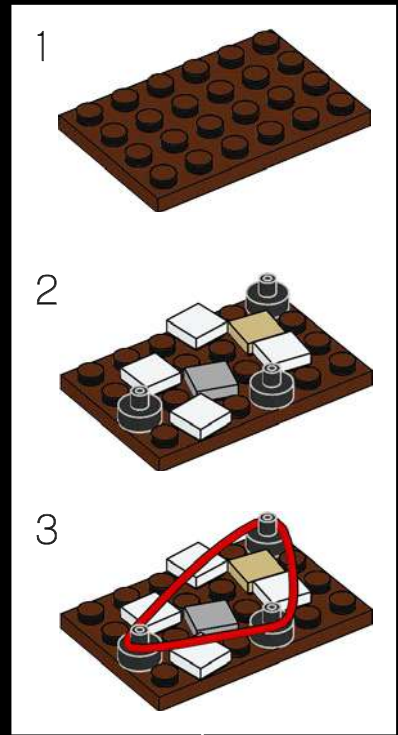
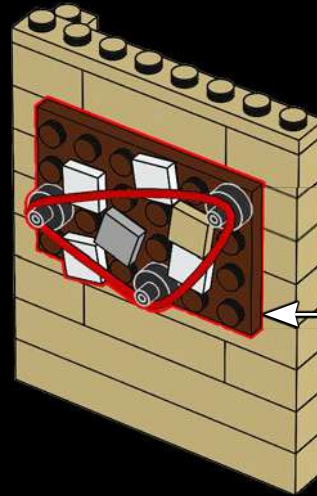

250

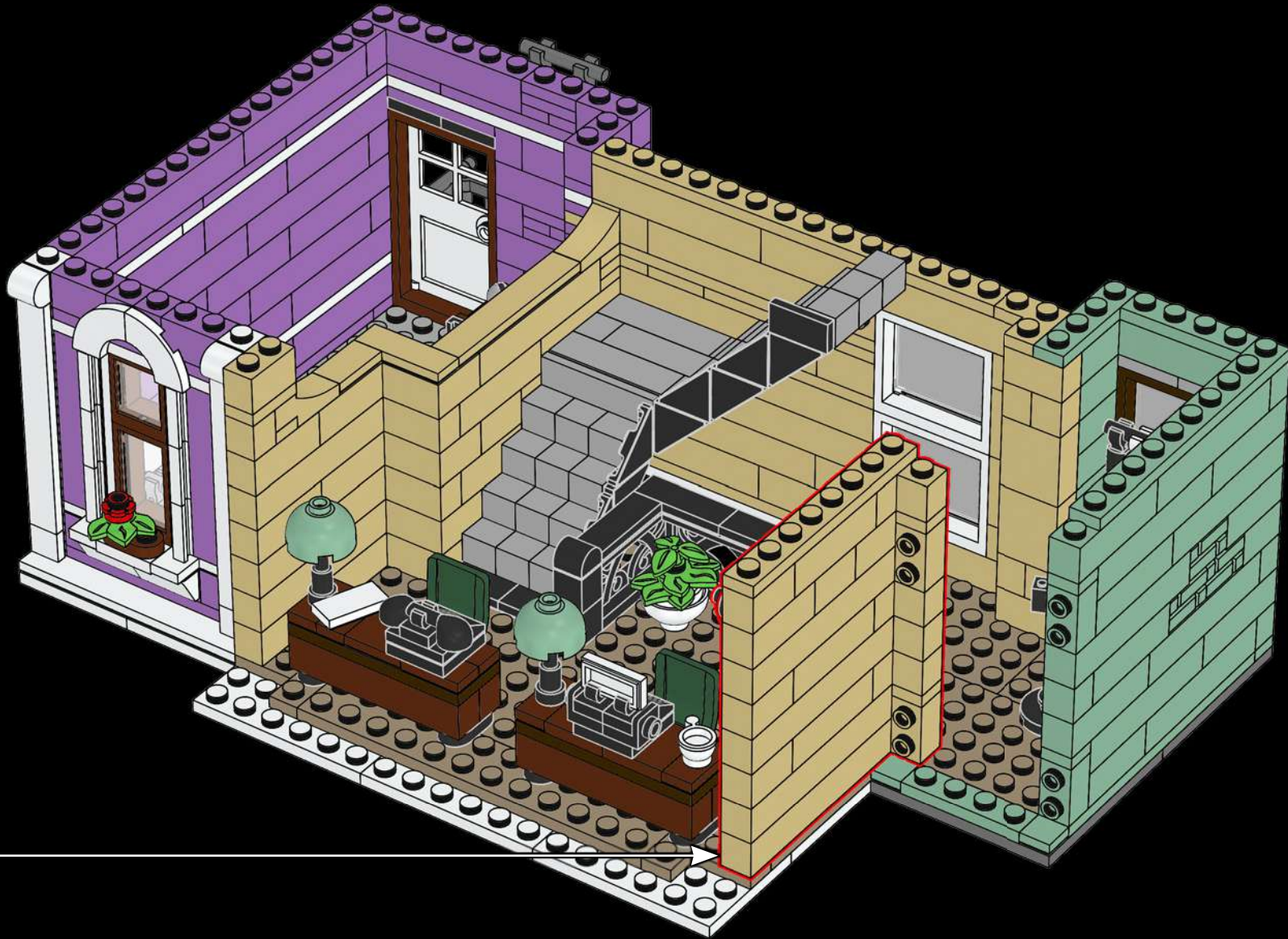

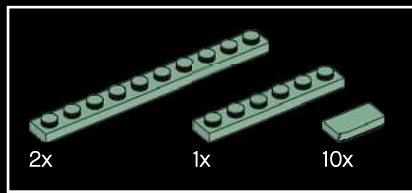

251

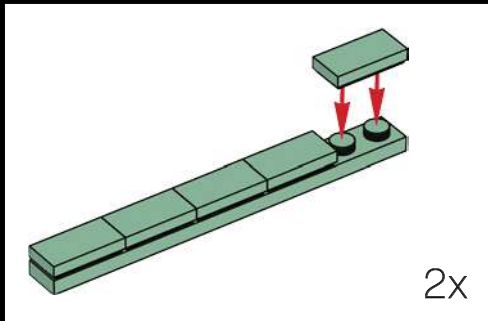
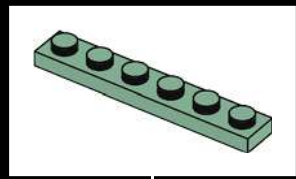
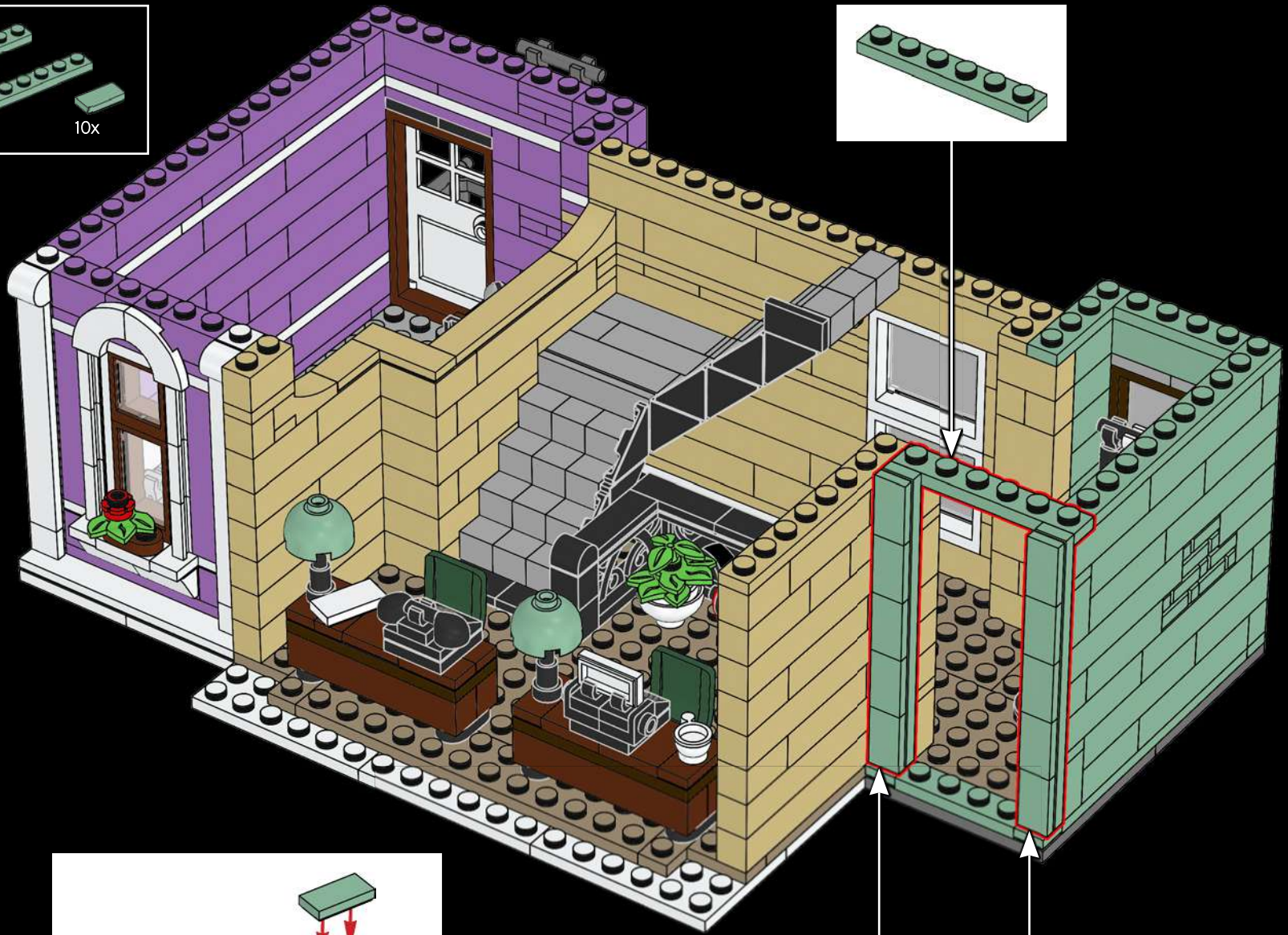



252

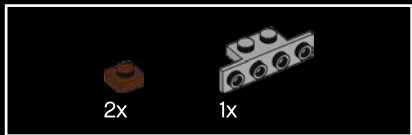
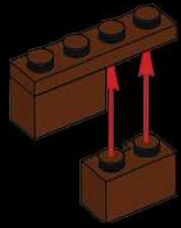

253

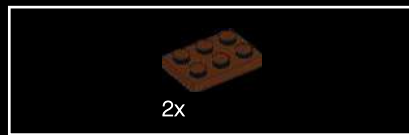
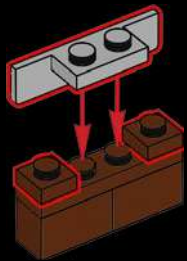

254

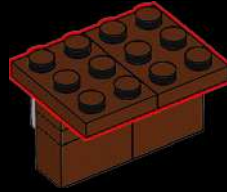

255

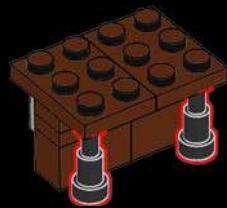

256

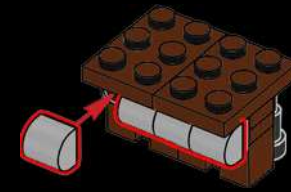

257





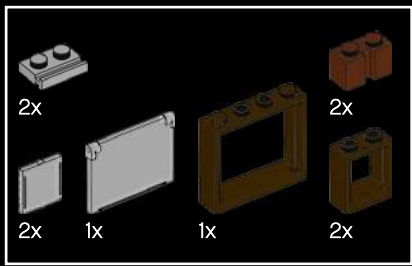

258



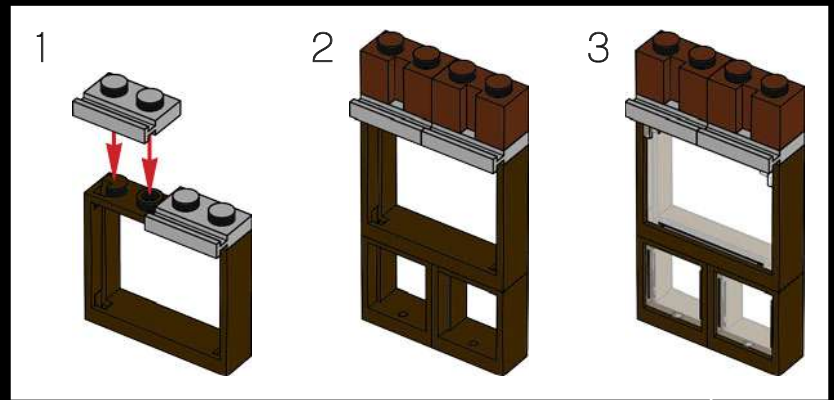

259



- 
1x
- 
2x
- 
1x
- 
1x

260

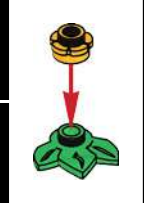
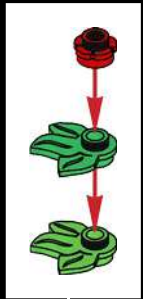

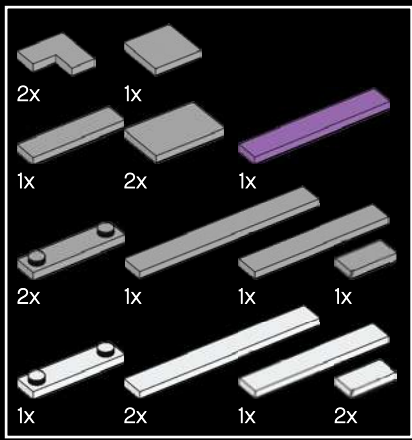

261





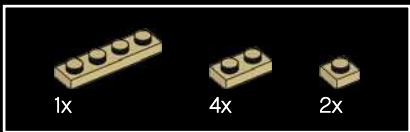

262



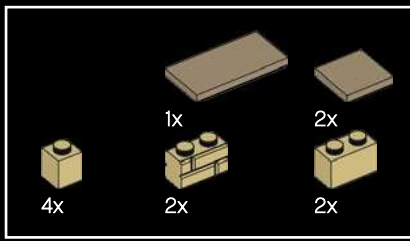

263



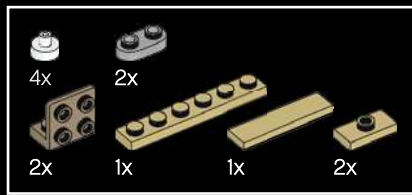

265

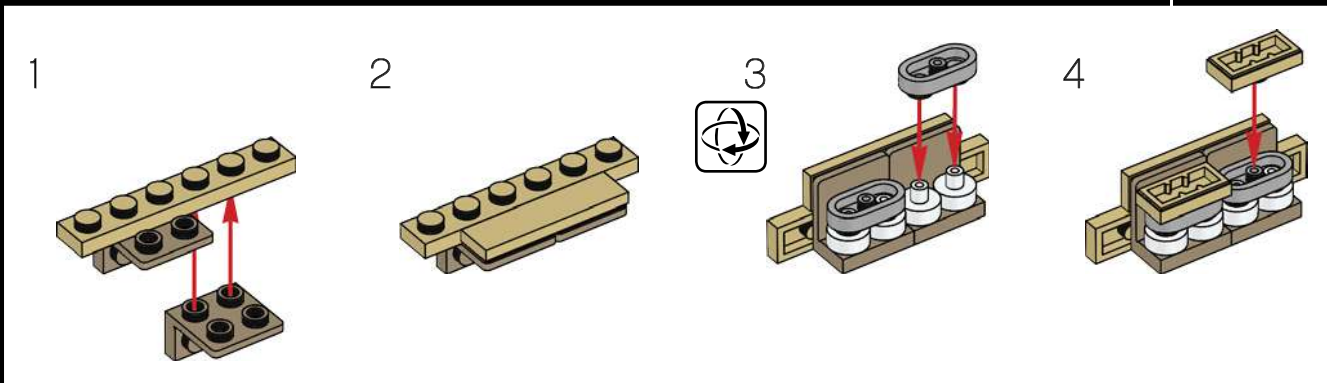

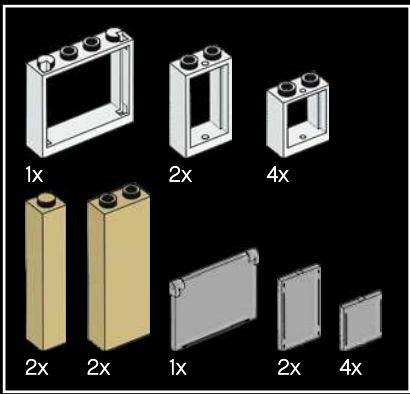

266

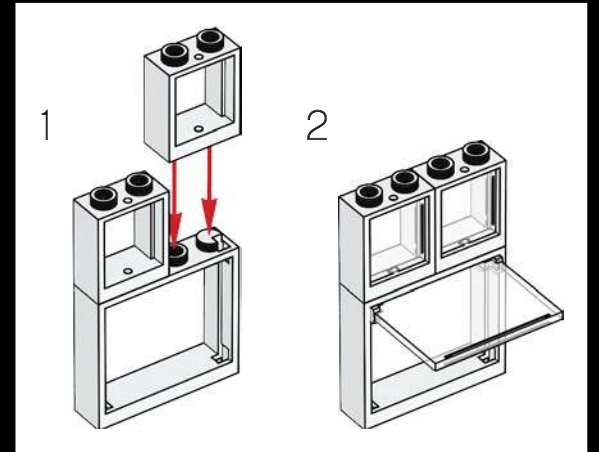
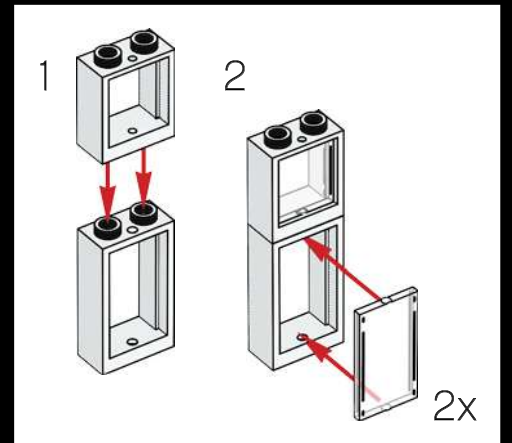

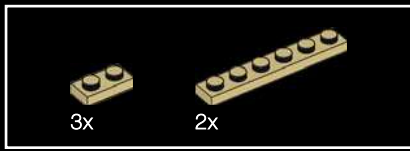

267

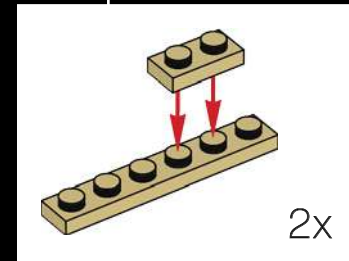

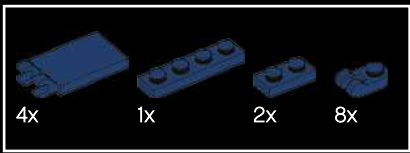

268

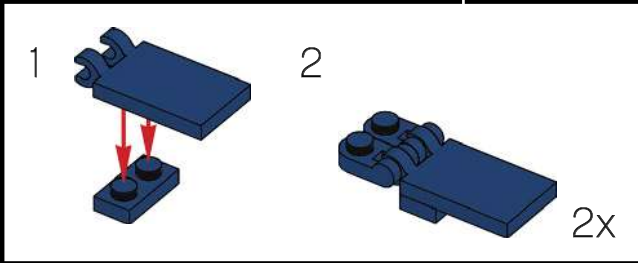
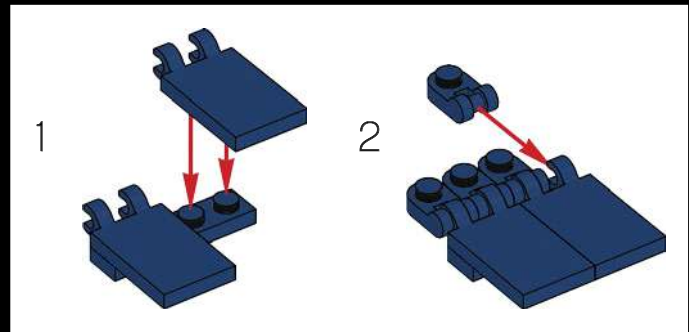

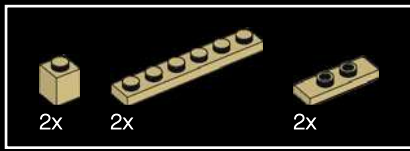

269

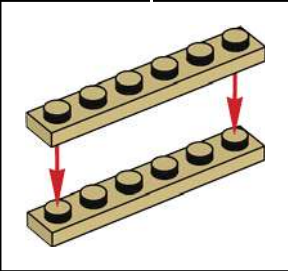

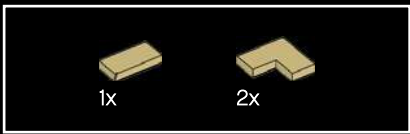

270



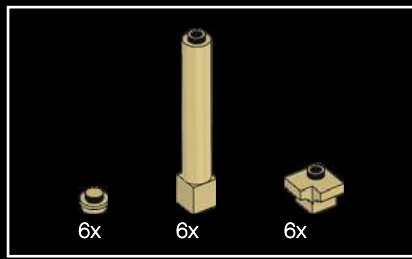

271

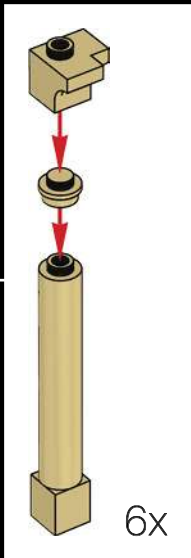

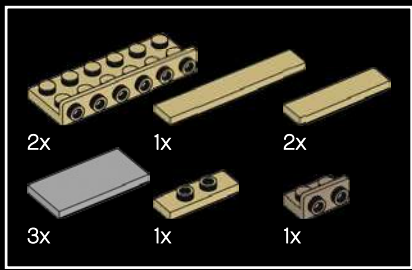

272

1

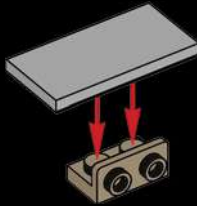

2

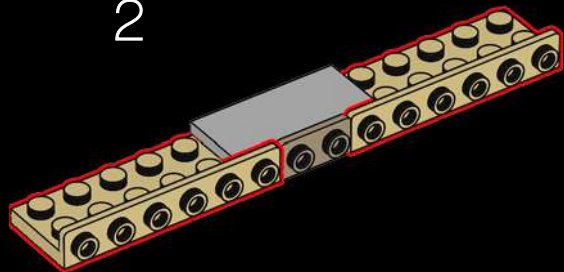

3

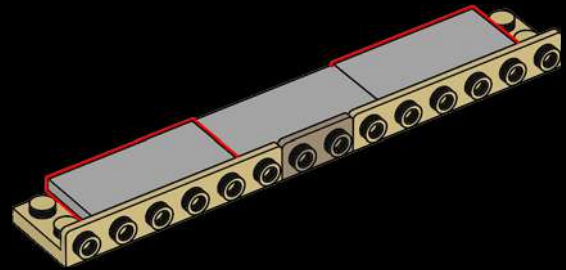

4

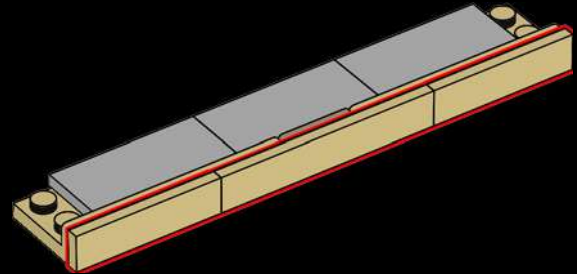

5

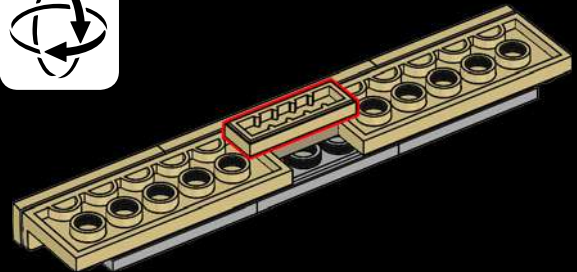

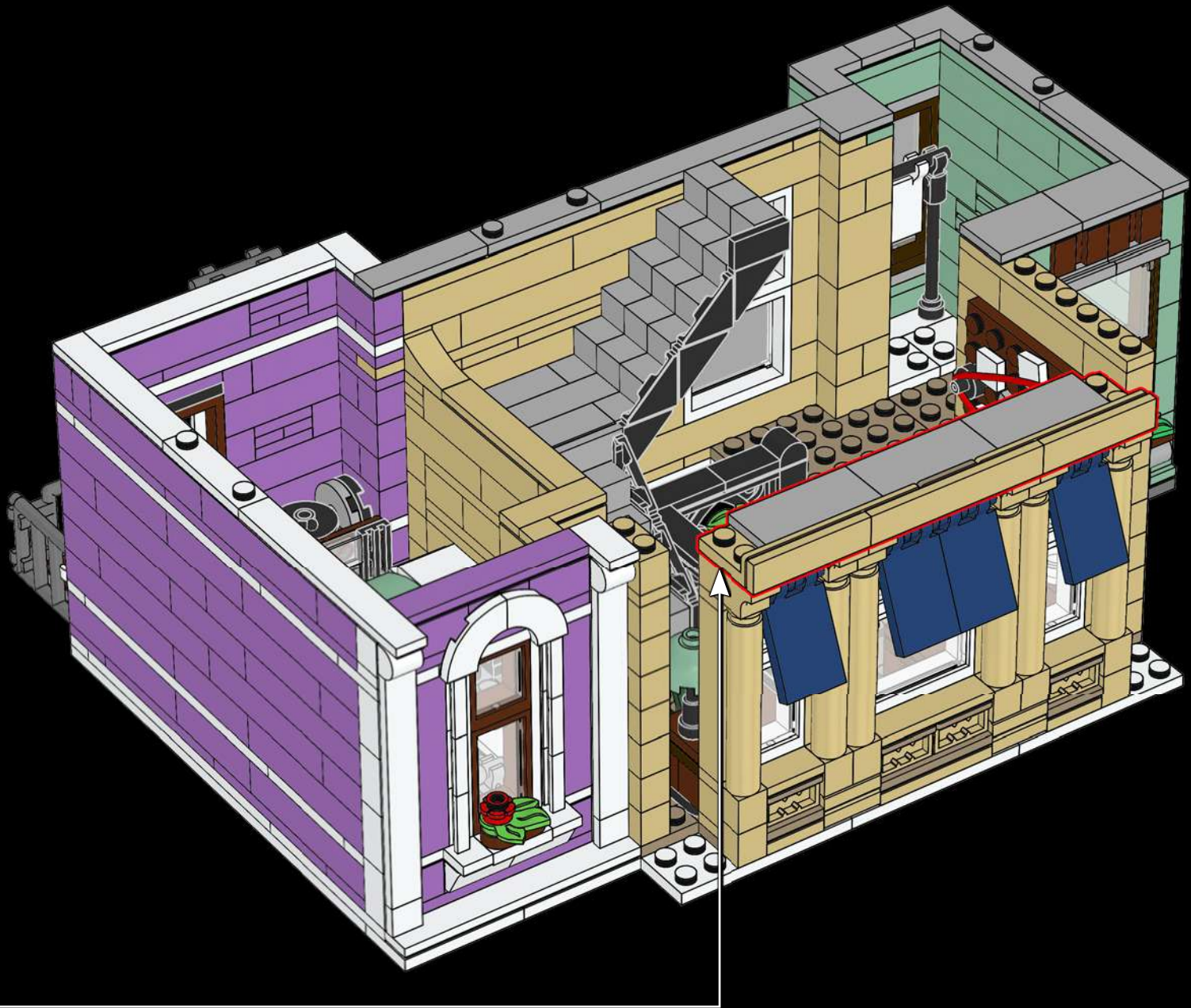

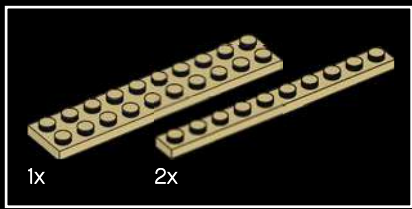

273

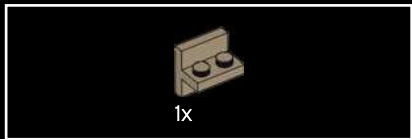
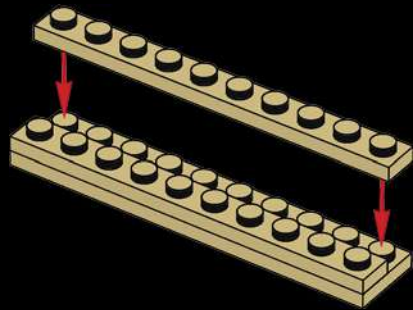

274

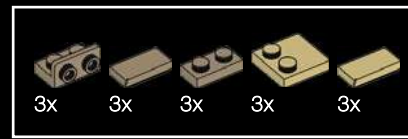
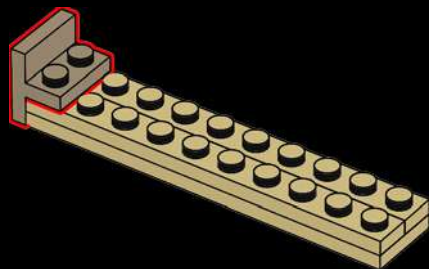

275

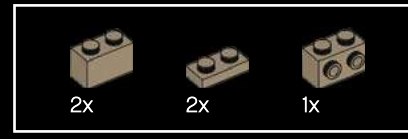
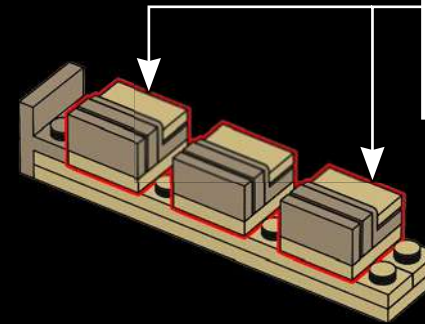

276

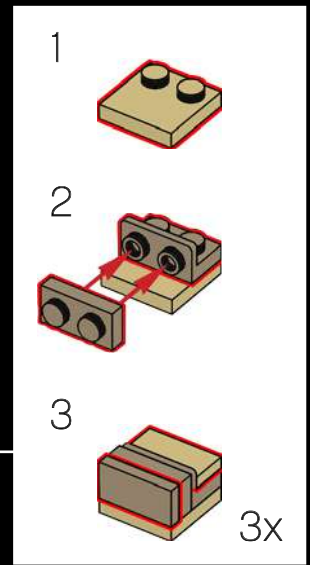
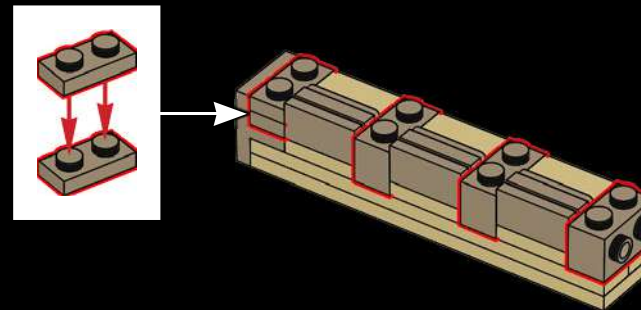



277

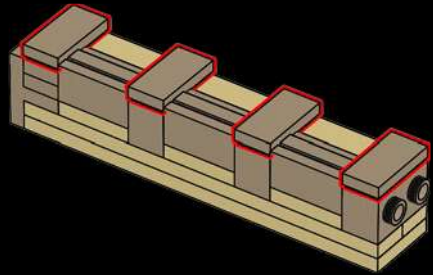

278



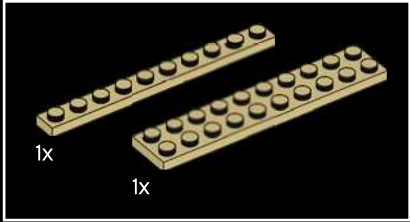
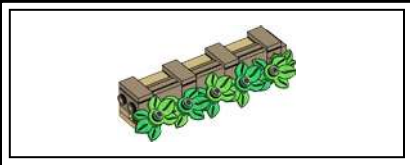

279

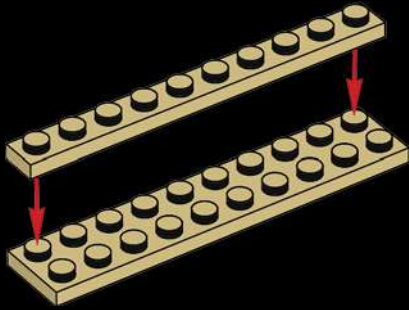

280

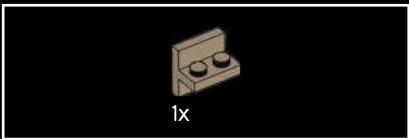
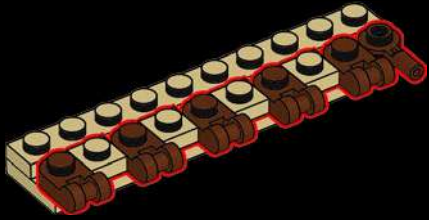

281

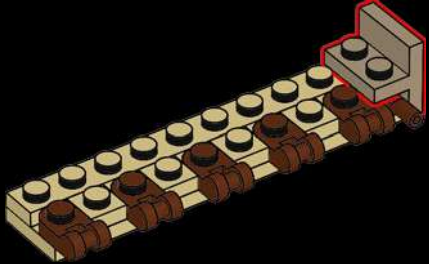

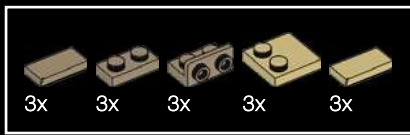

282

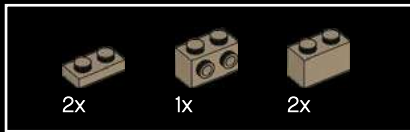
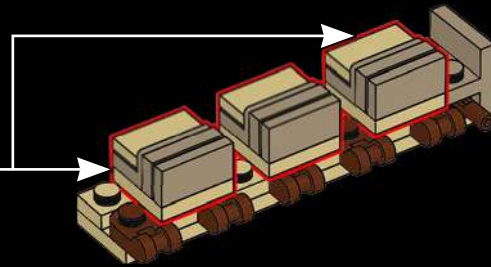
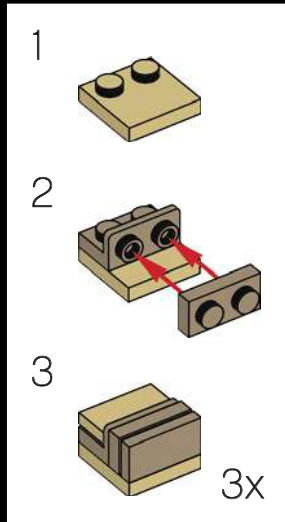

283

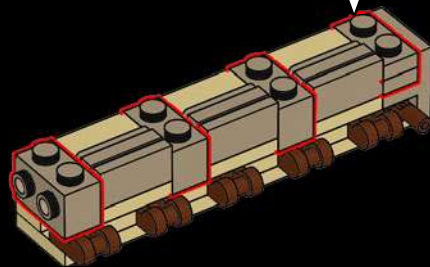
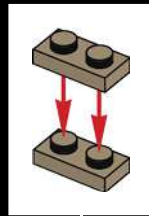

284

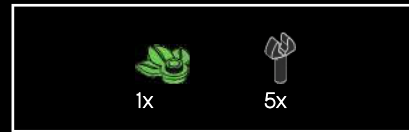
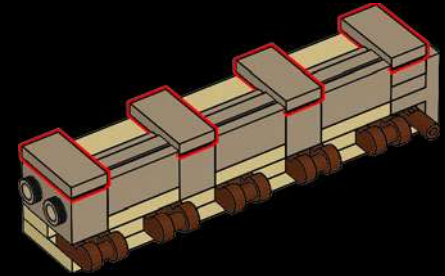

285

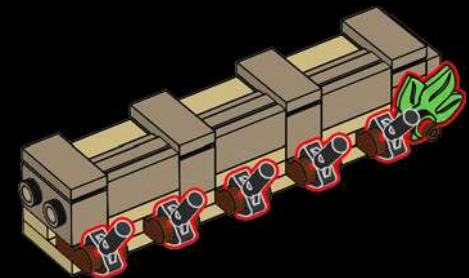

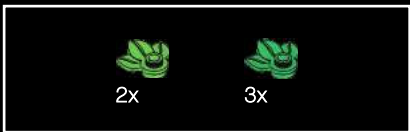

286

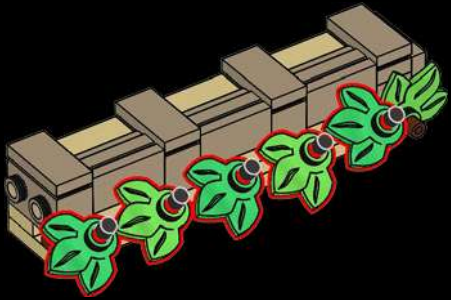

287

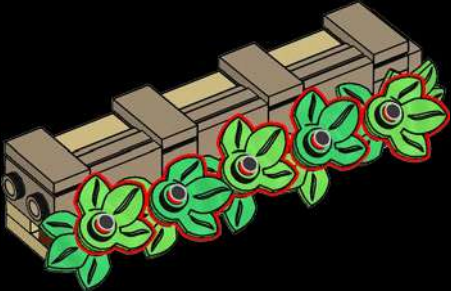

288



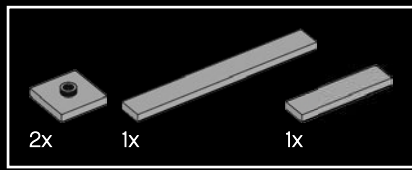

289



290

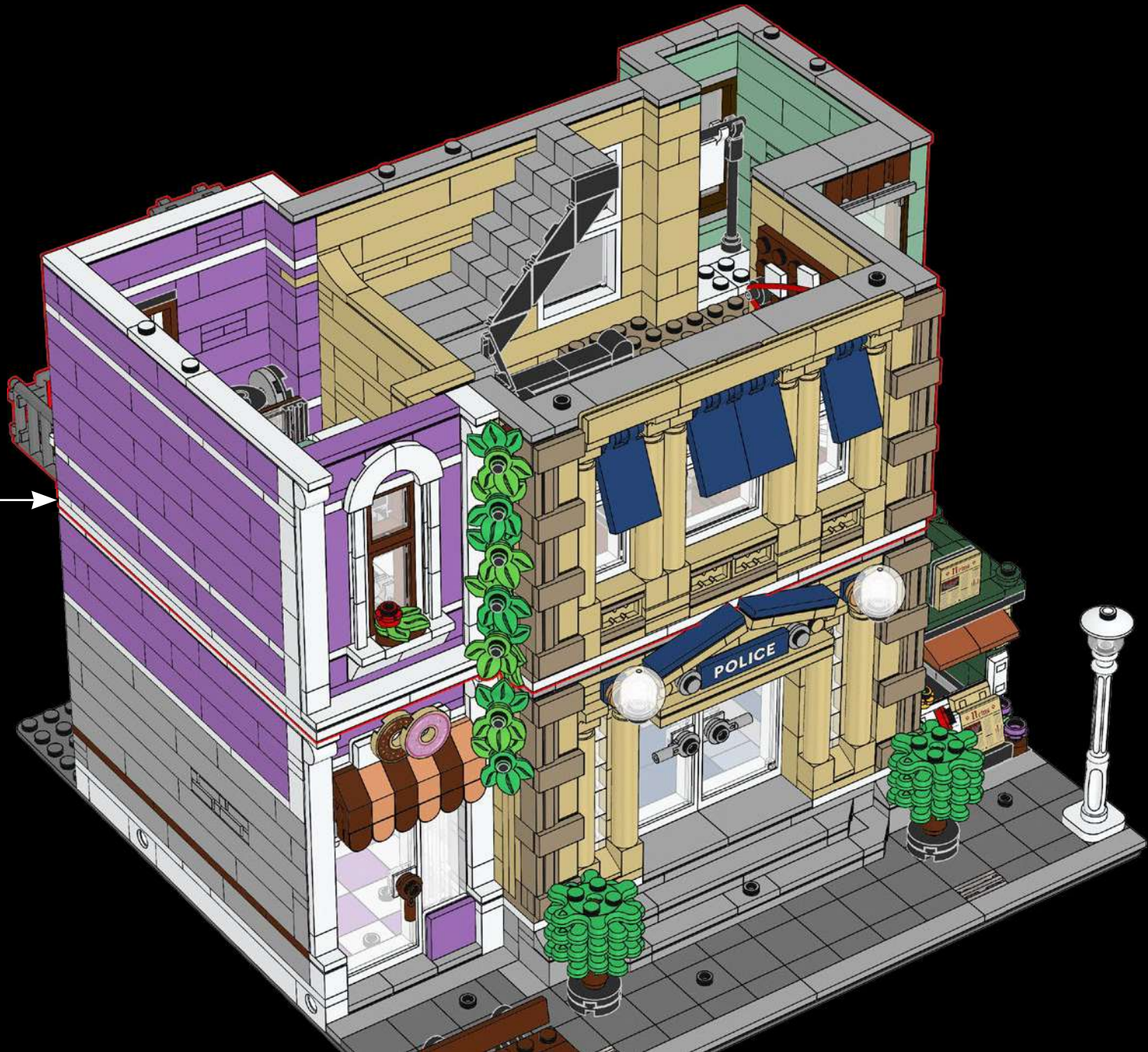

206

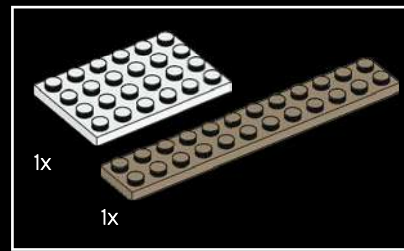
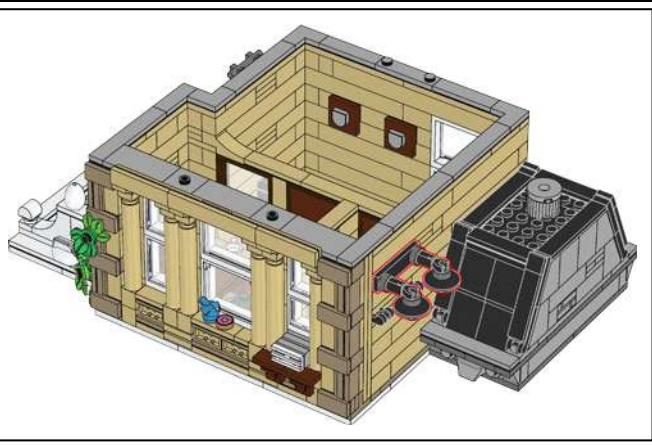
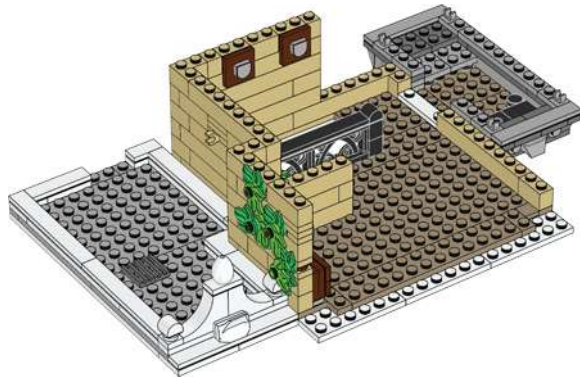
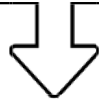
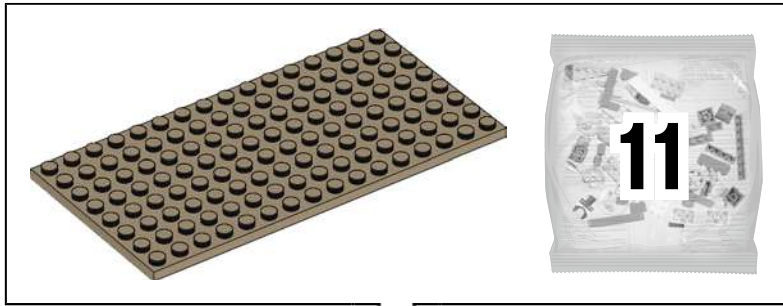

291

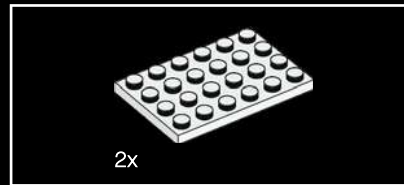
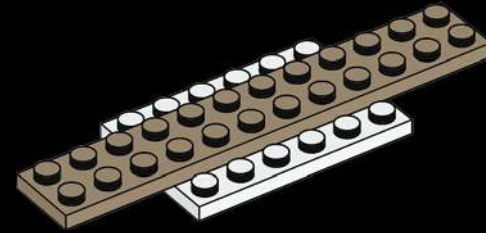

292

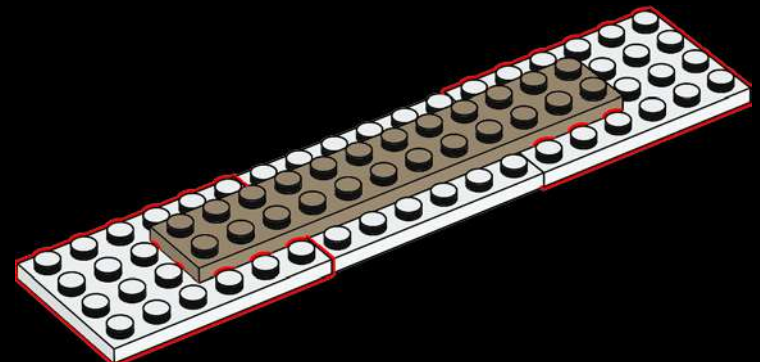



293

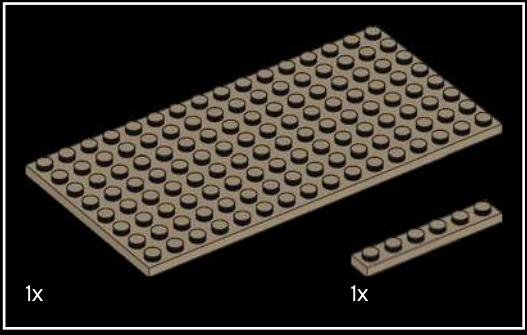
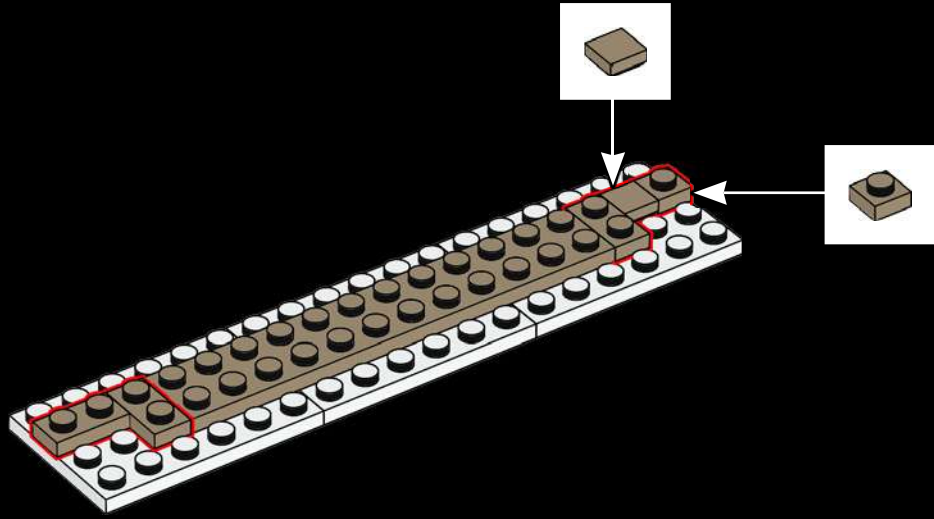

294

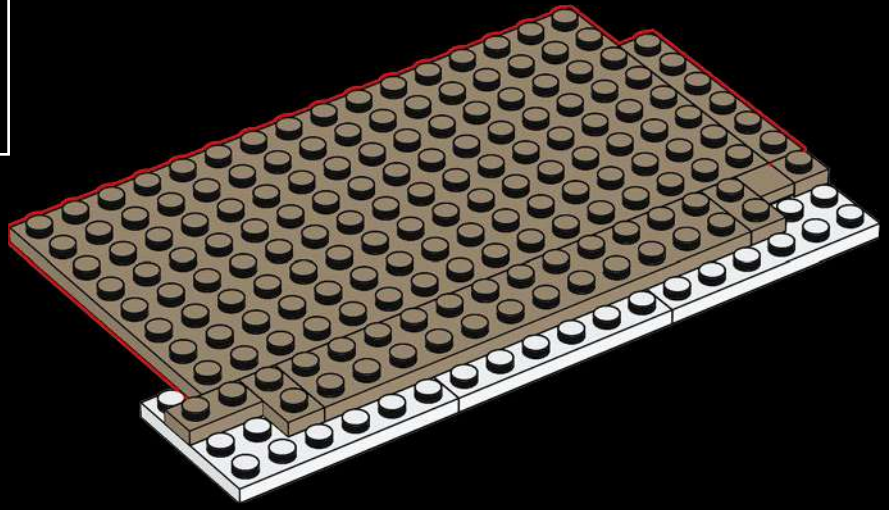

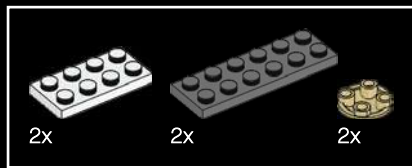

295

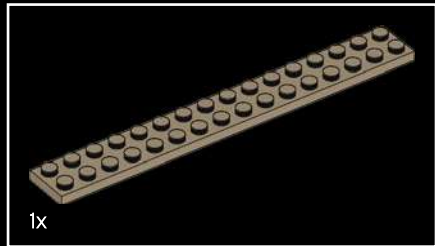
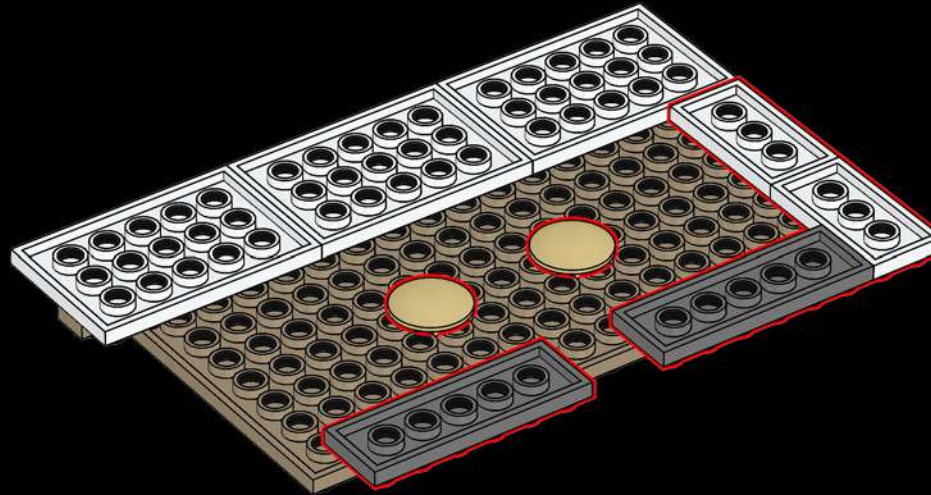

296

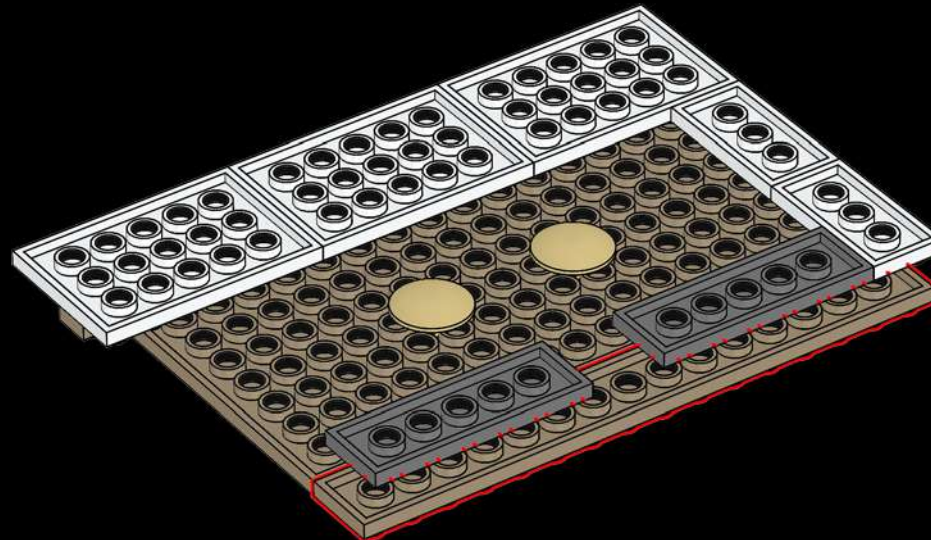

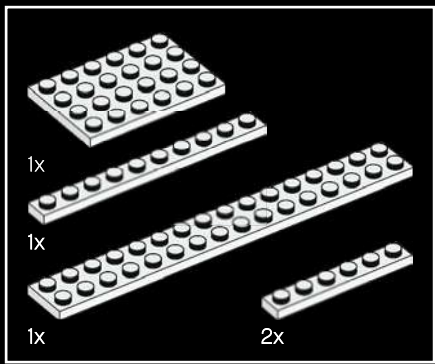

297

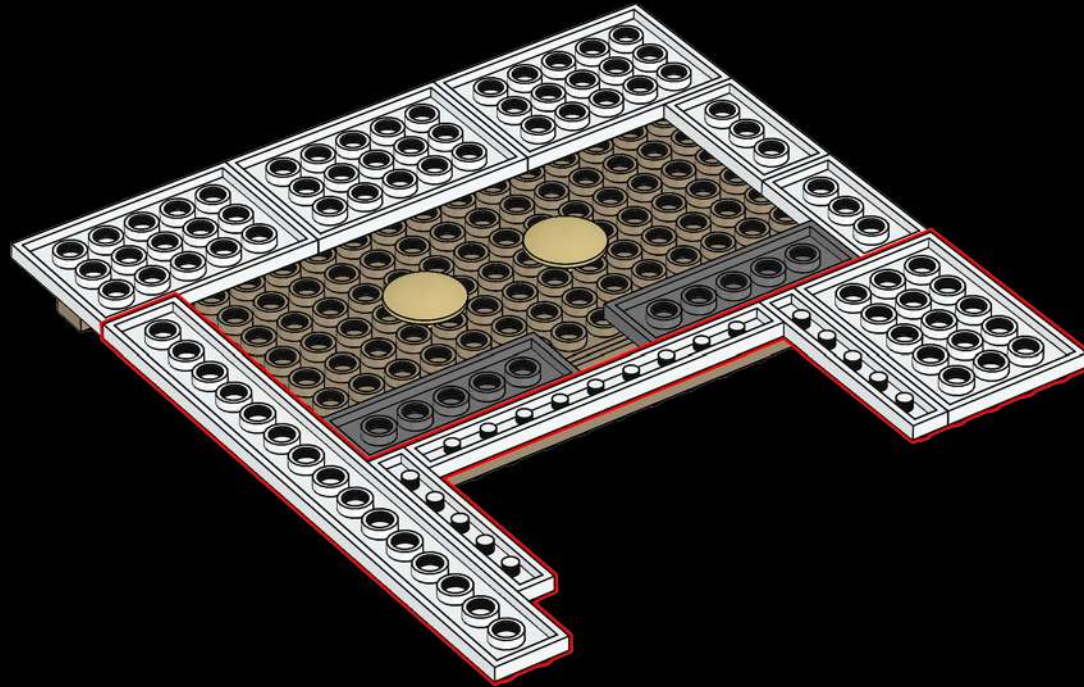

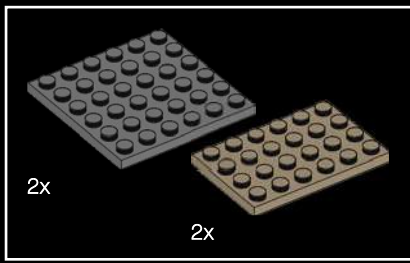

298

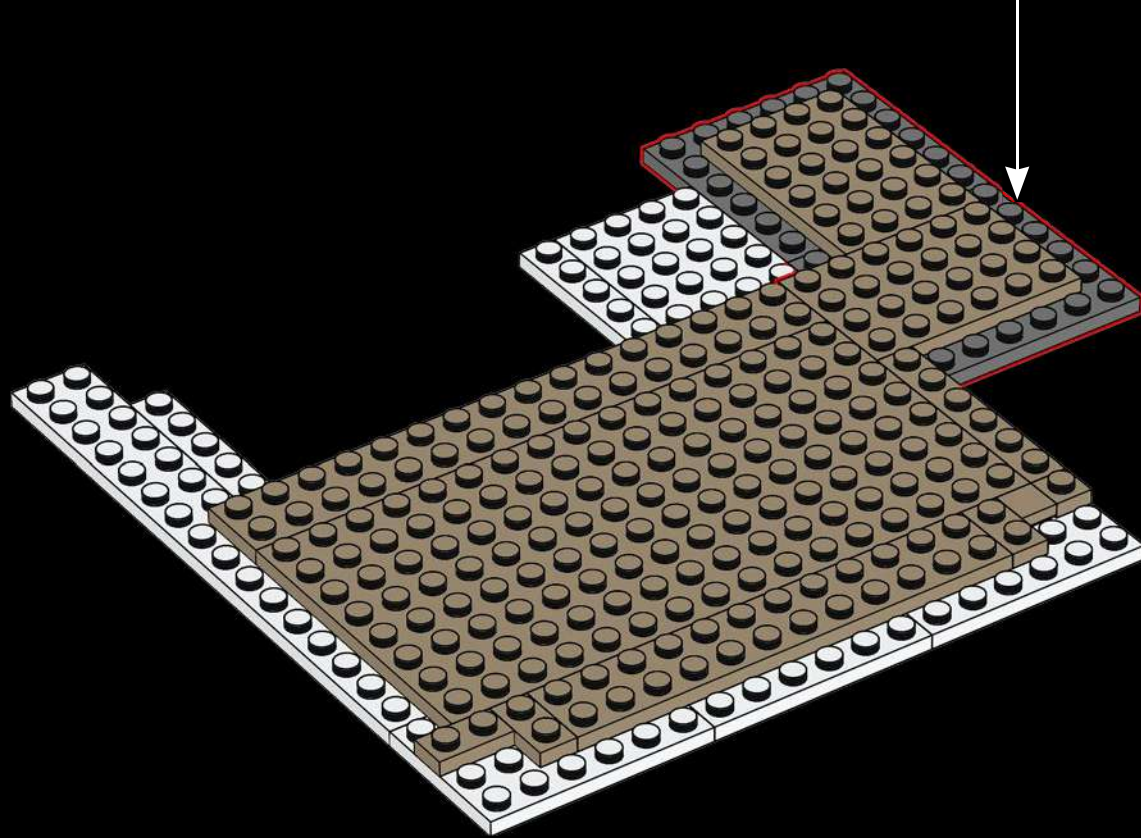
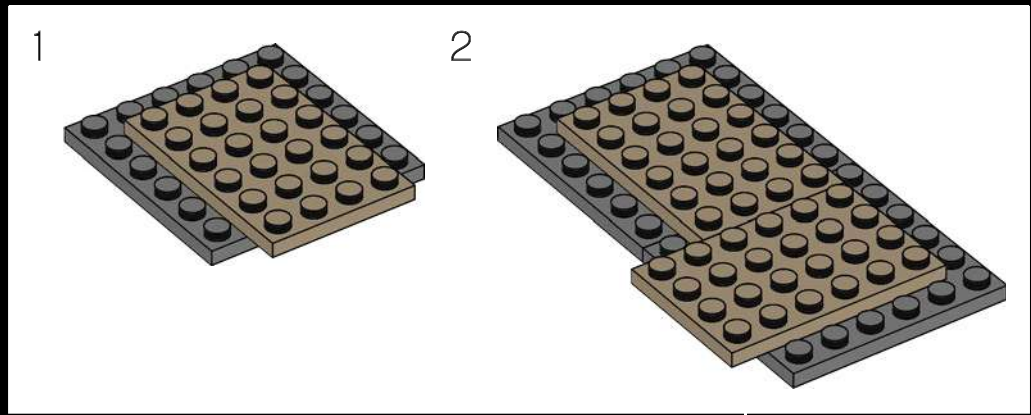

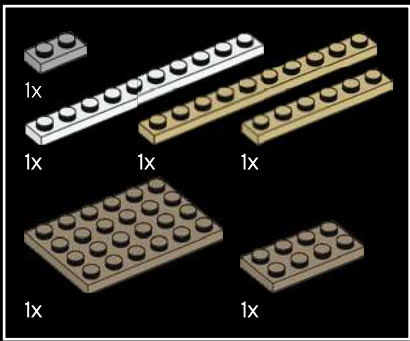

299

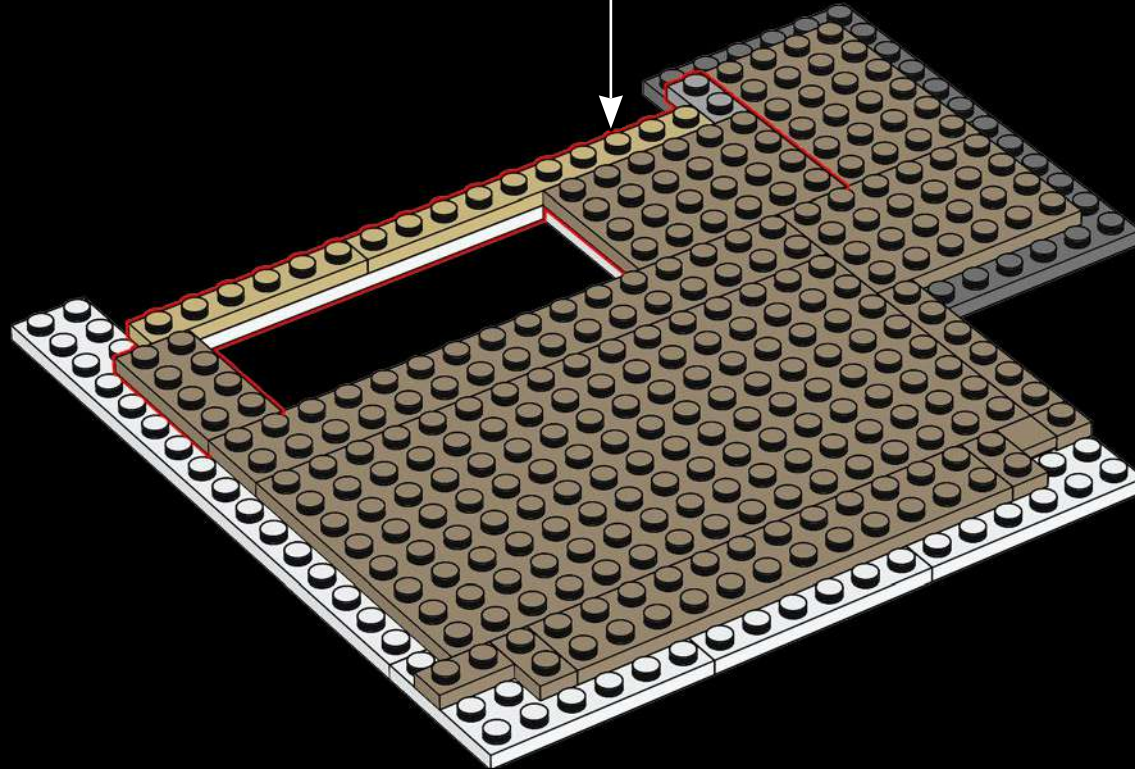
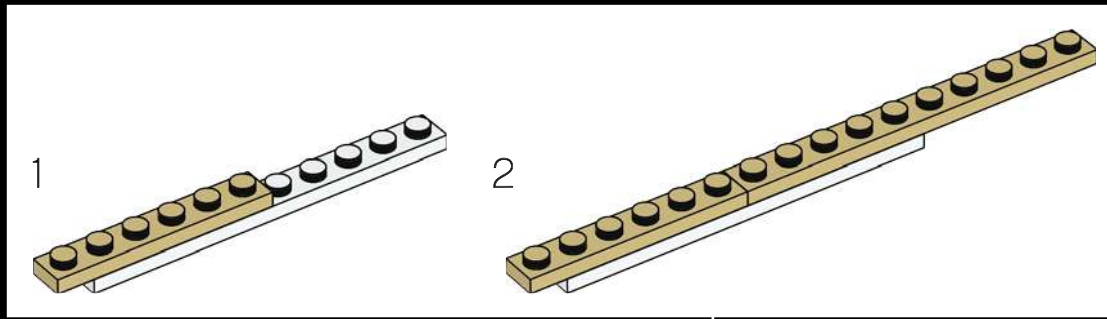

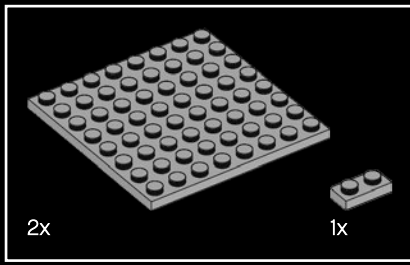

300

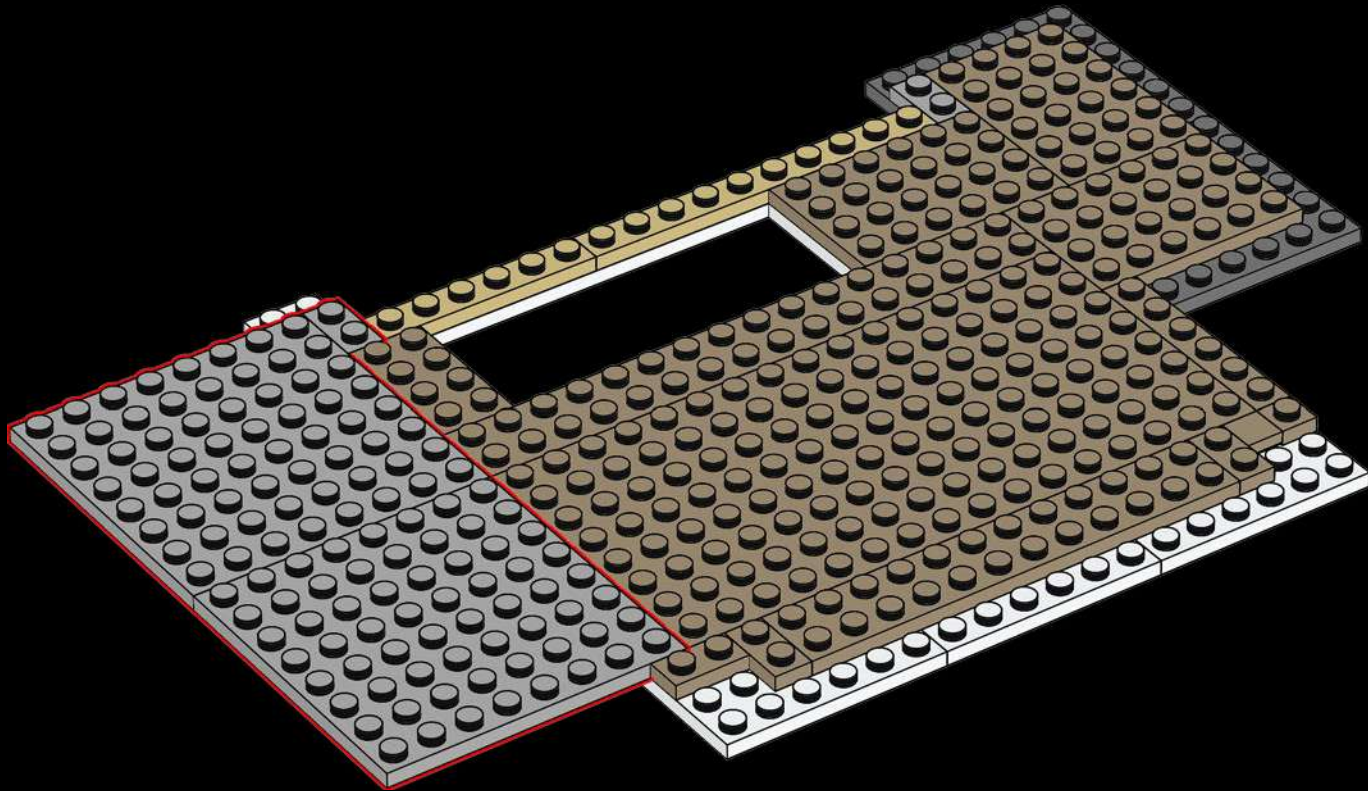

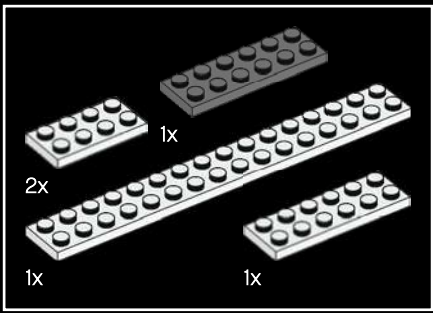

301

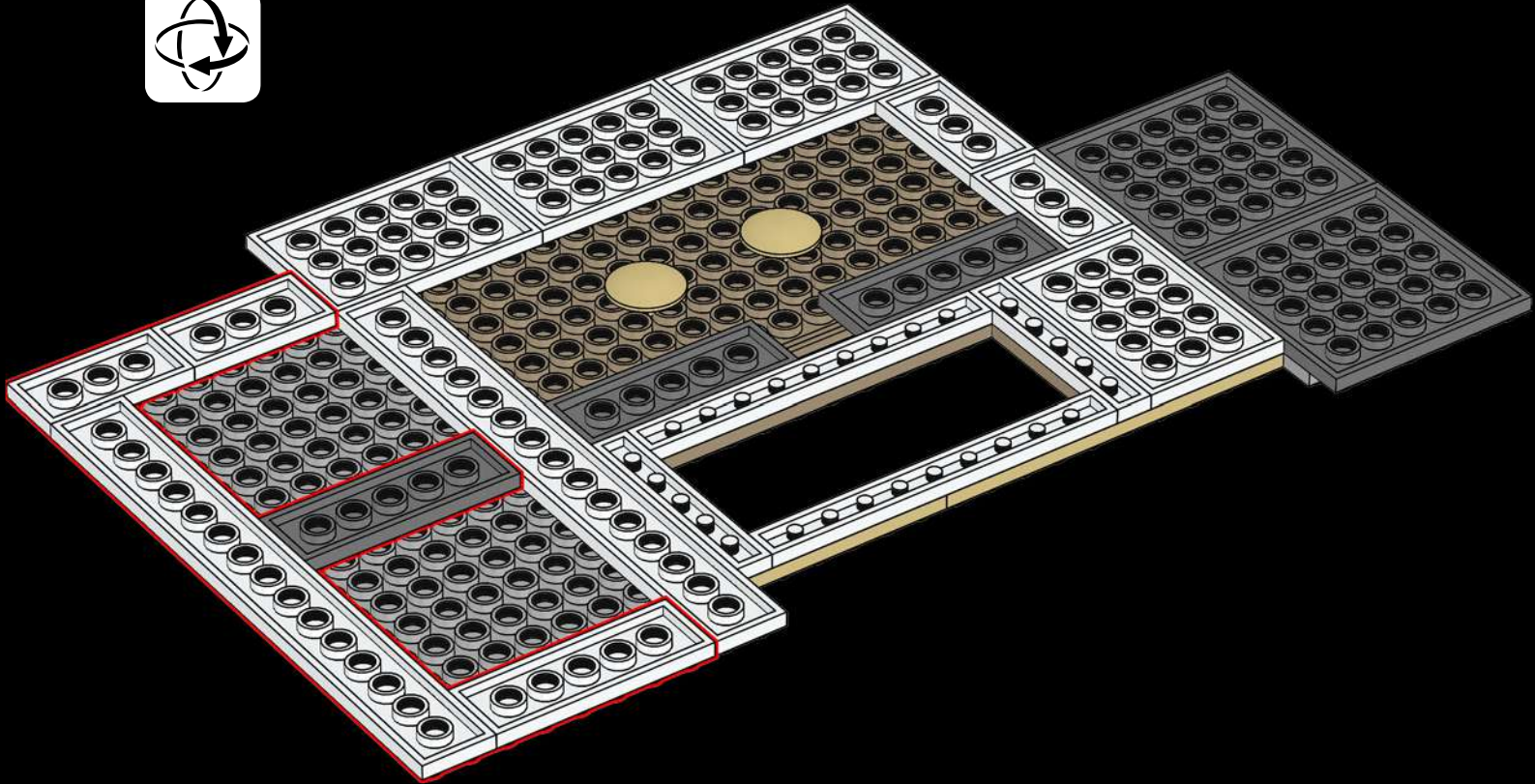

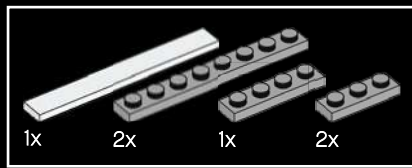

302

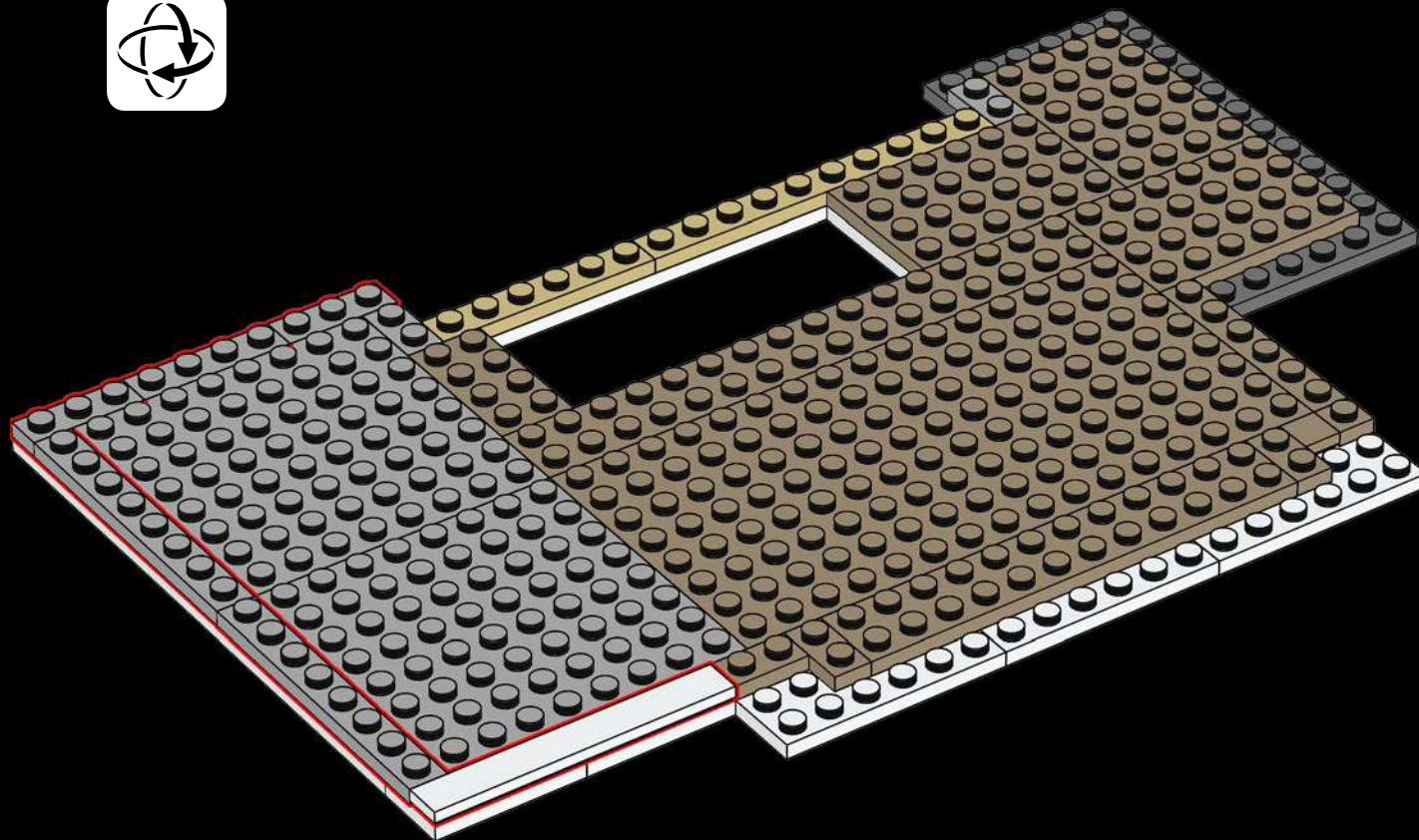

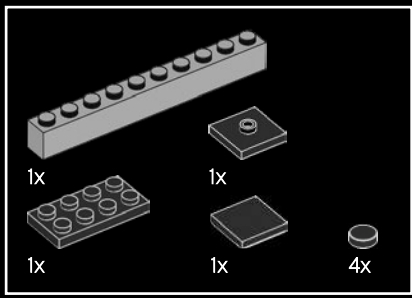

303

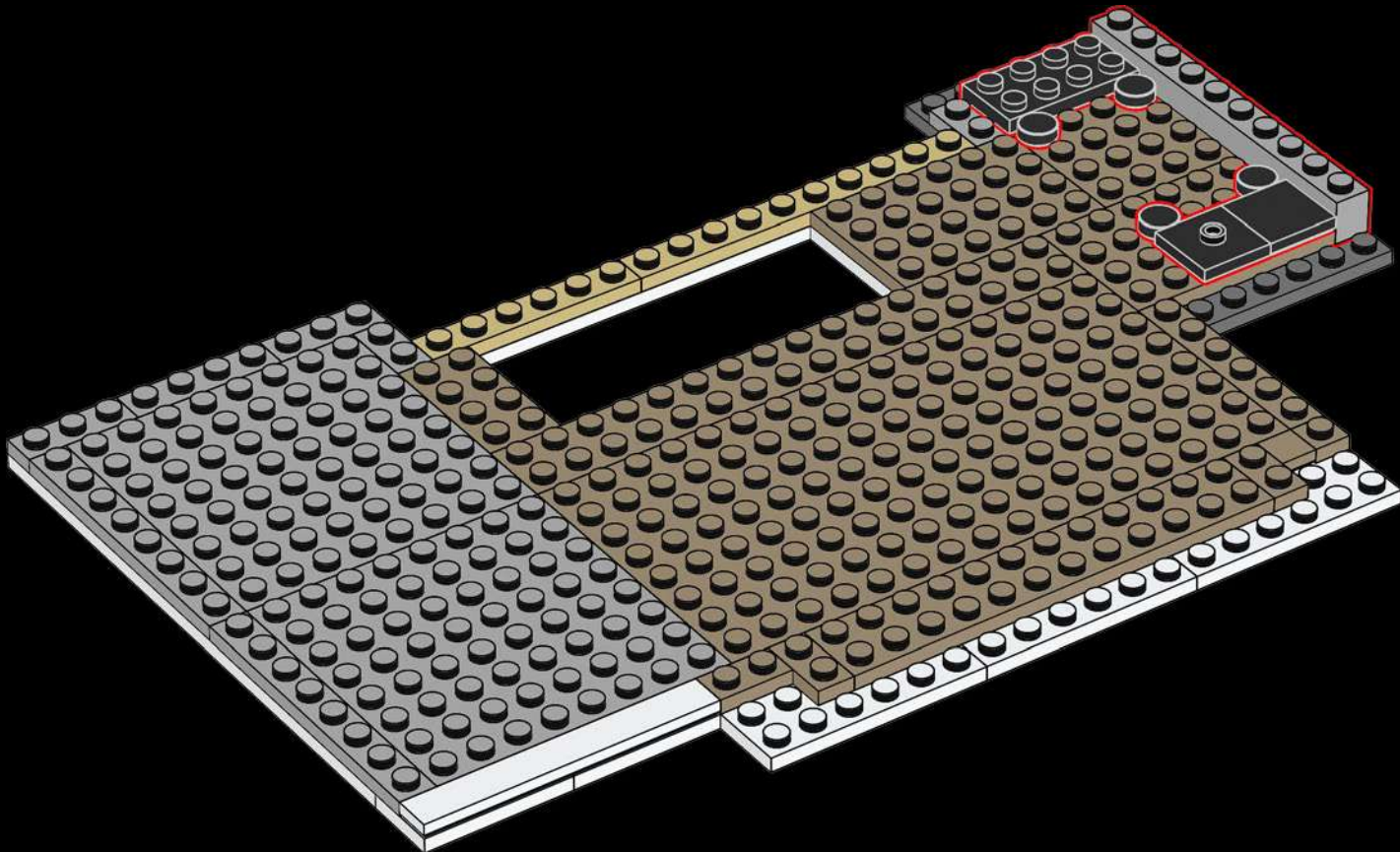



304

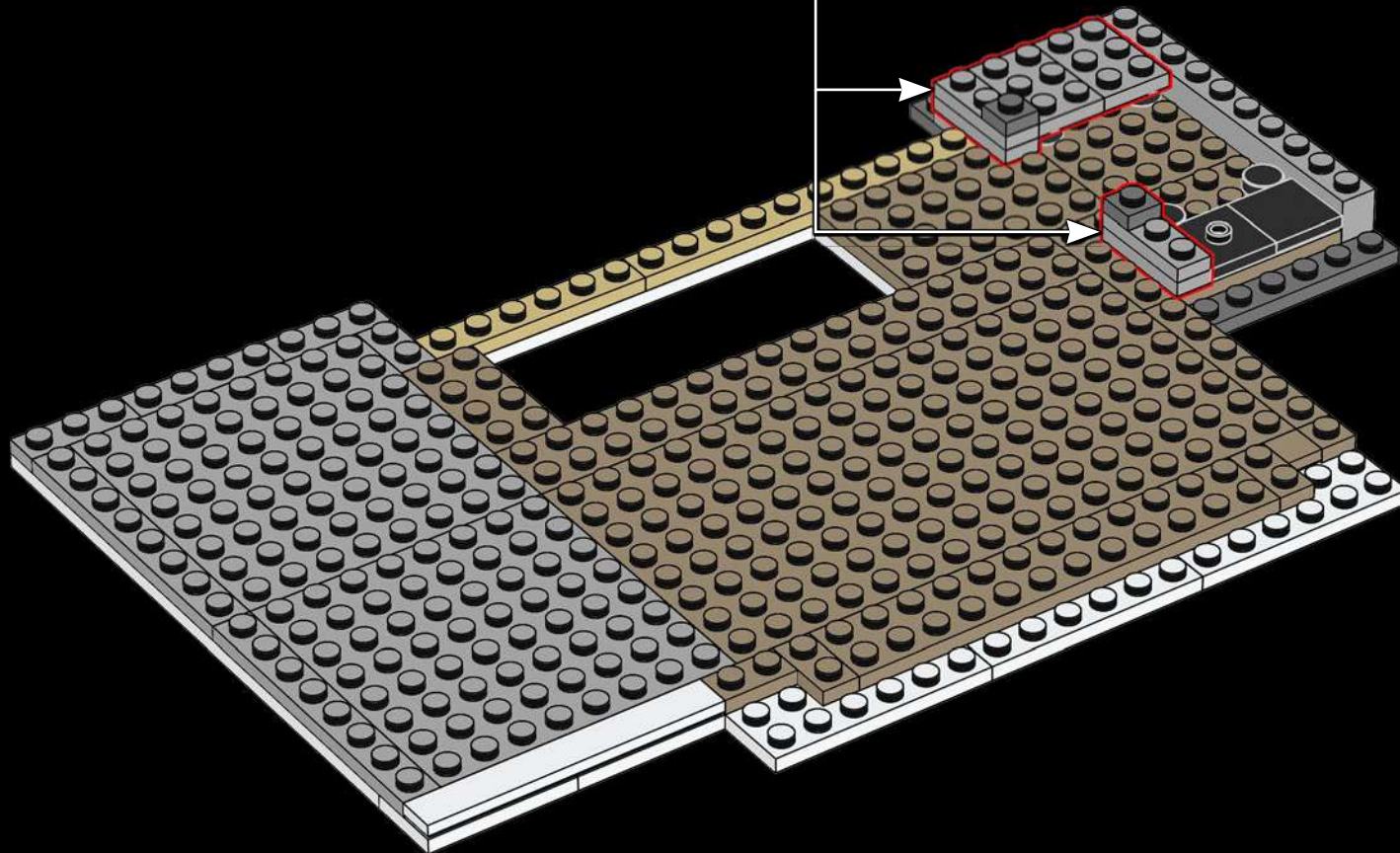
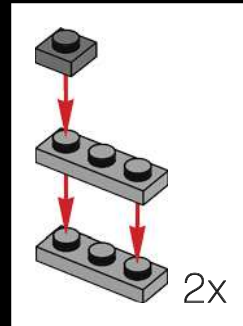

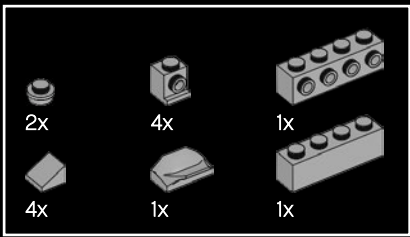

305

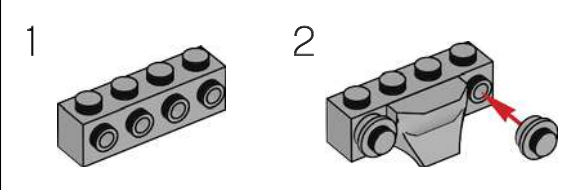
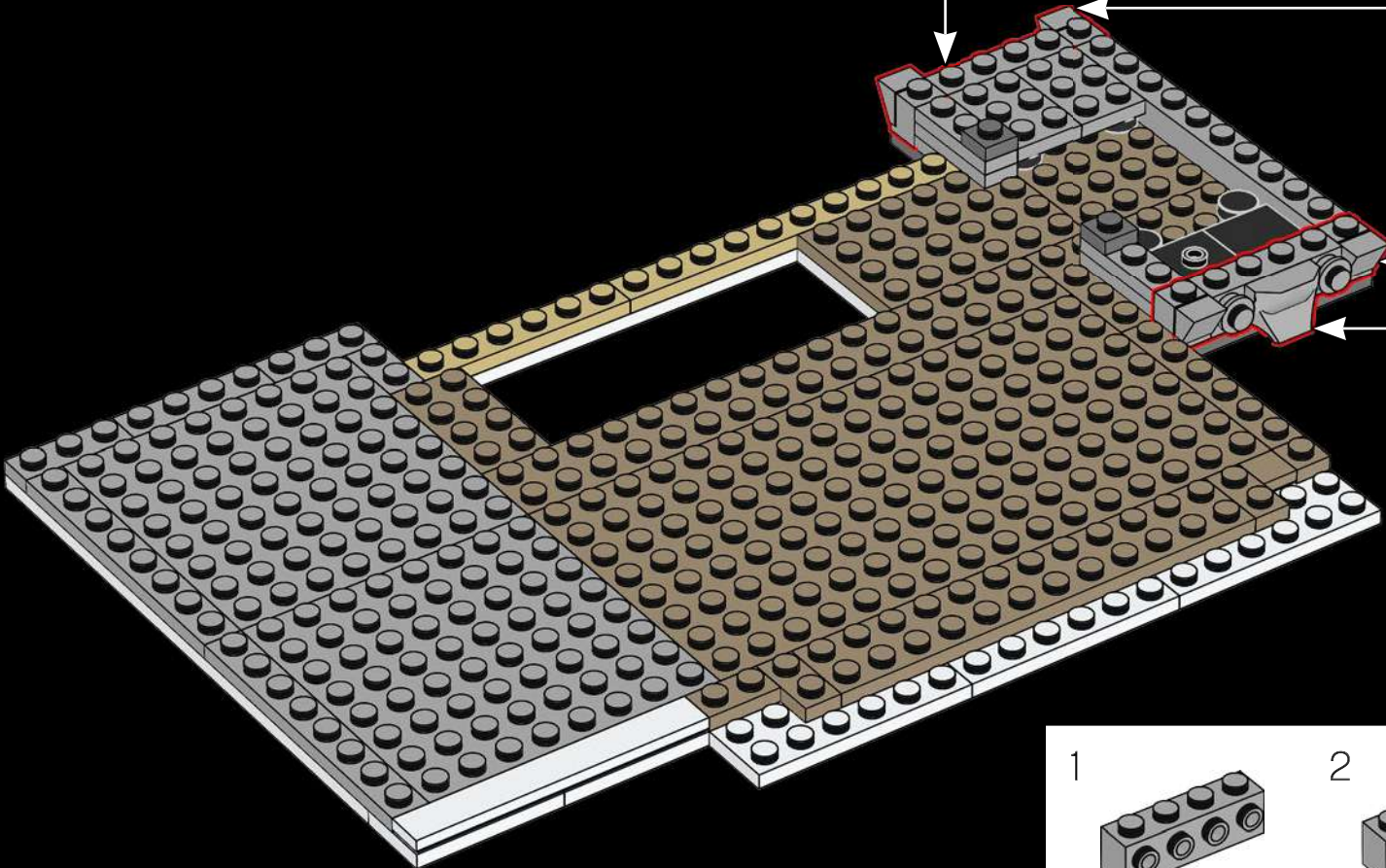
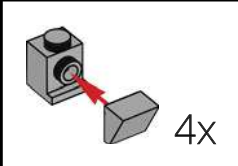
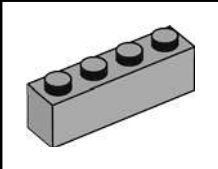

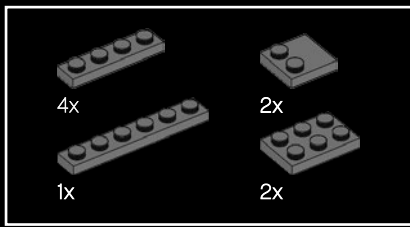

306

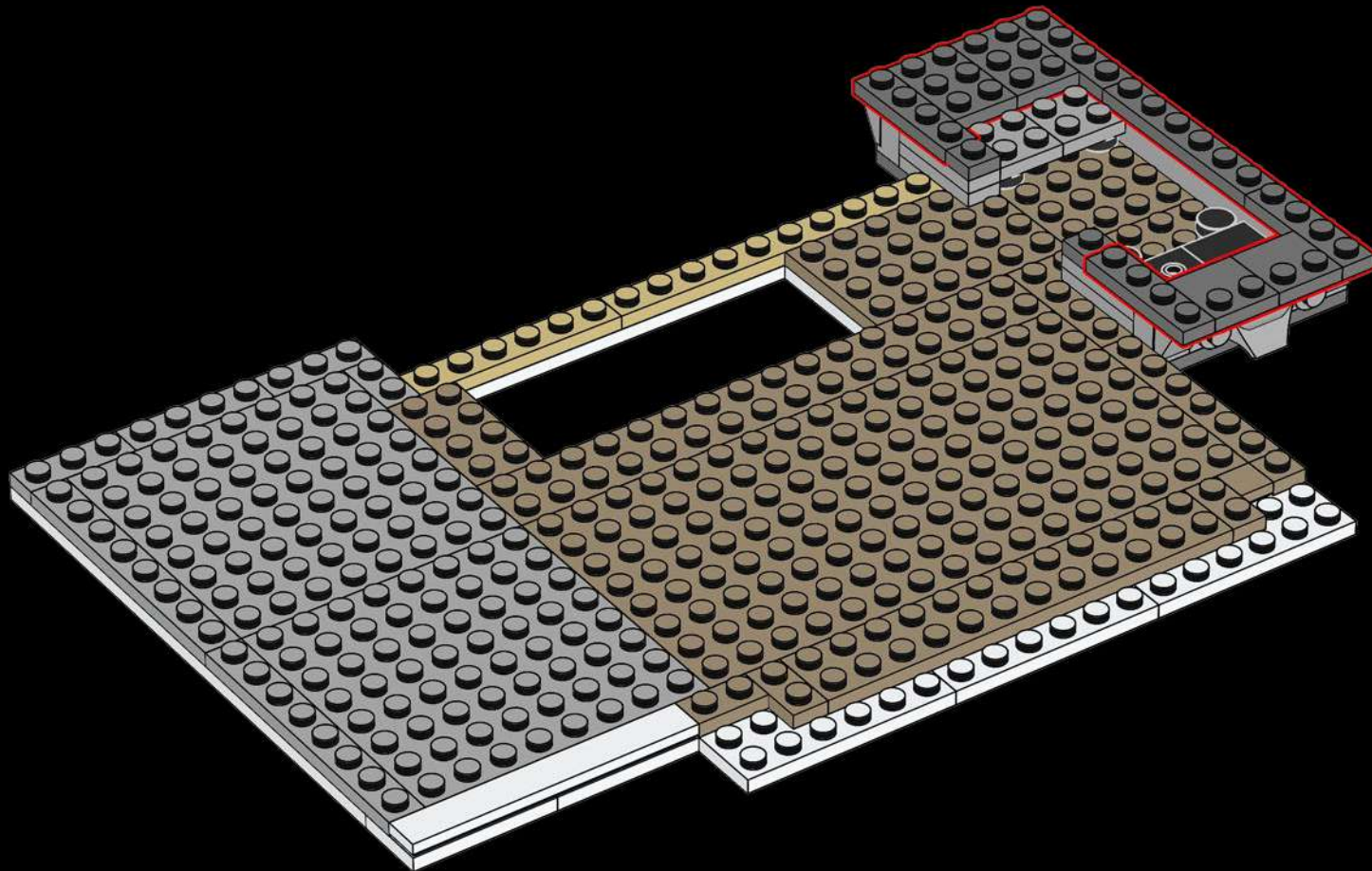

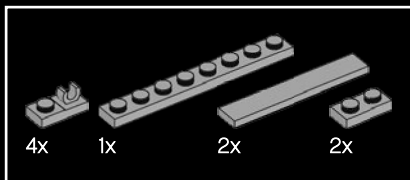

307

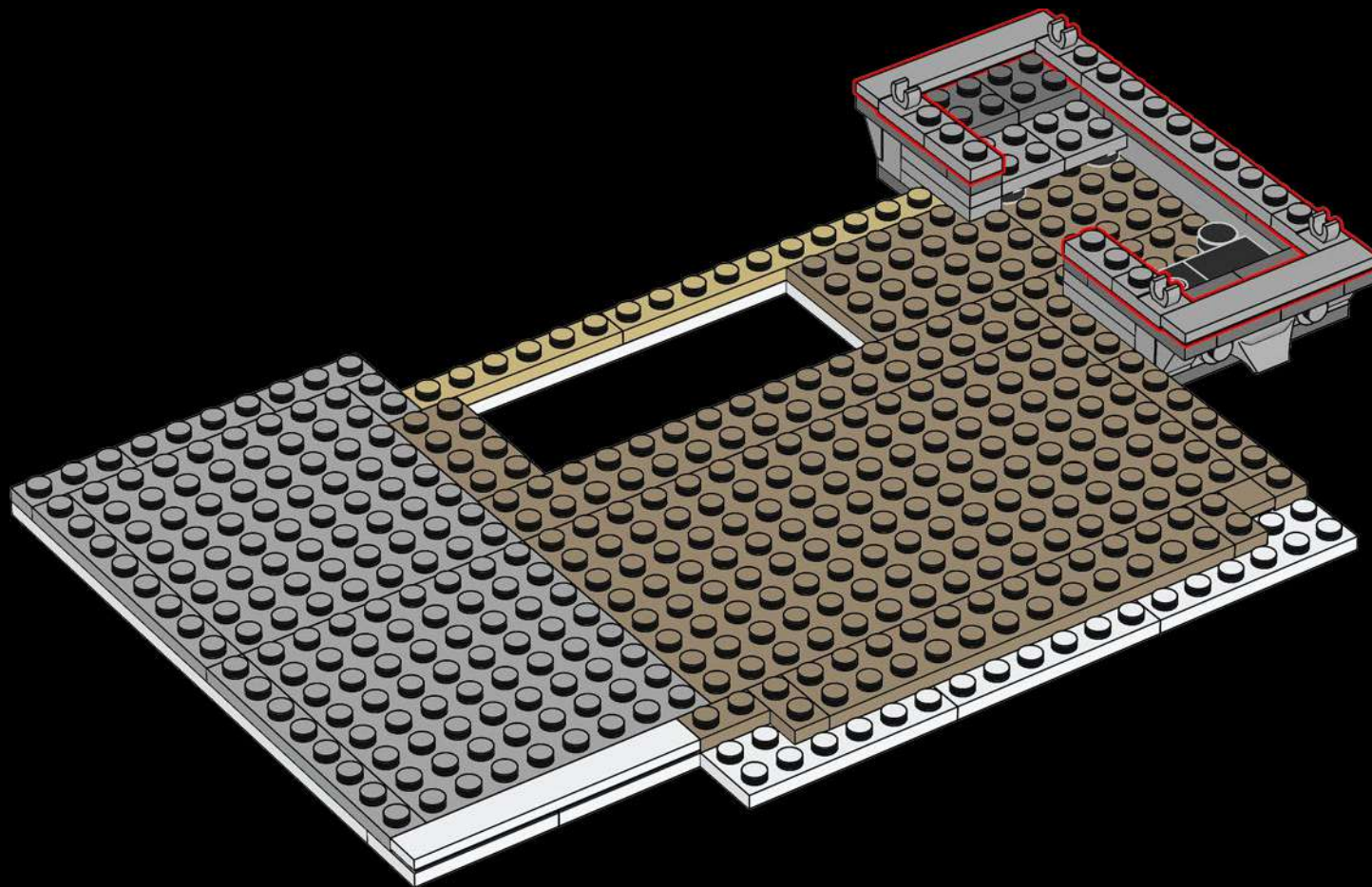

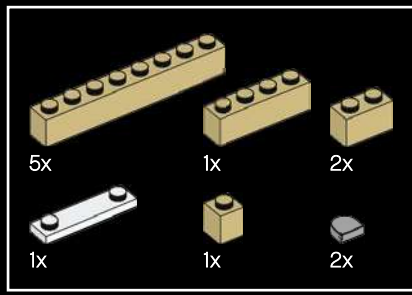

308

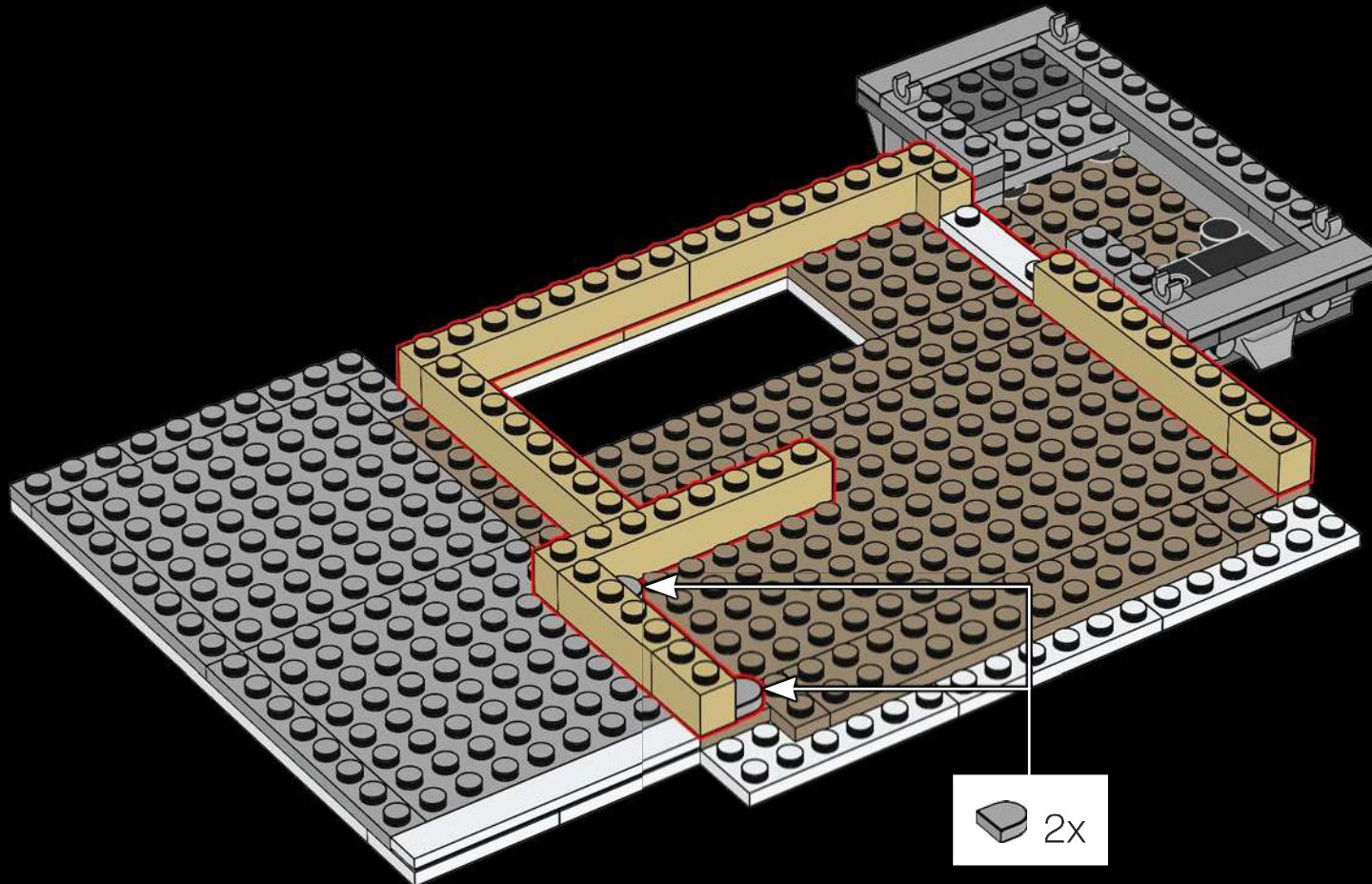

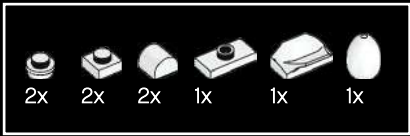

311

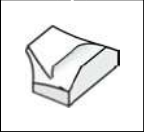
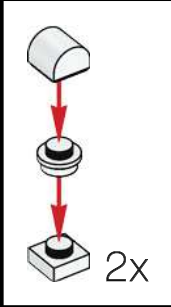
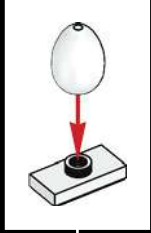
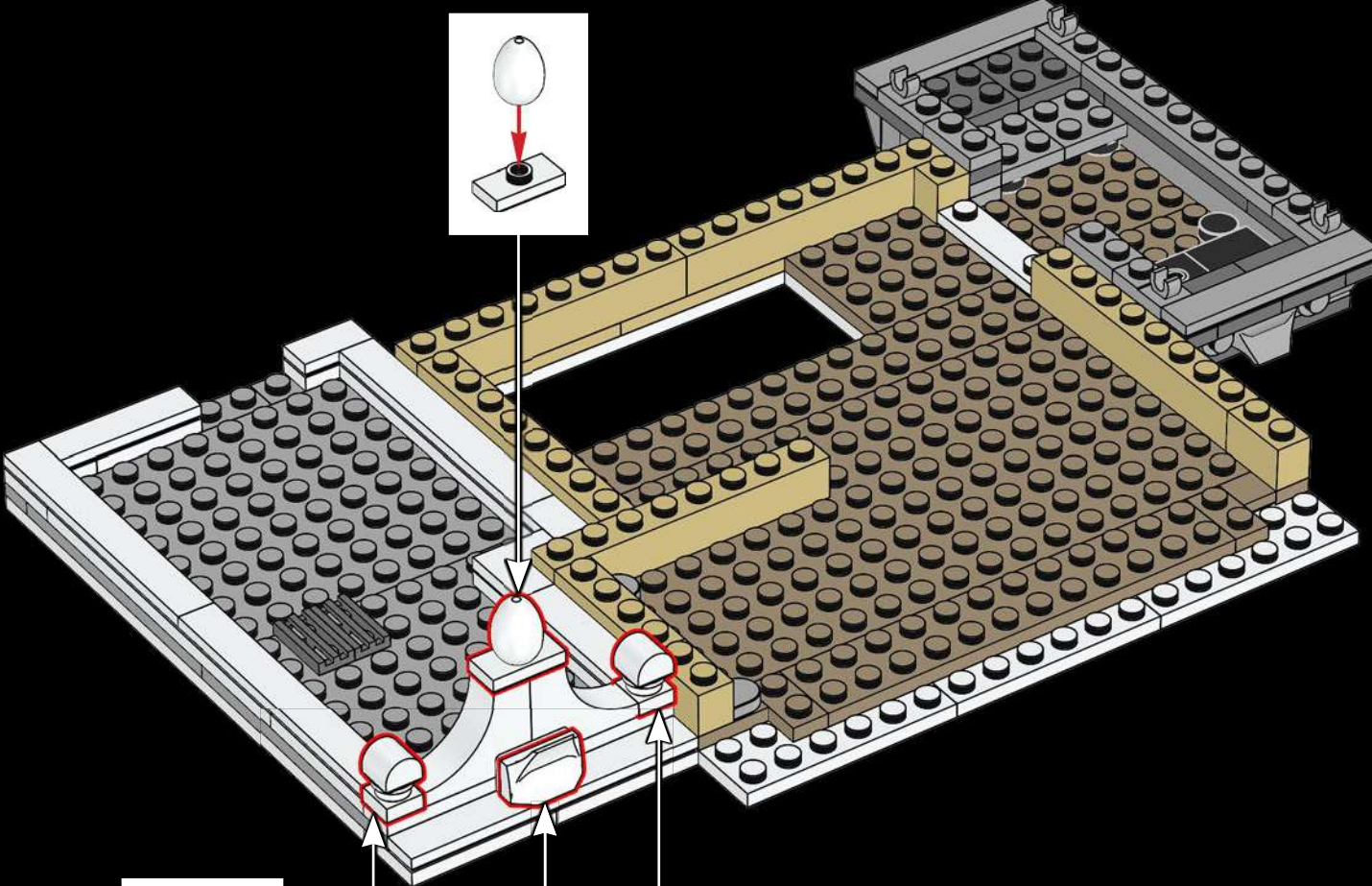



313

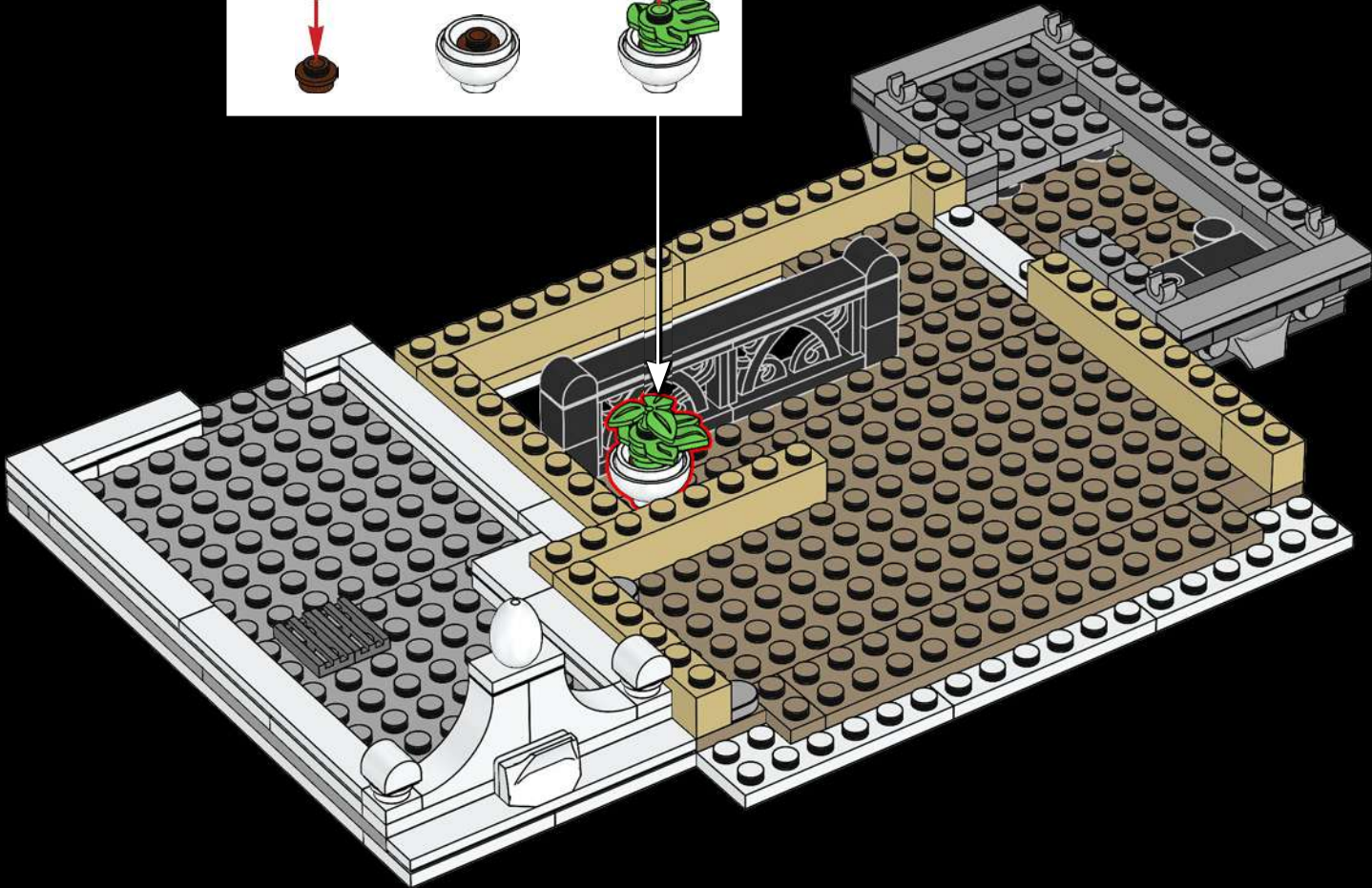
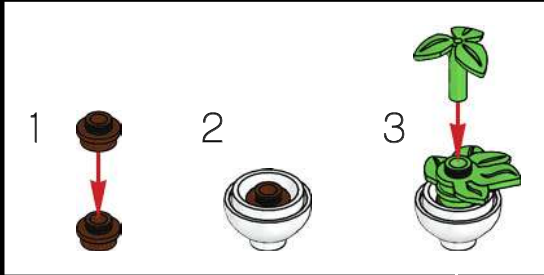

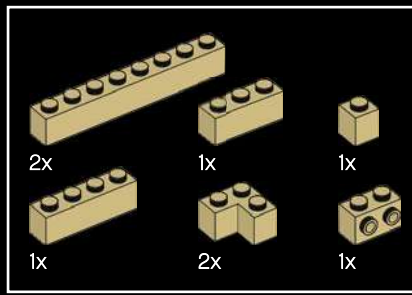

314

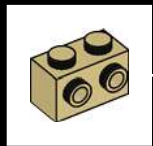
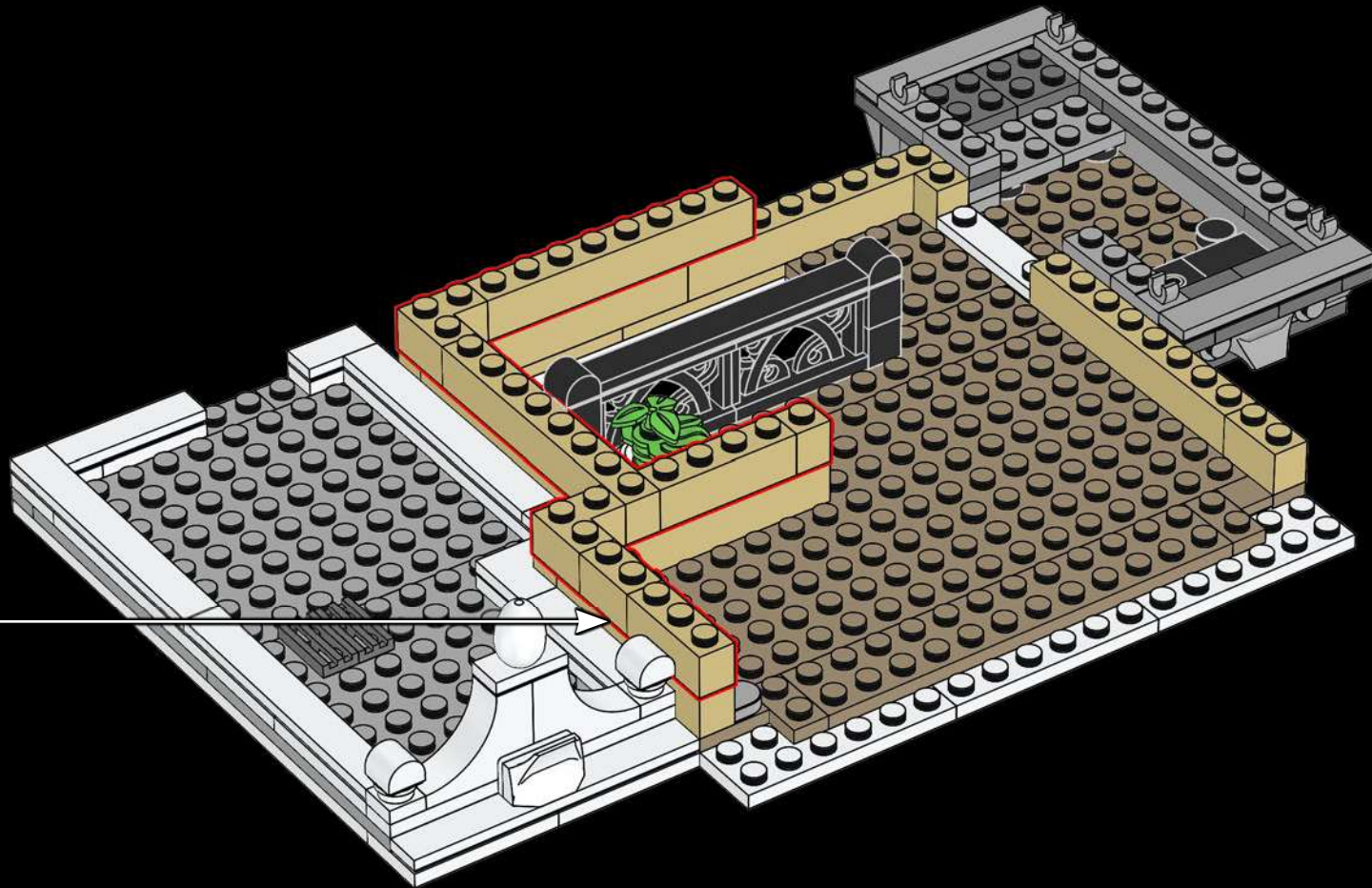

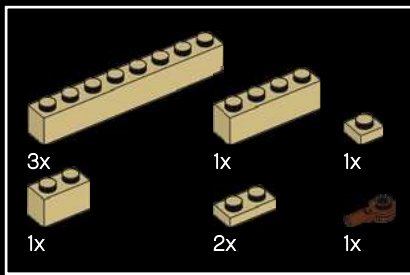

315

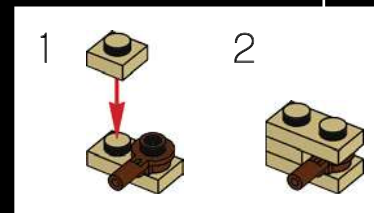
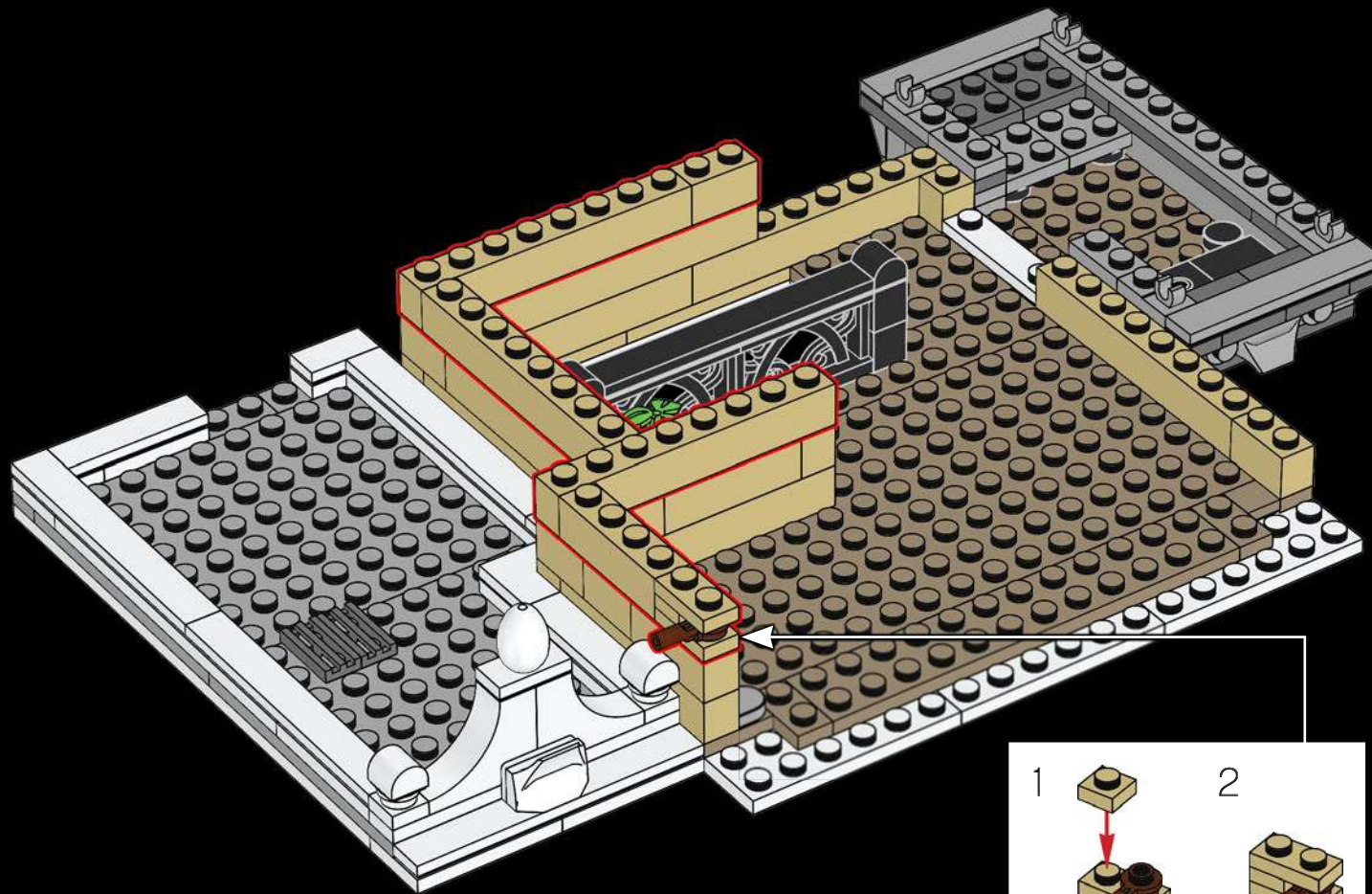

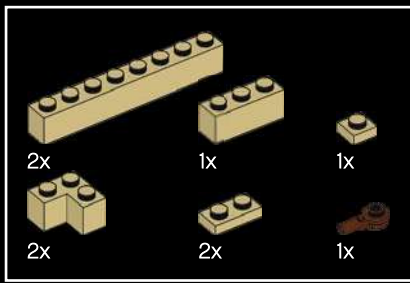

316

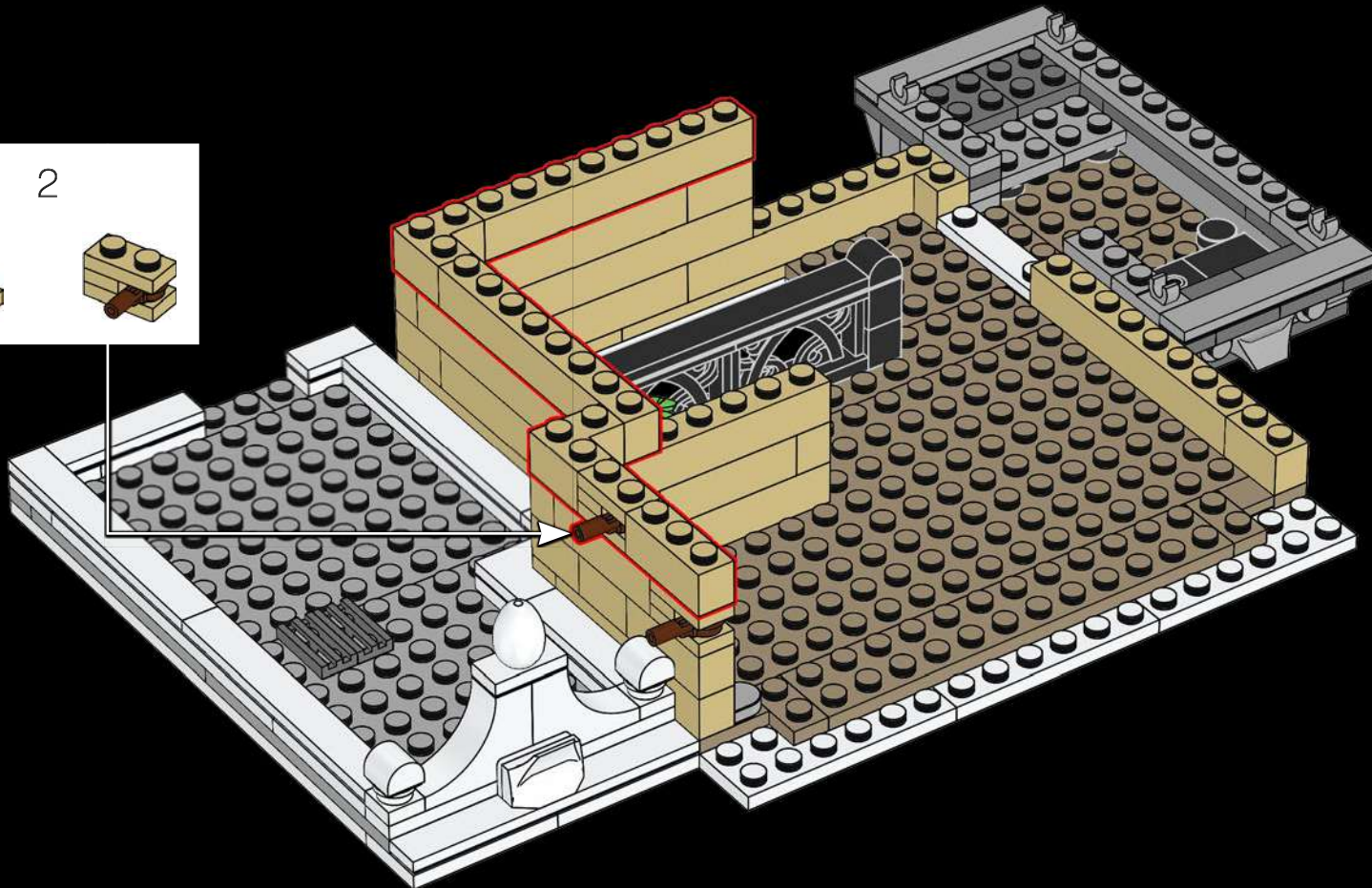
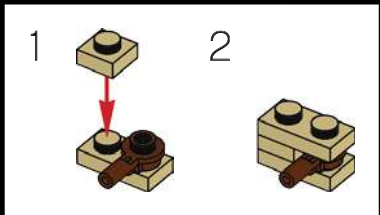

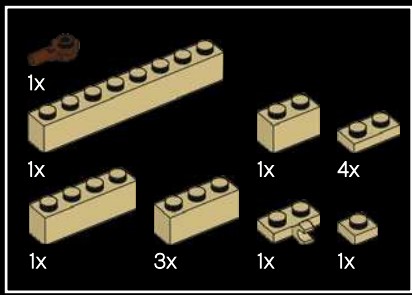

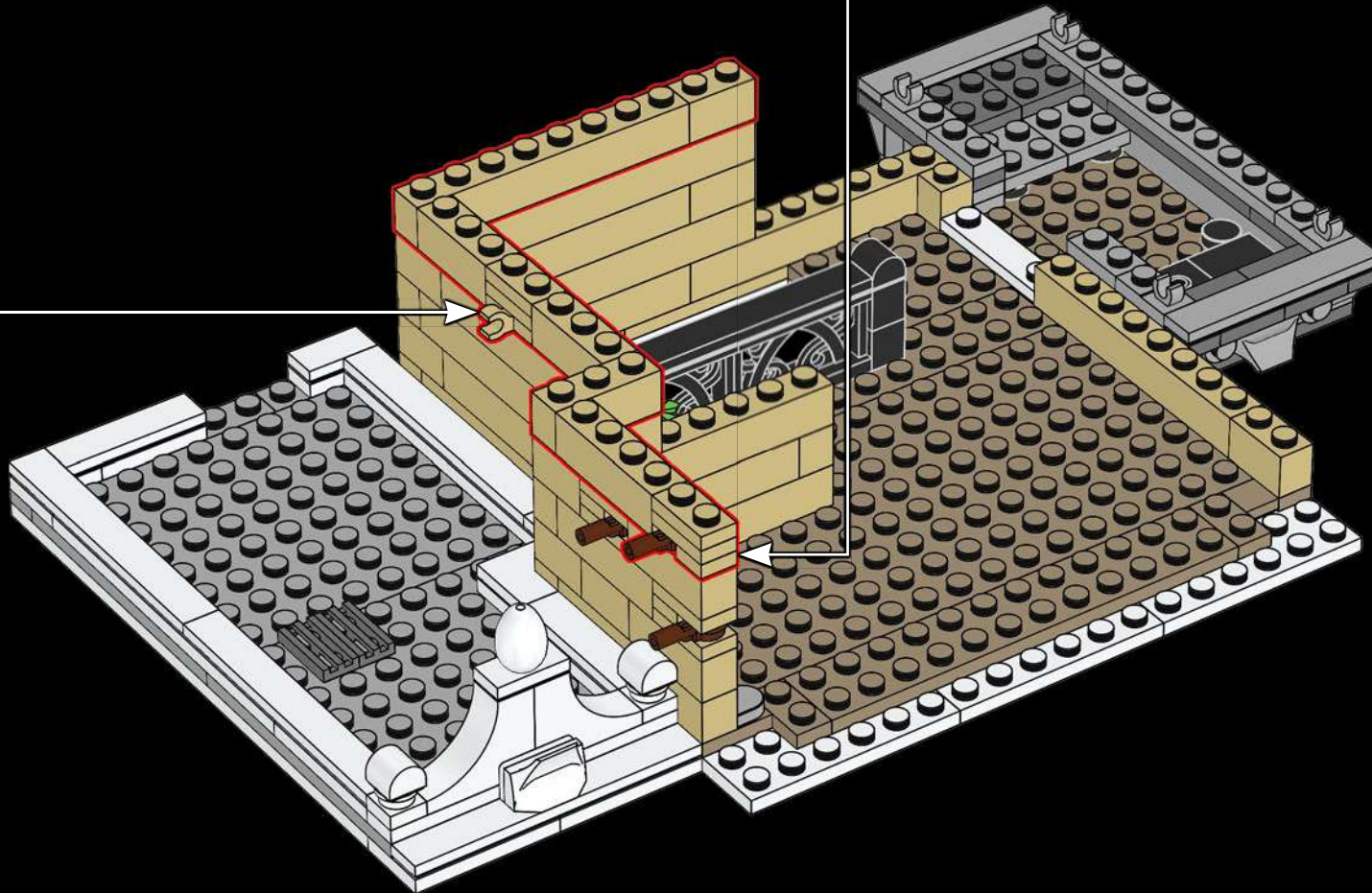
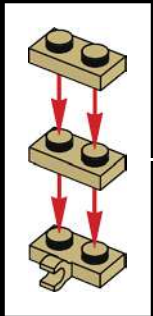
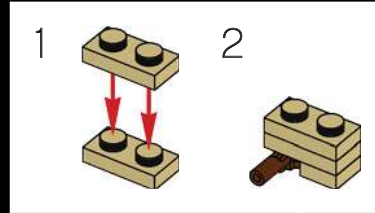

317

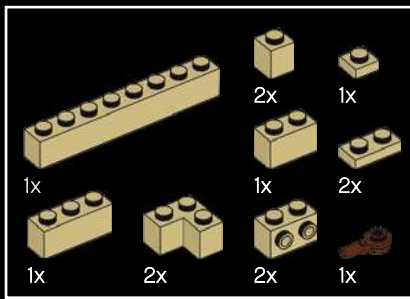

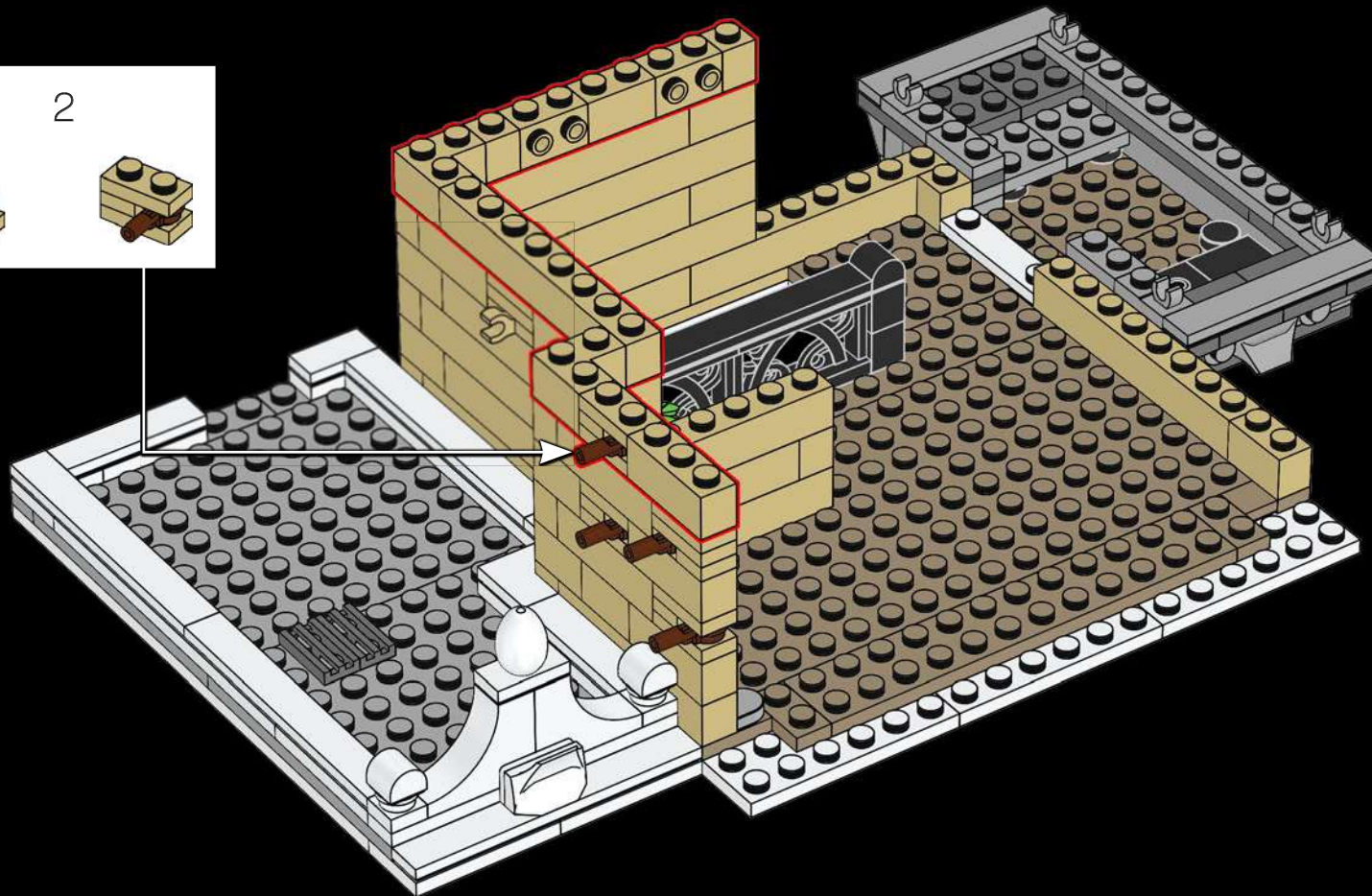
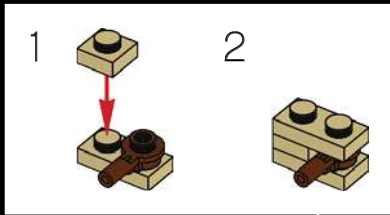

318



	
1x	3x

319

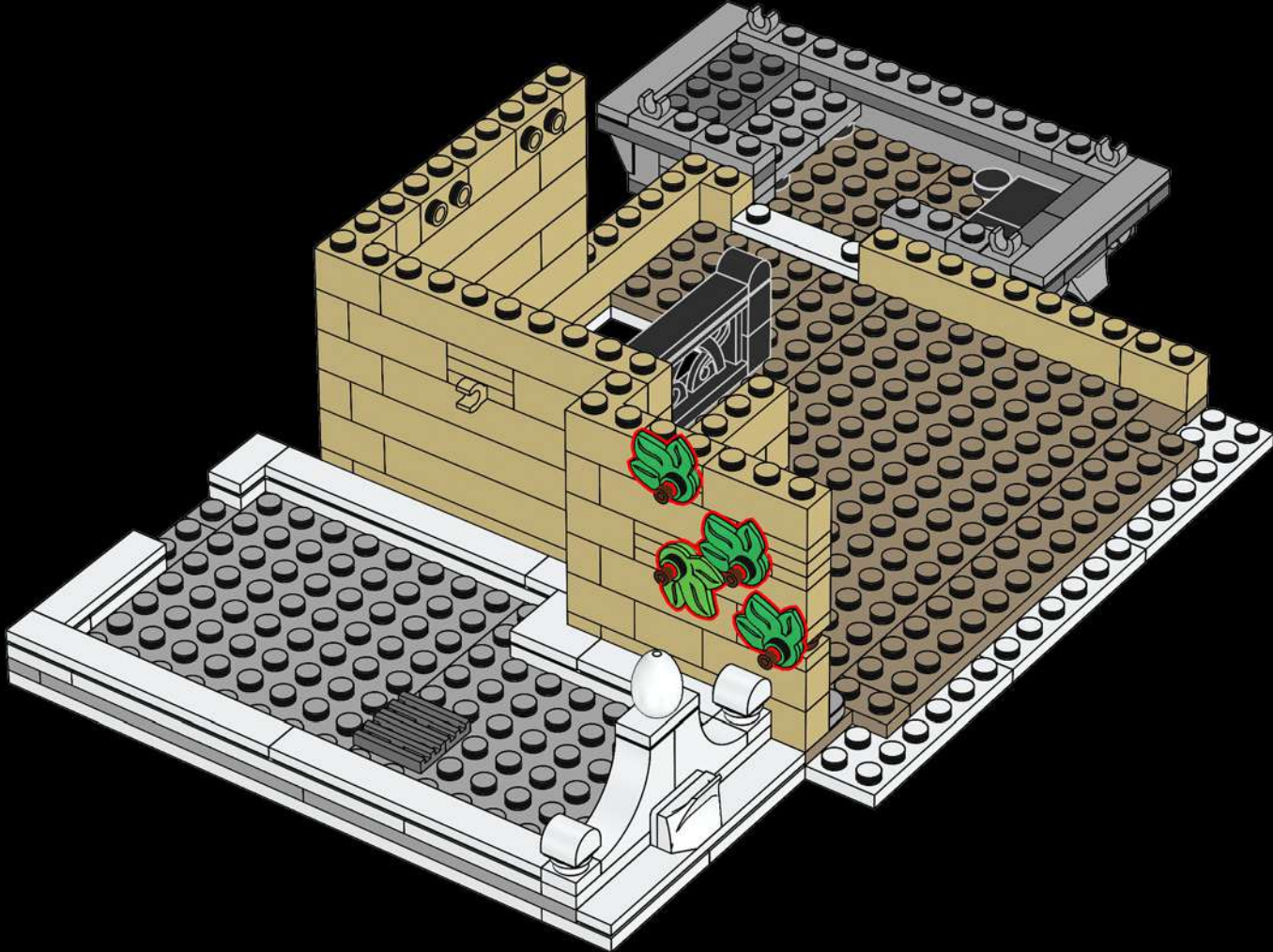



320

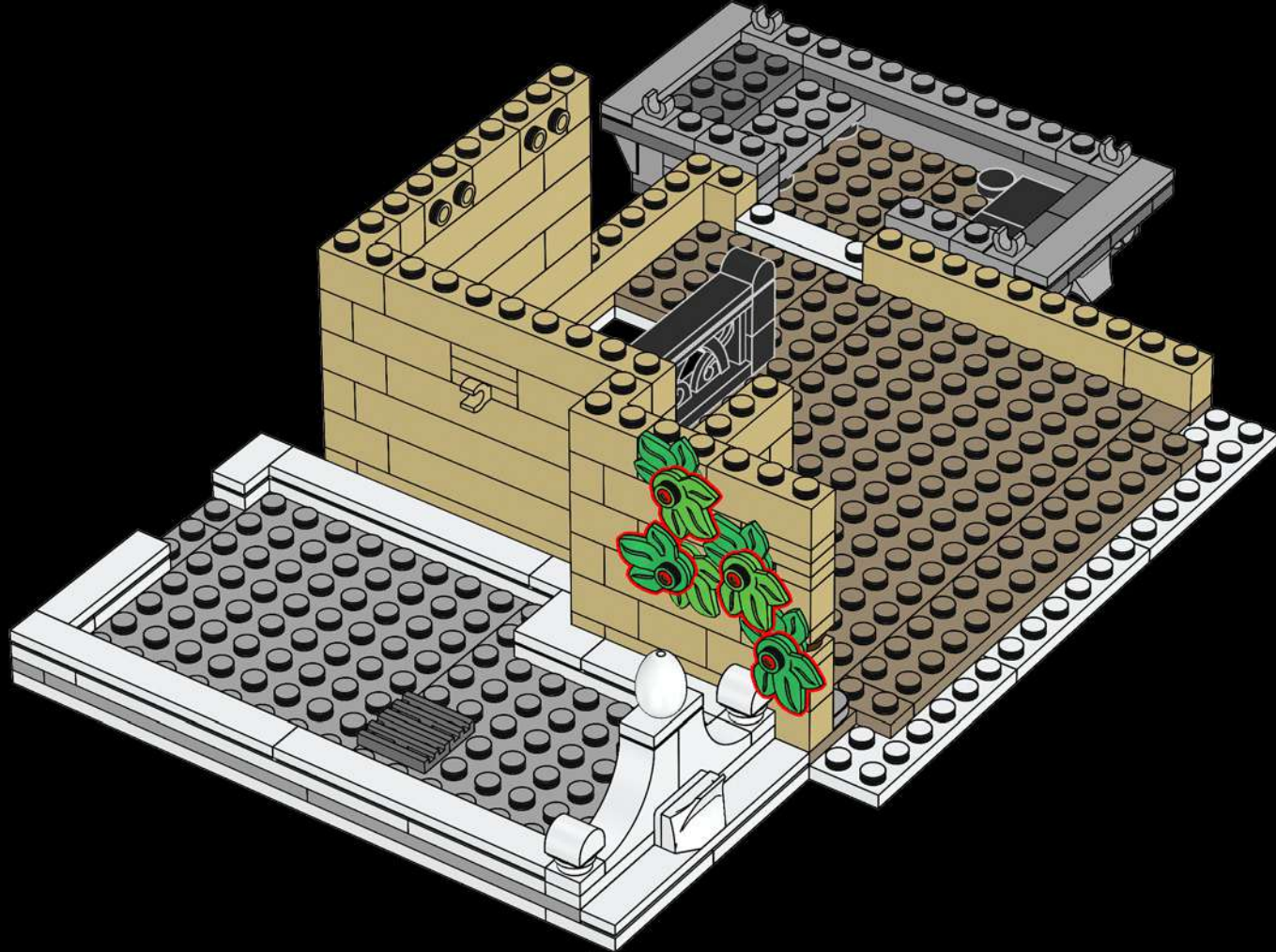

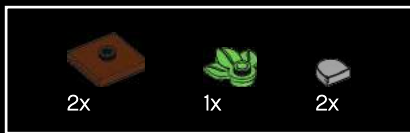

321

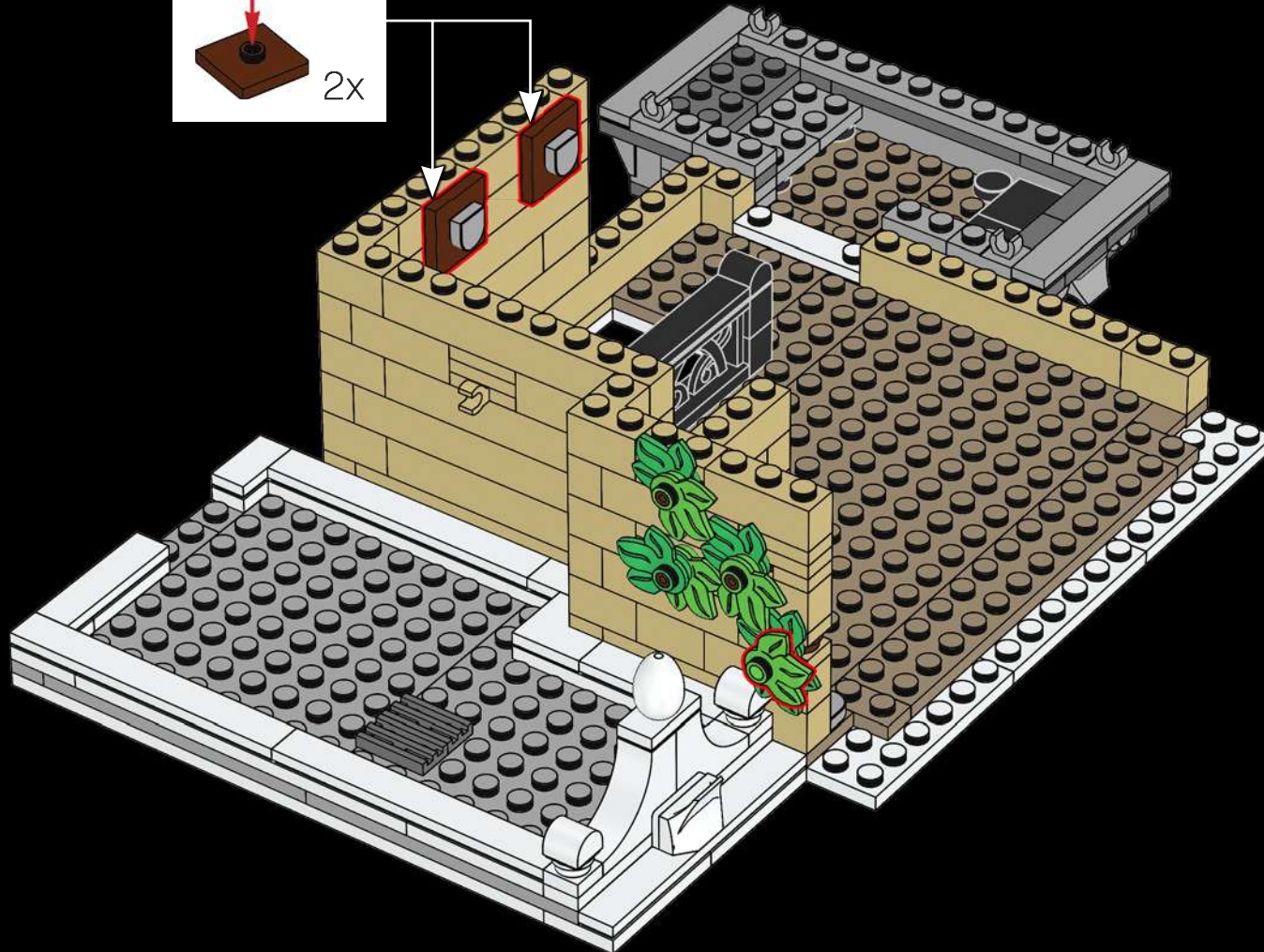
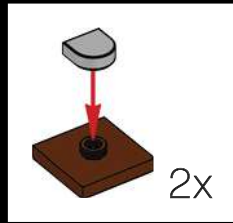

The chief inspector knows every brick of the police station and wants to take a bite out of crime.

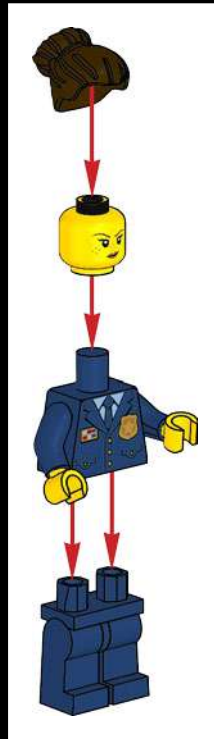

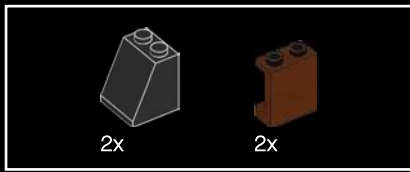

323





324

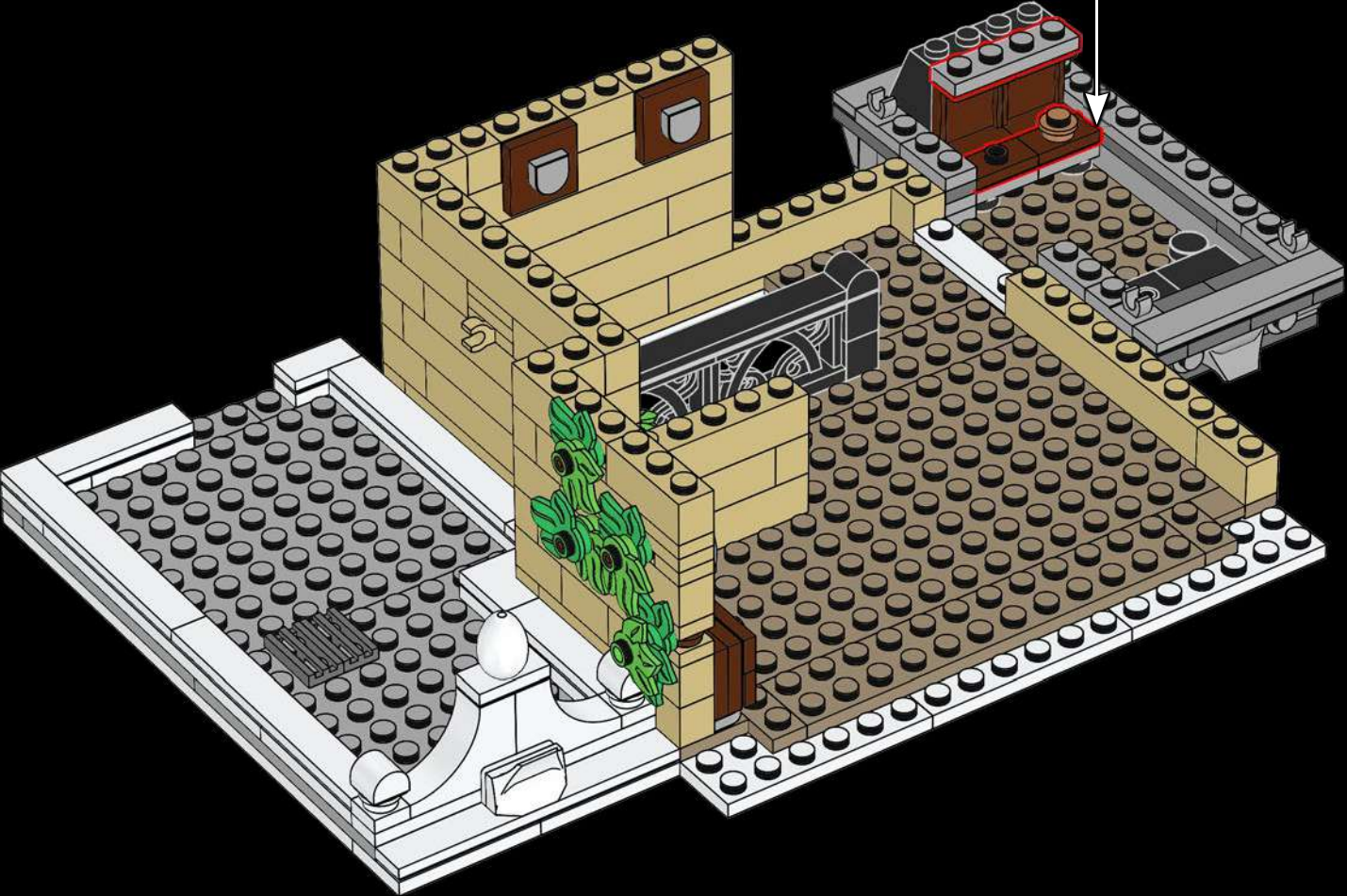



325

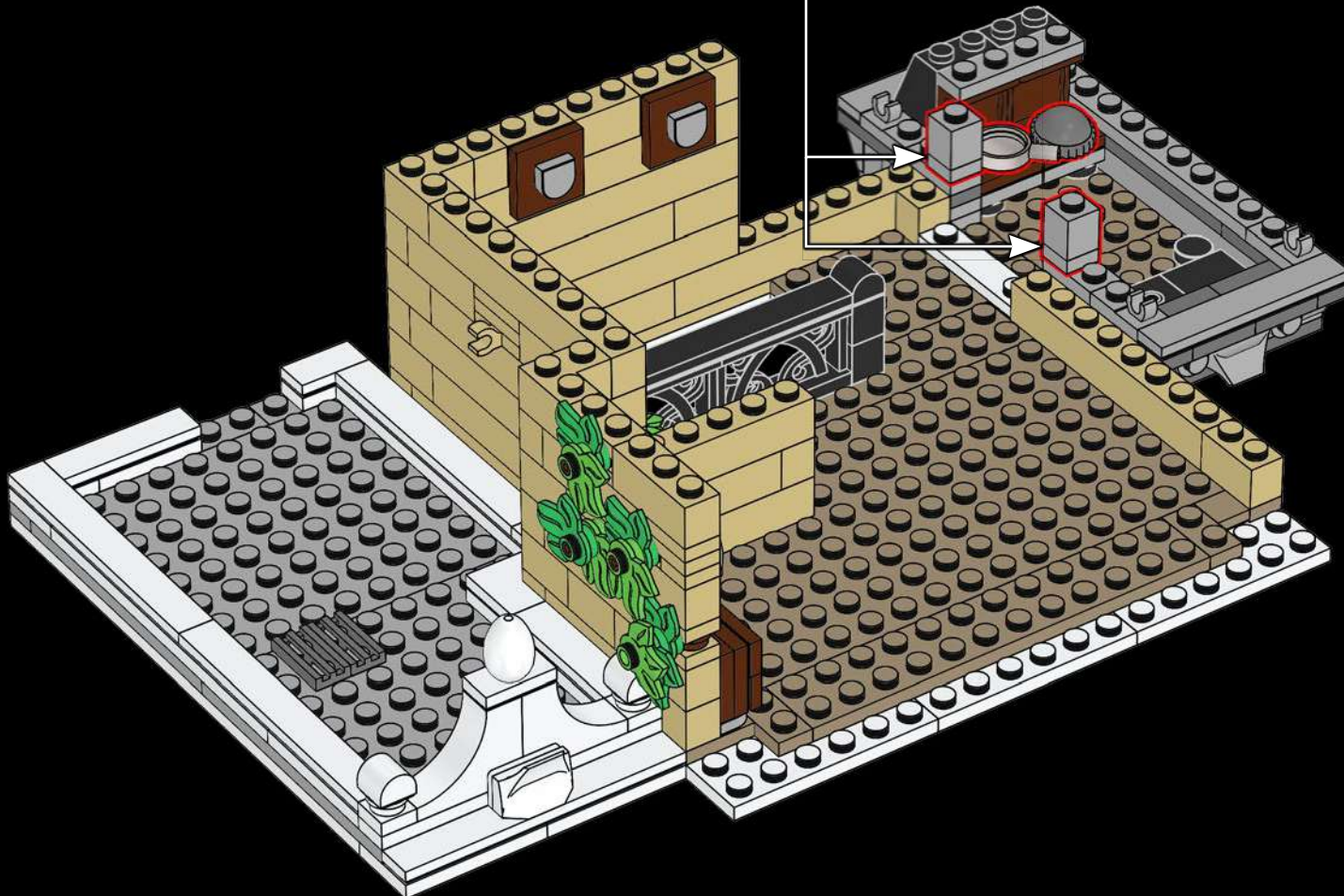
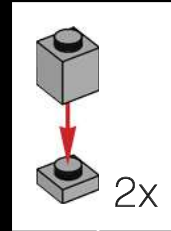

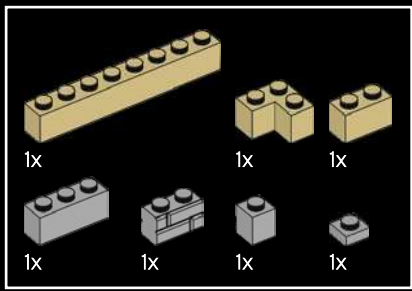

326

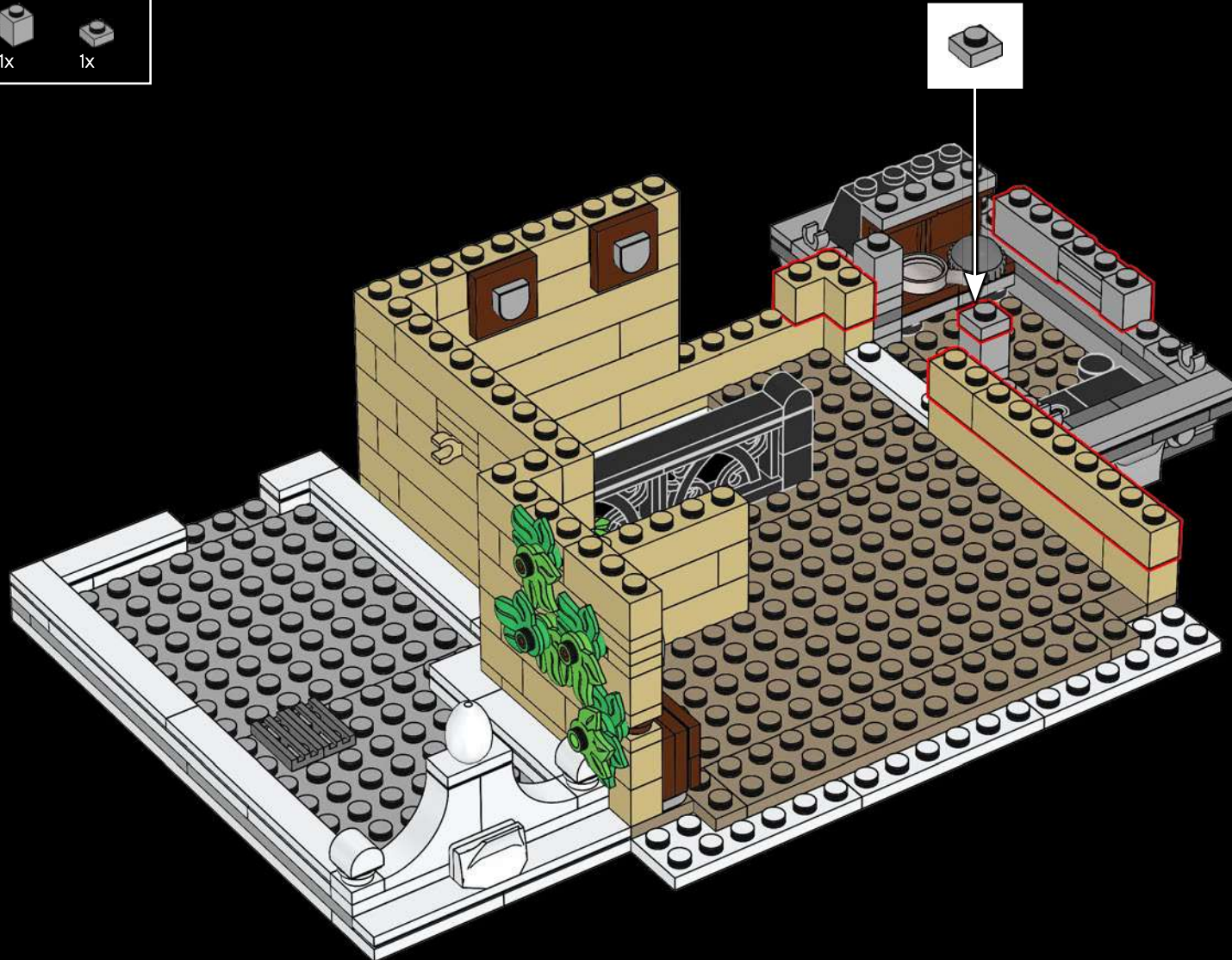

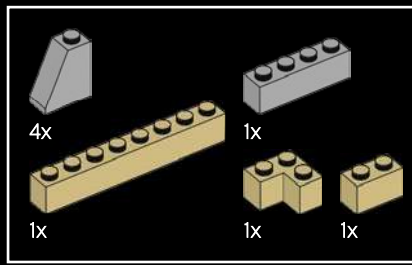

327

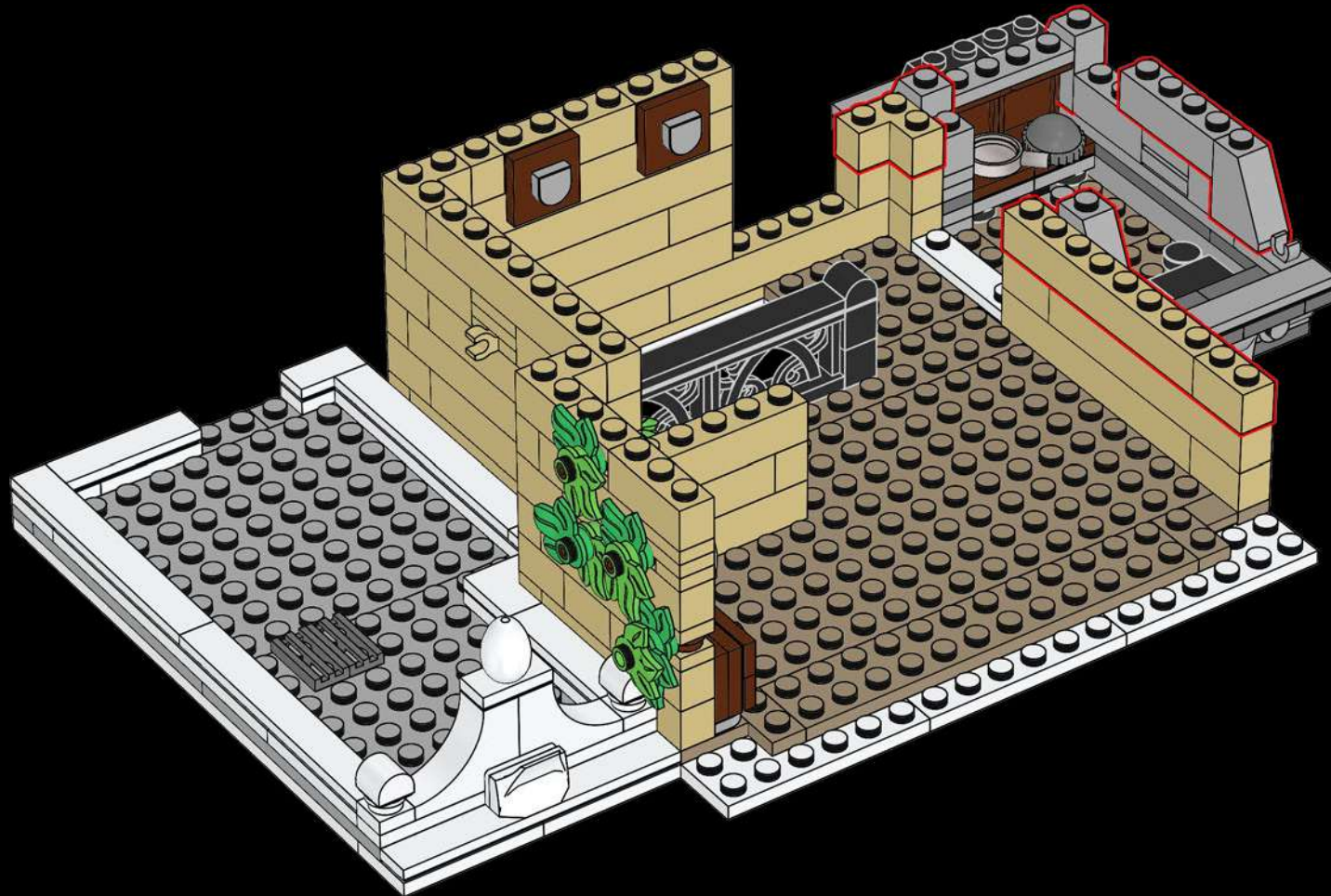

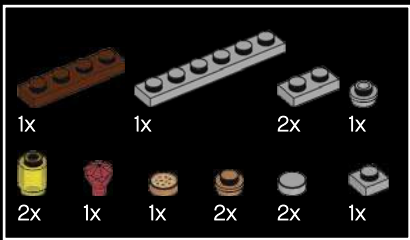

328

1

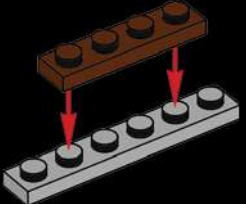

2

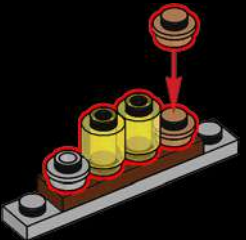

3



4



5

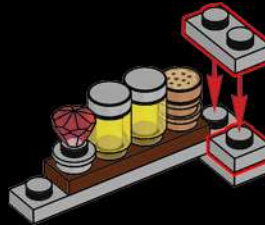



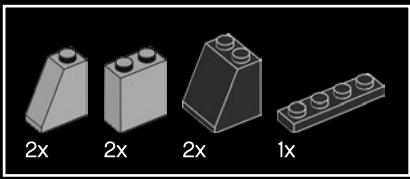

329

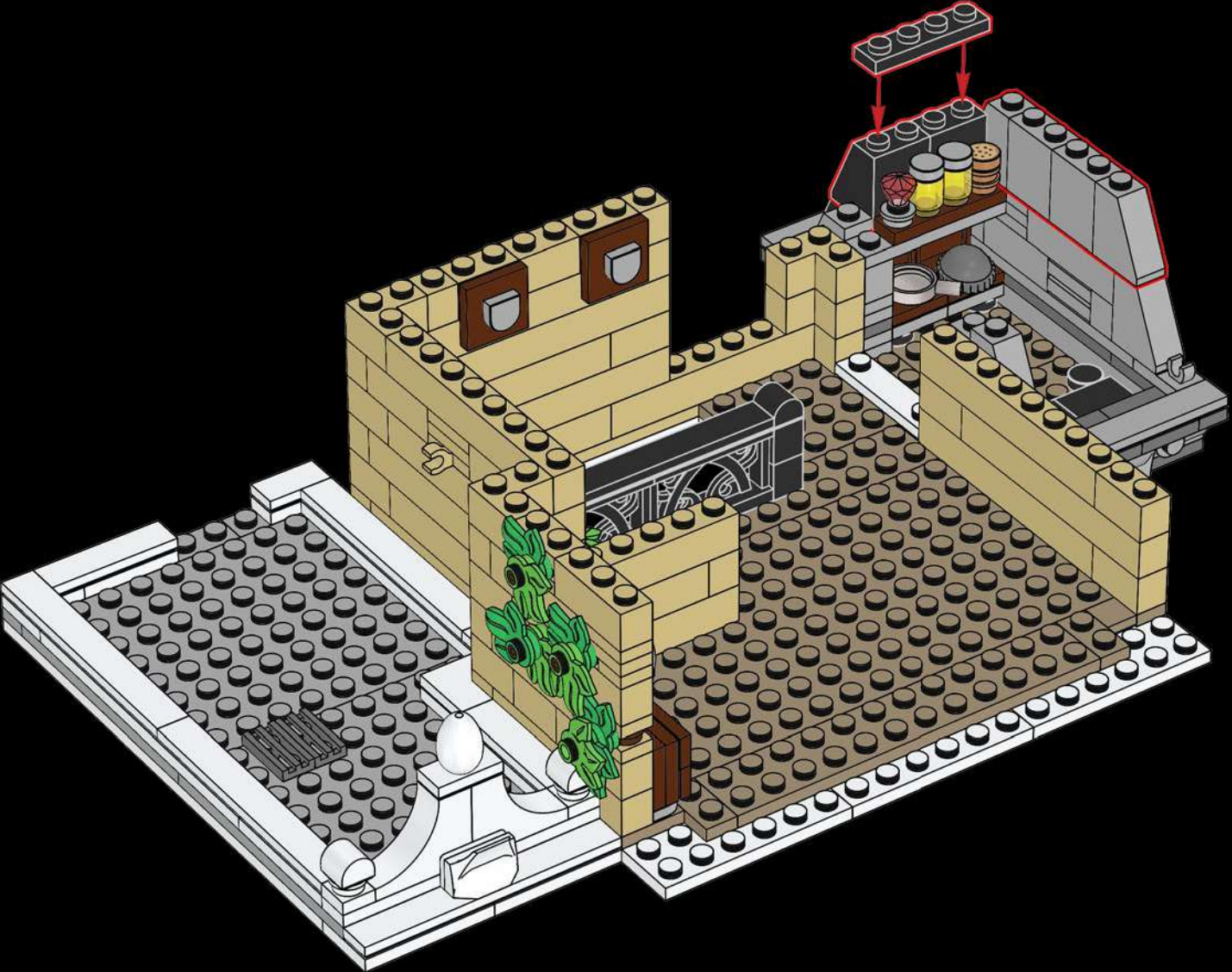

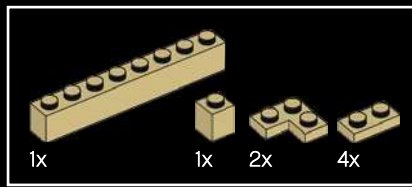

330

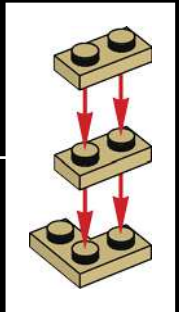
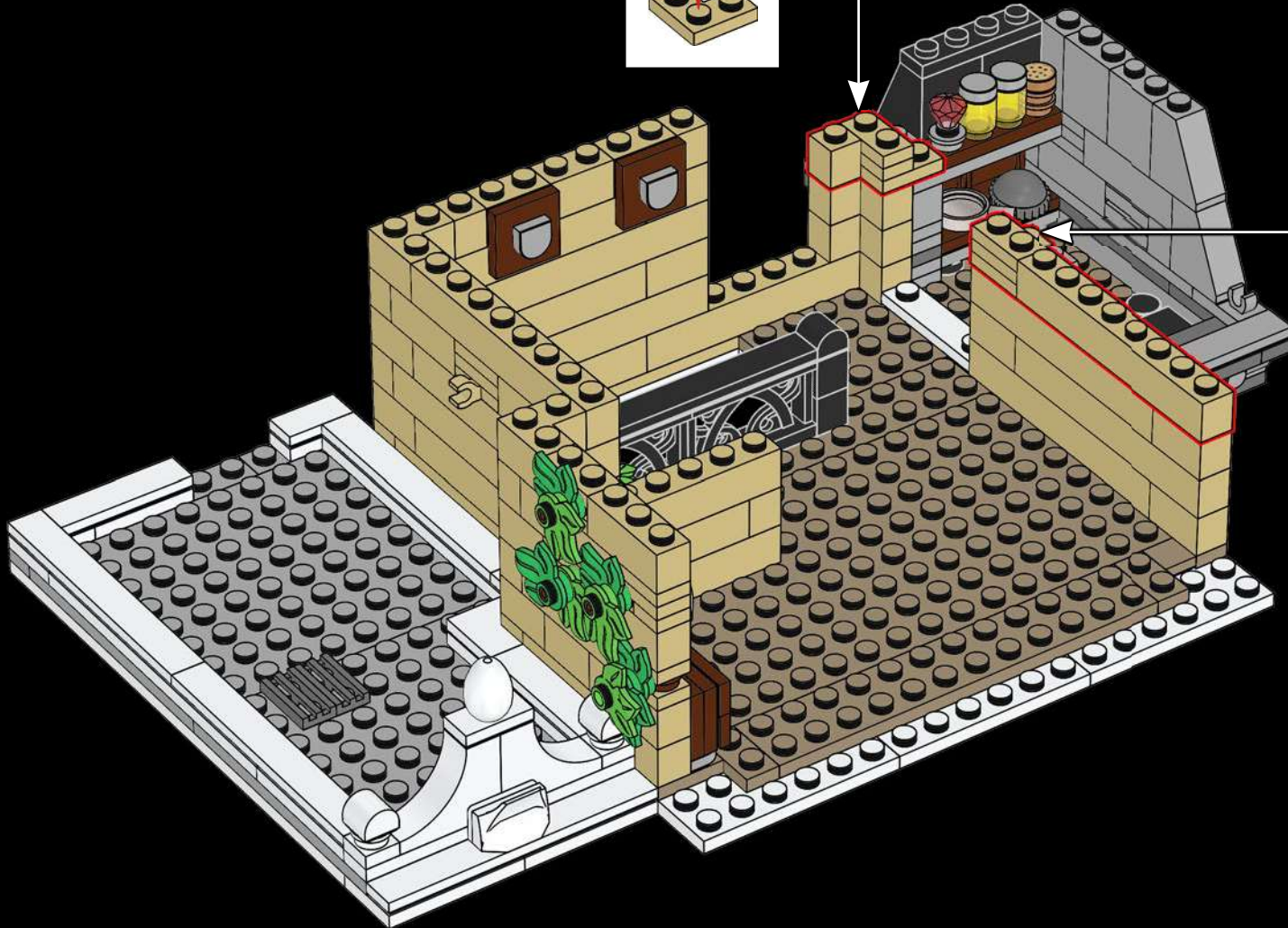
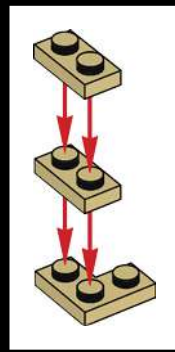

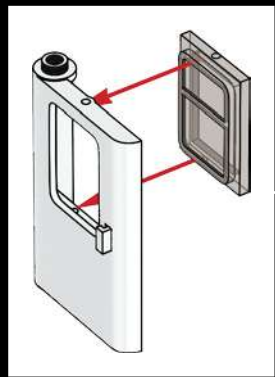
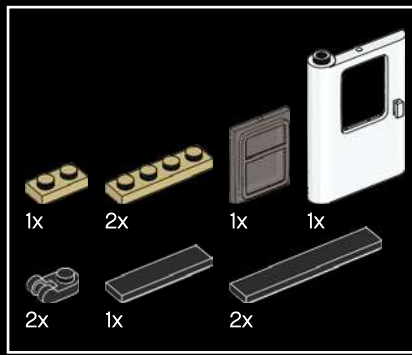

332

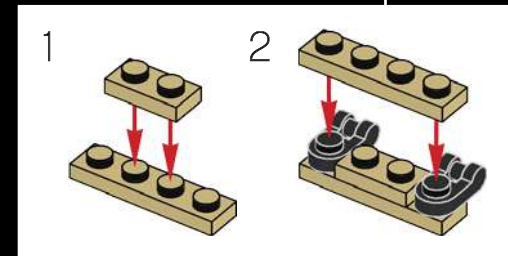
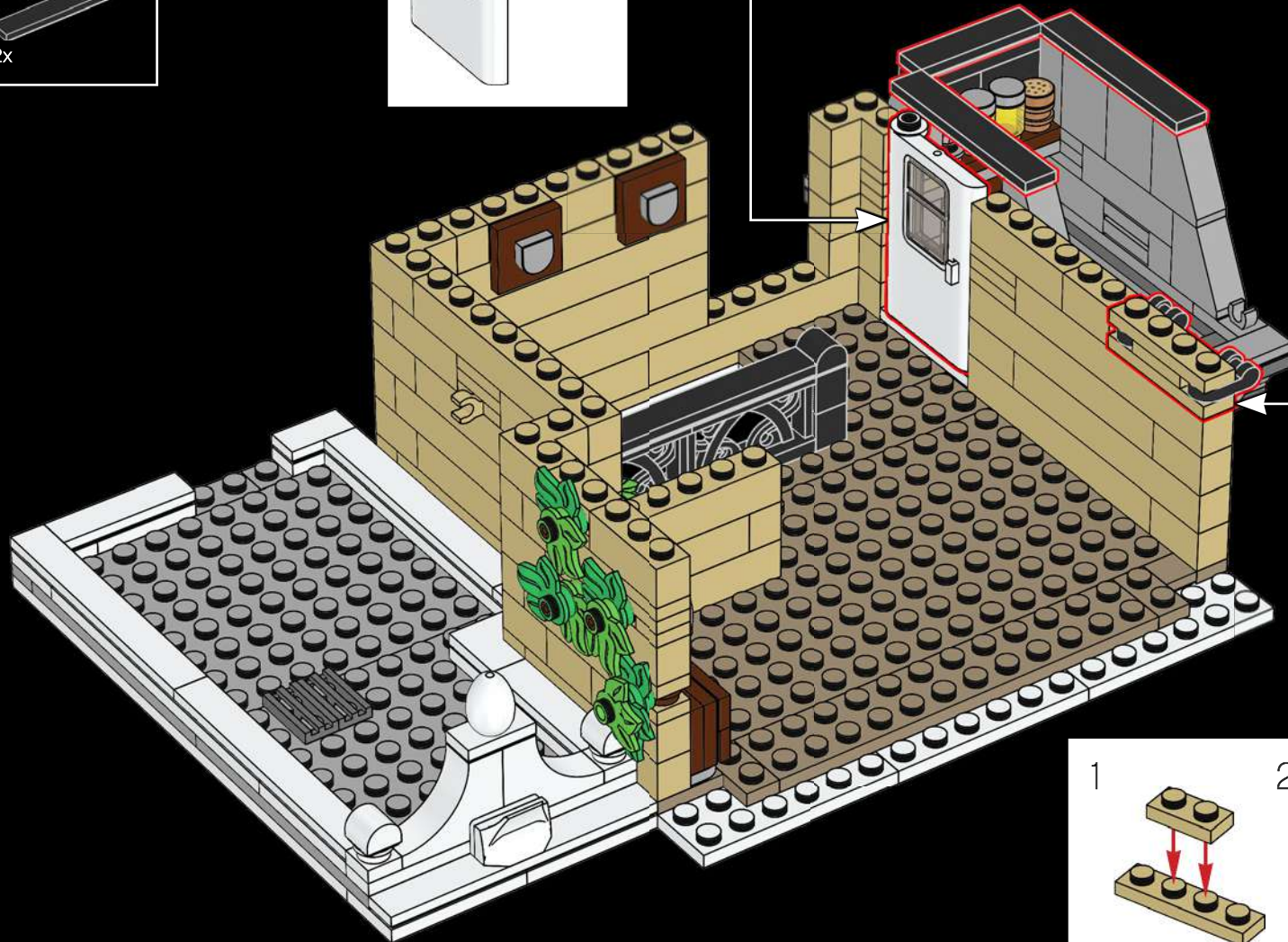

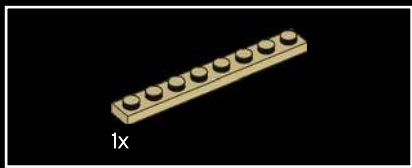

333

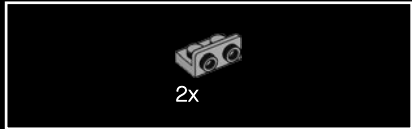
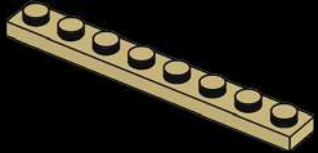

334

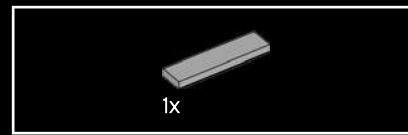
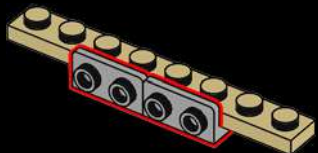

335

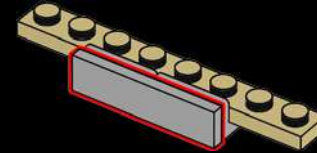

336

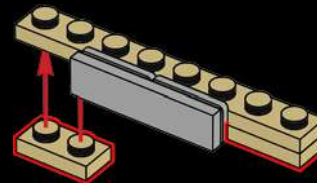

337

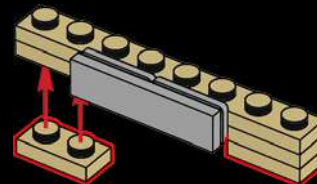

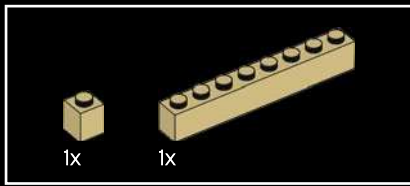

338



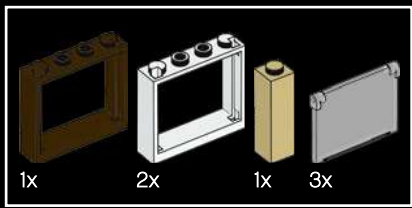

339

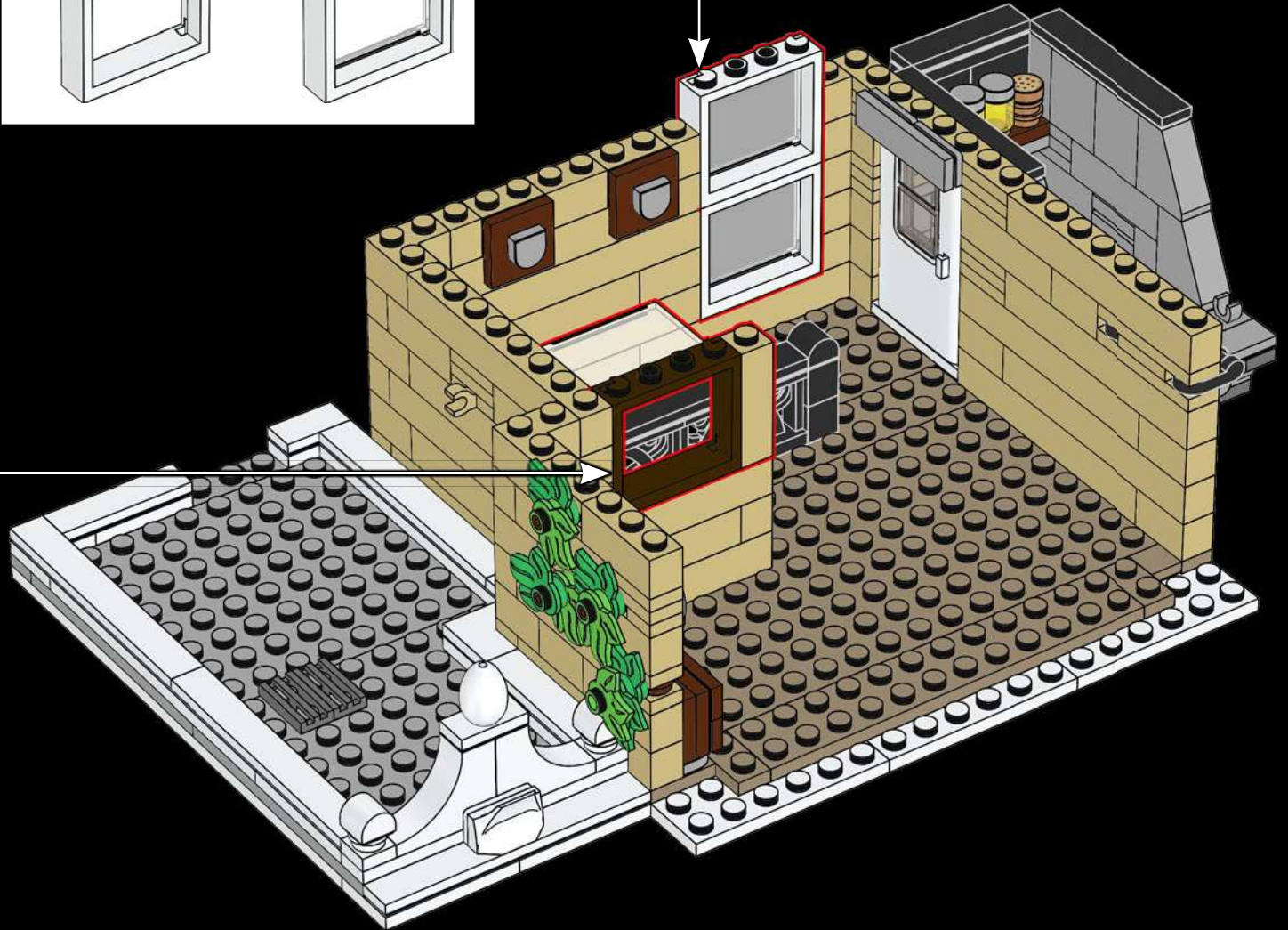
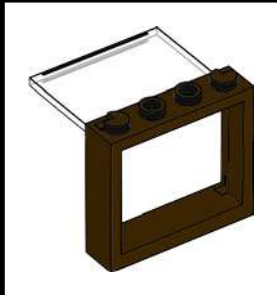
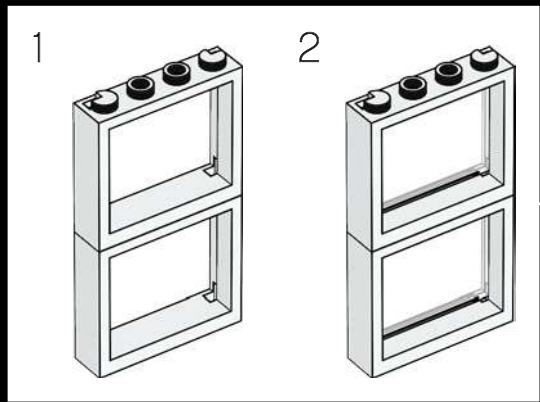



340



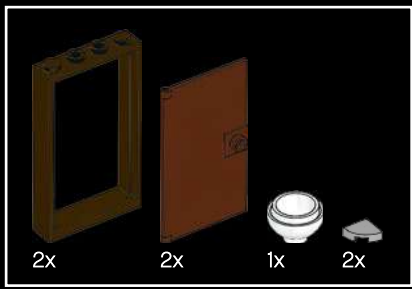

341

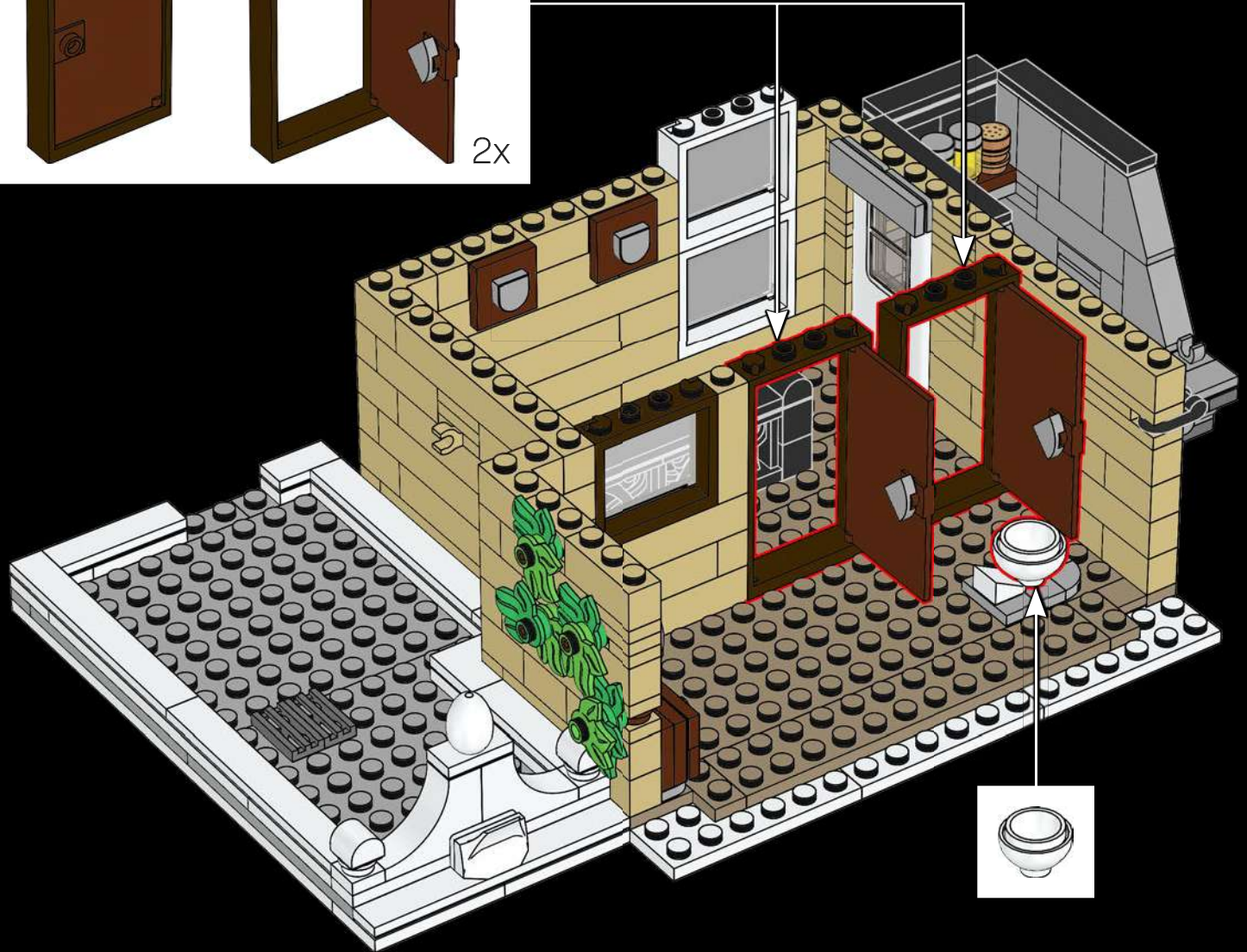
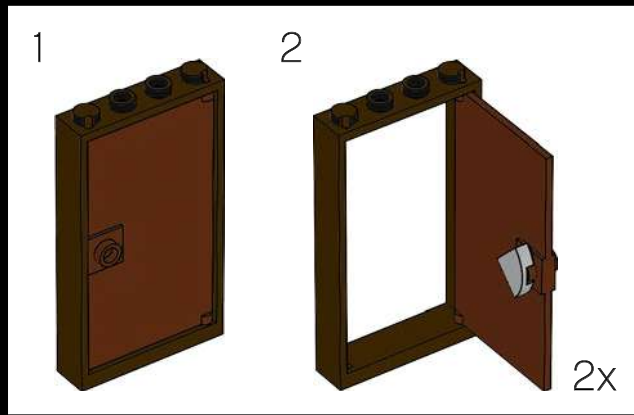

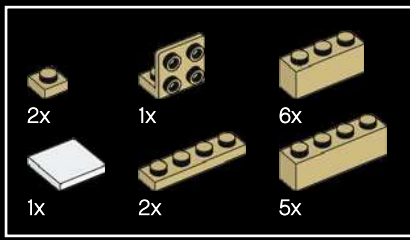

342

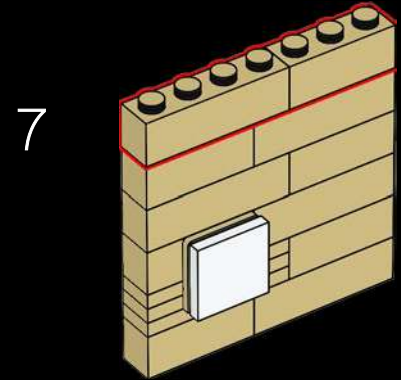
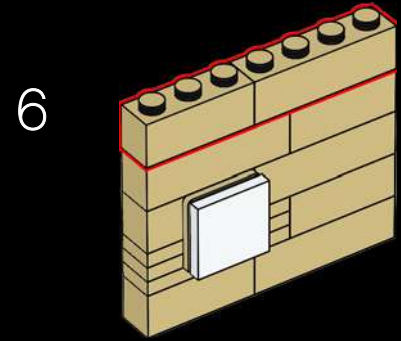
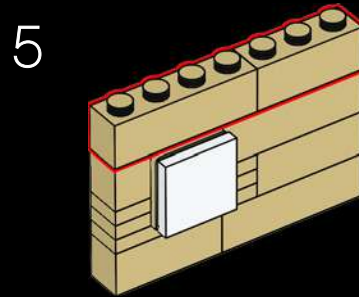
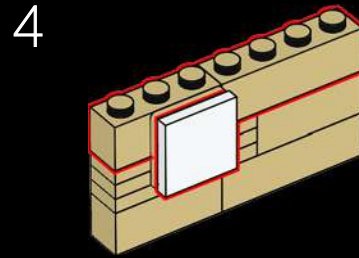
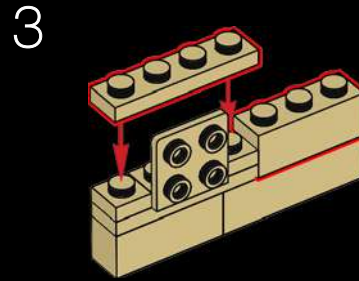
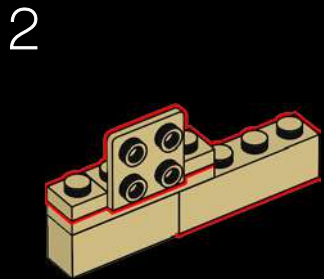
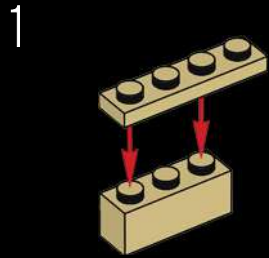

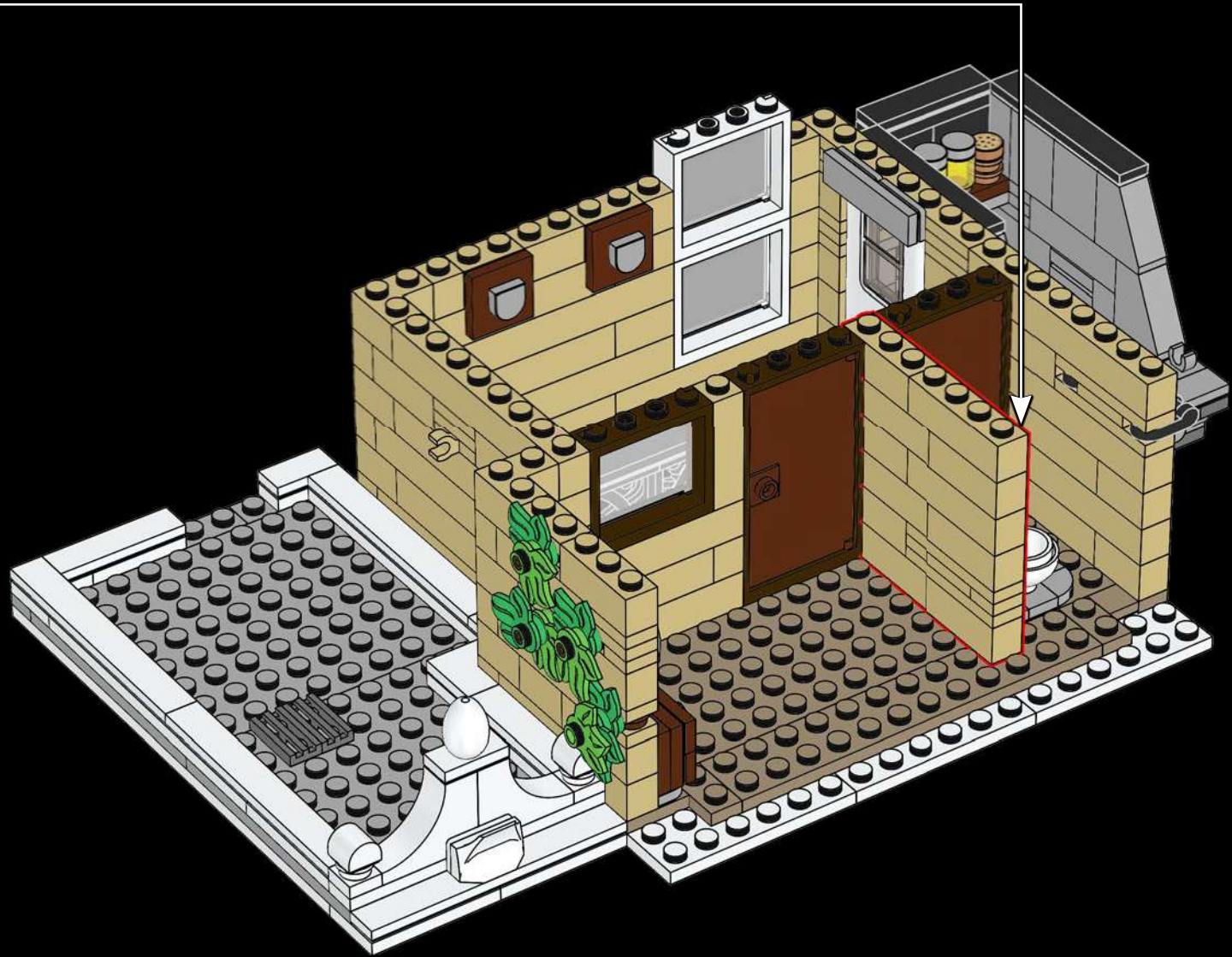

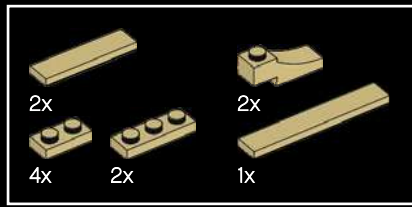

343

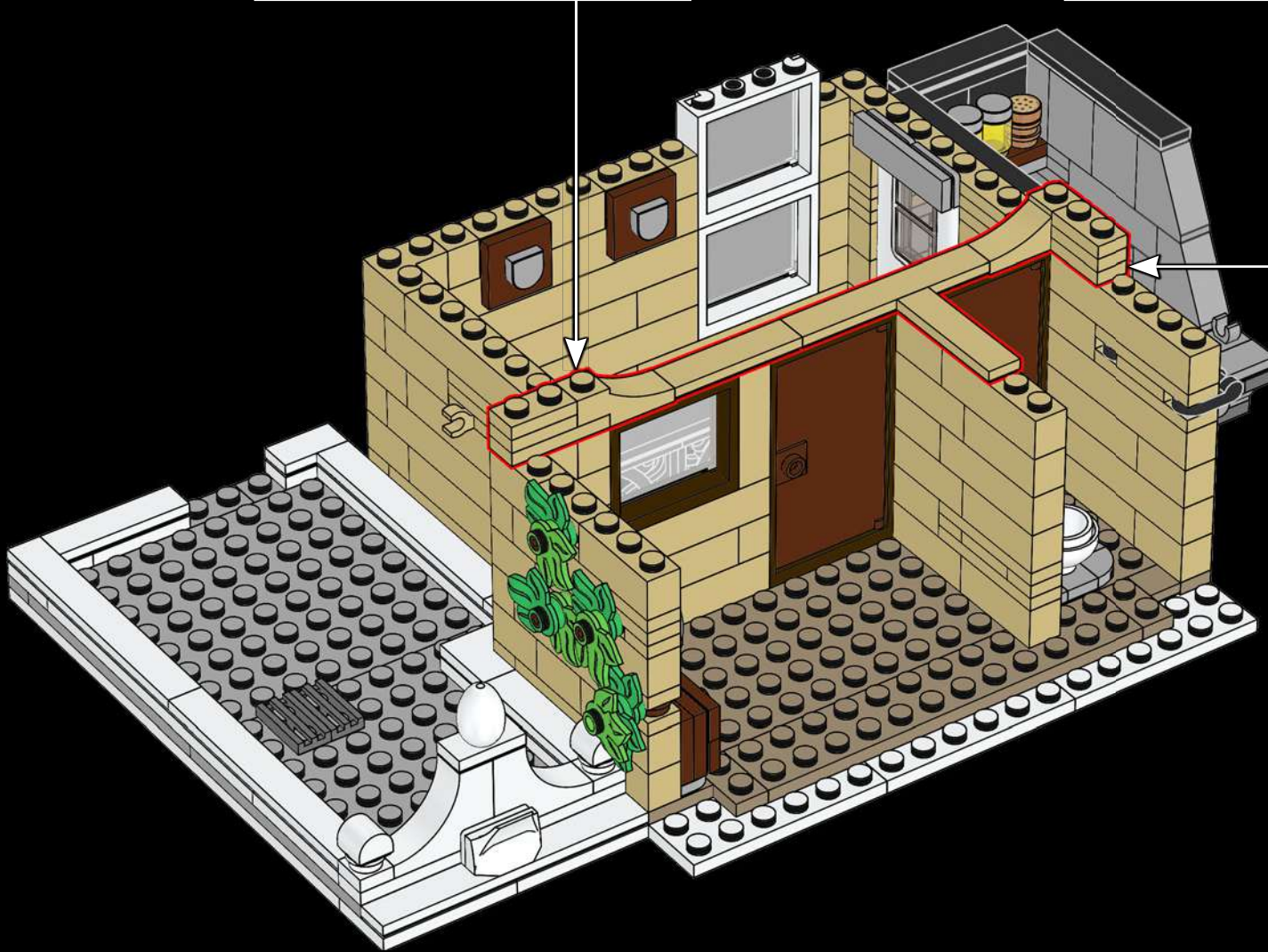
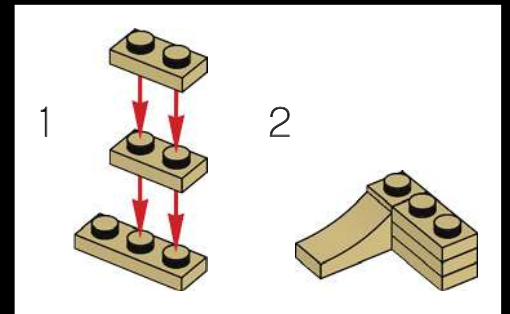
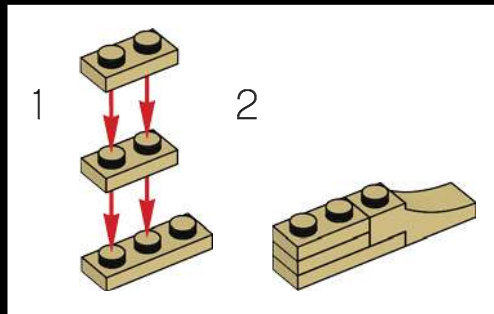

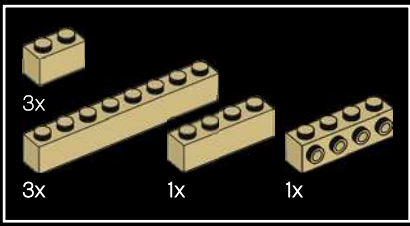

344

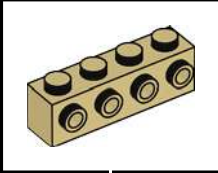

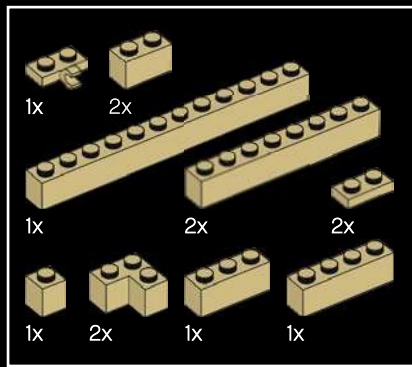

345

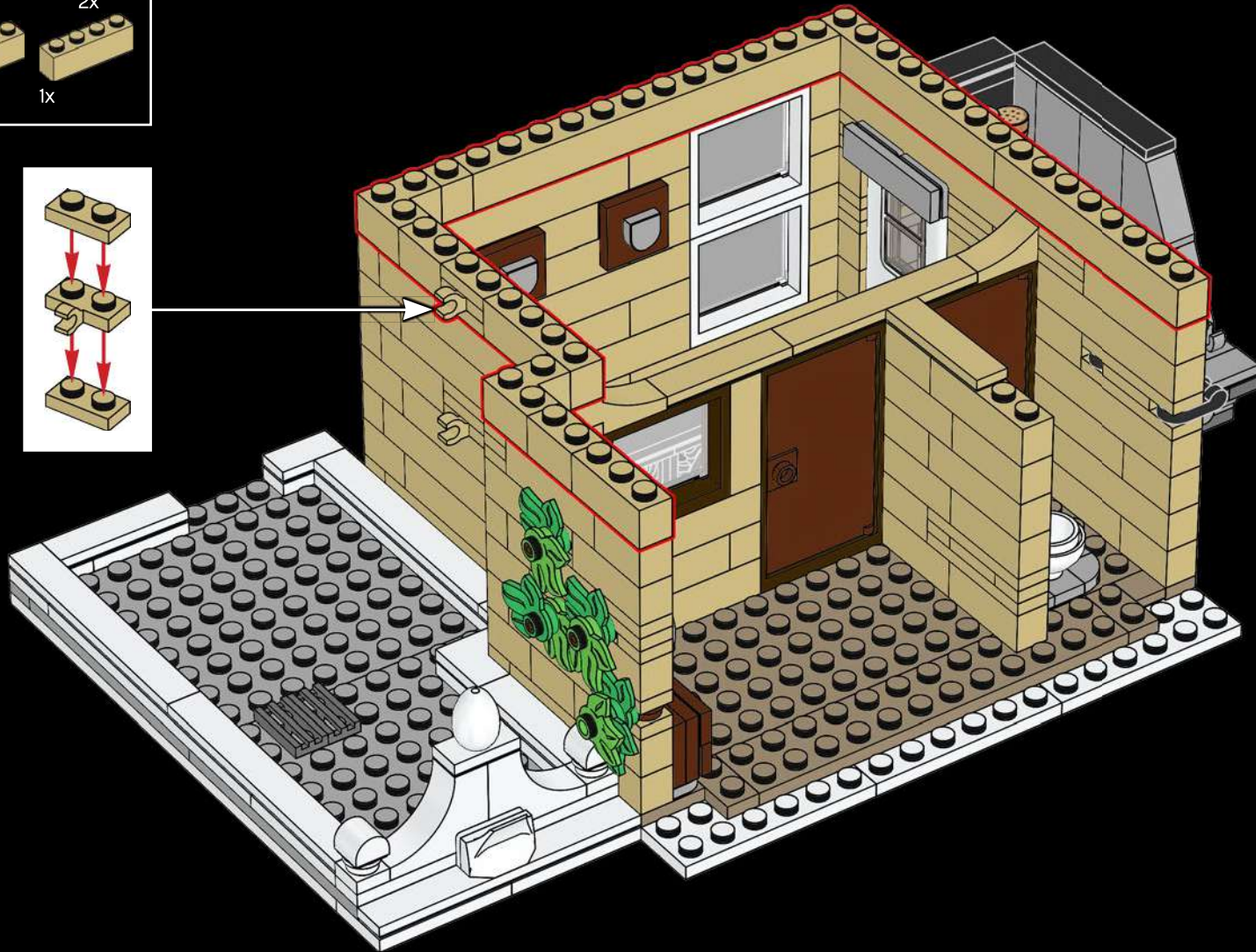
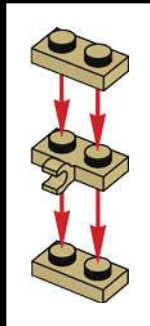

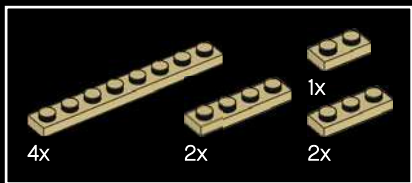

346



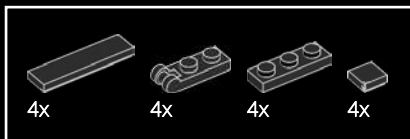

347

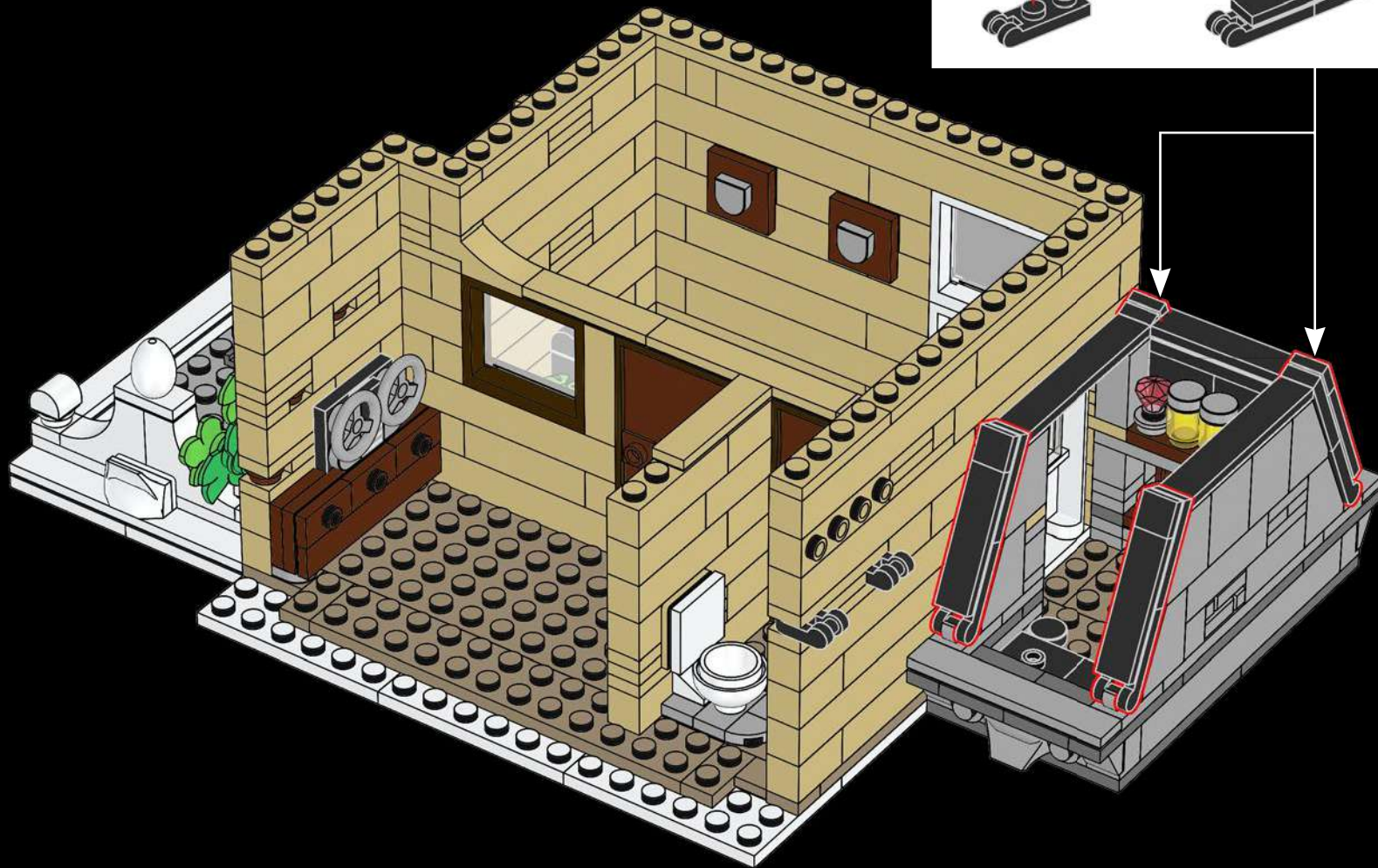
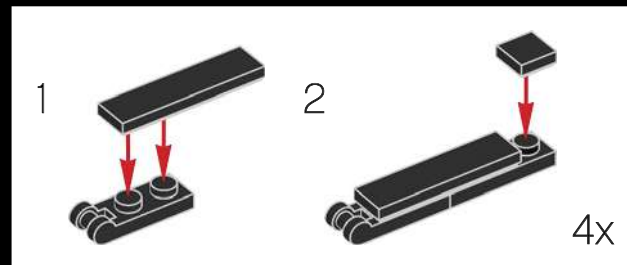

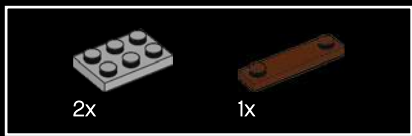

348

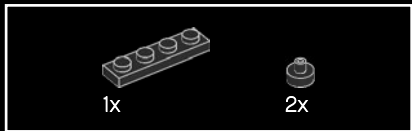
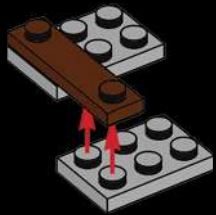

349

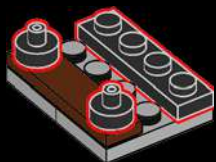

350

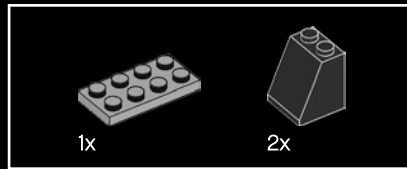

351

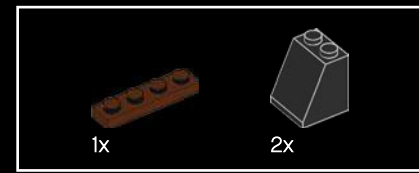

352

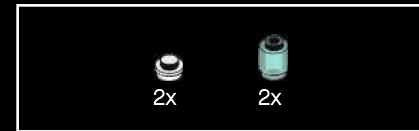
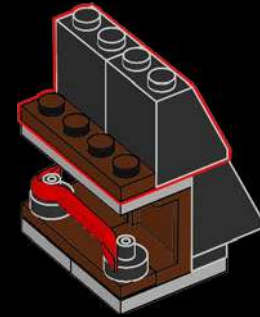

353

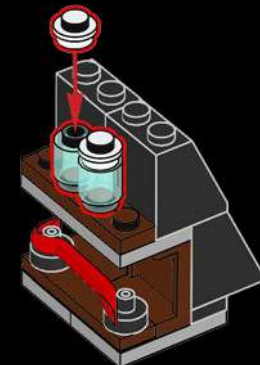

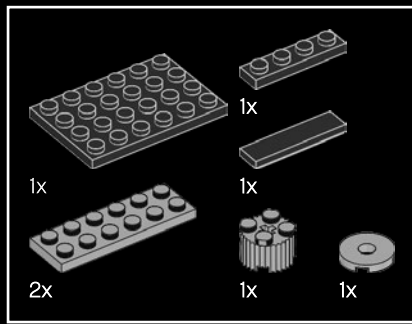

354

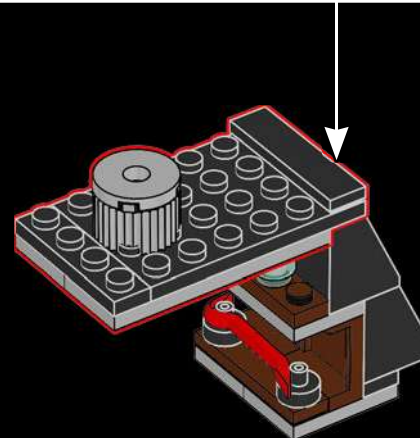
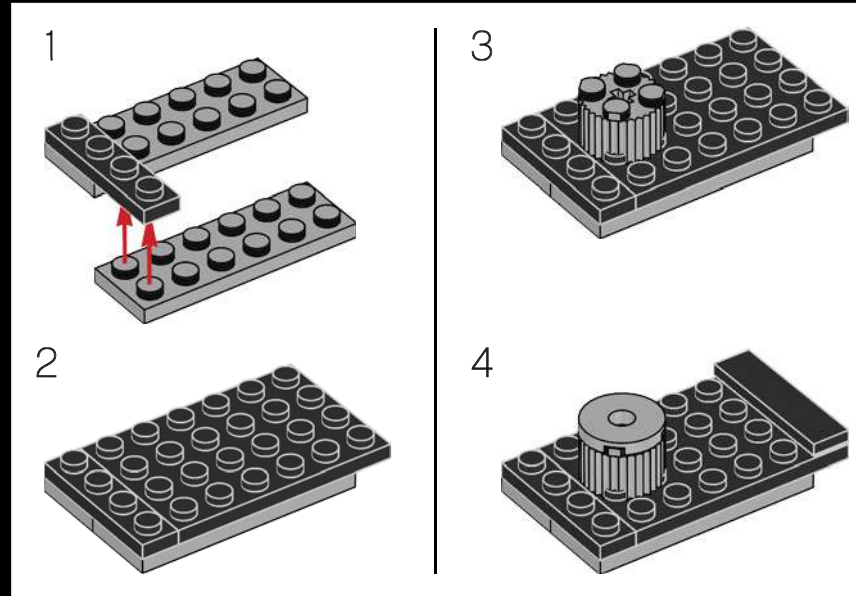

355

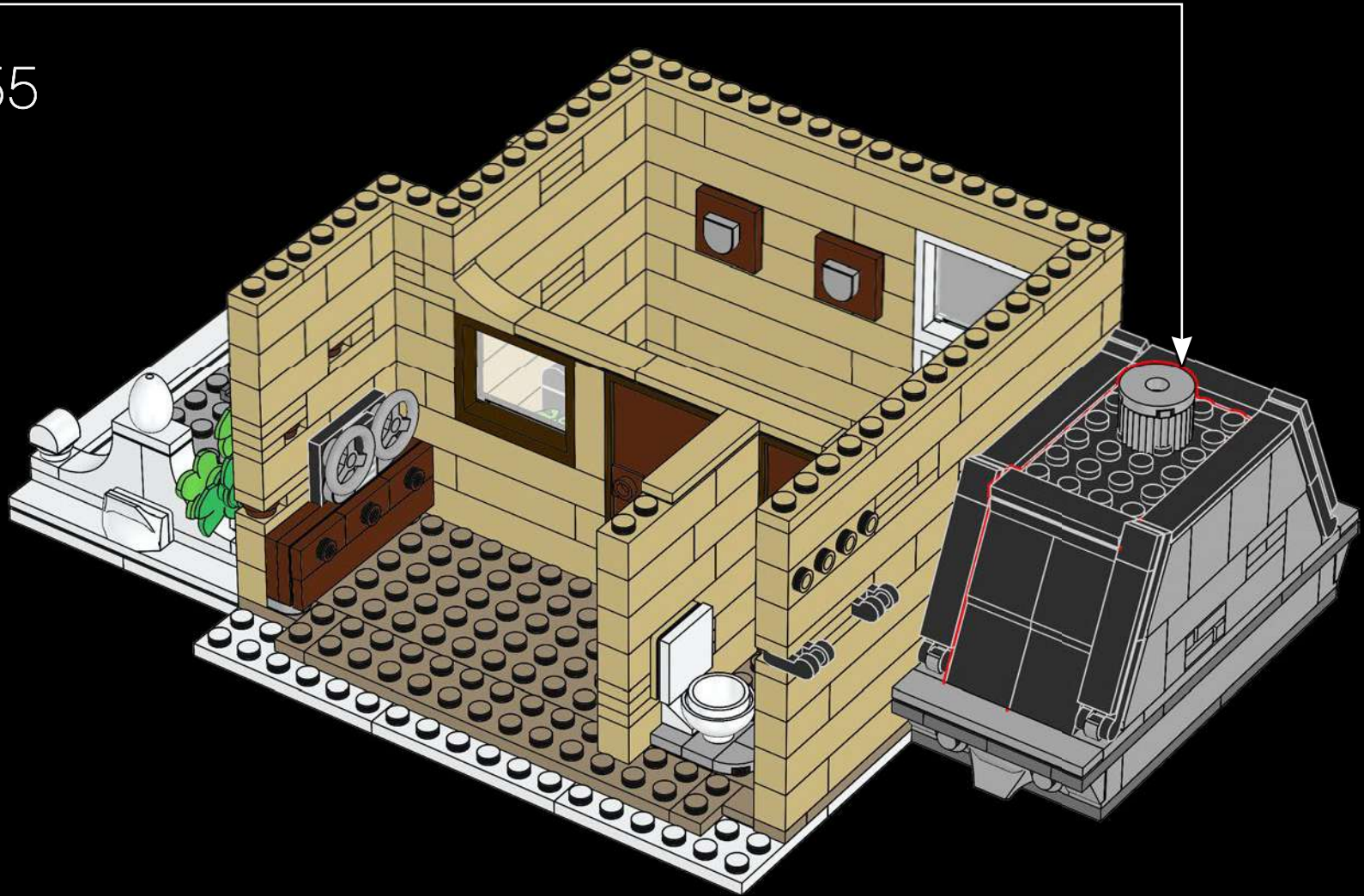



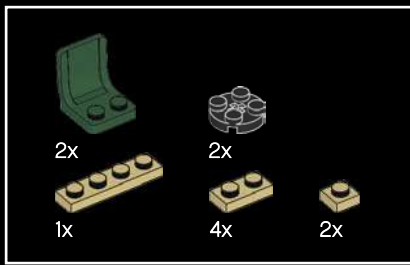

356

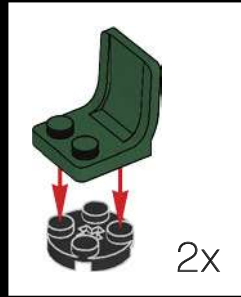



357

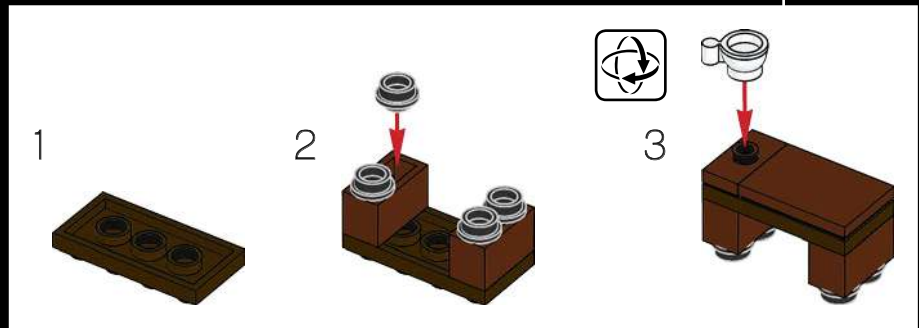

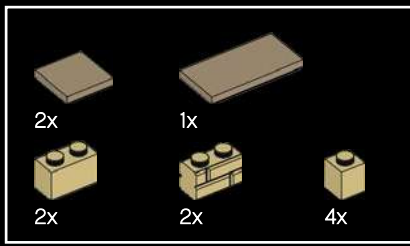

358



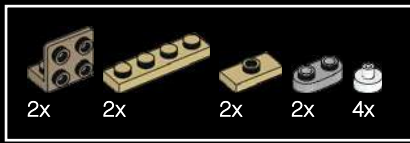

359

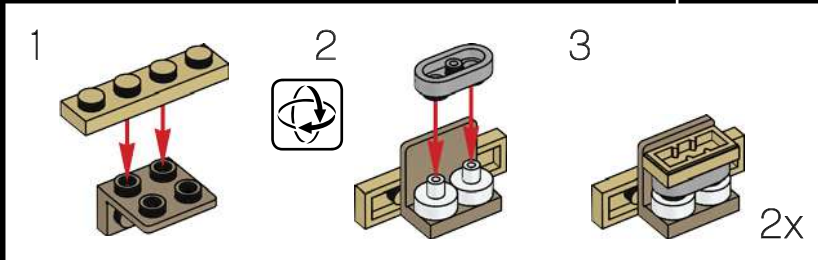
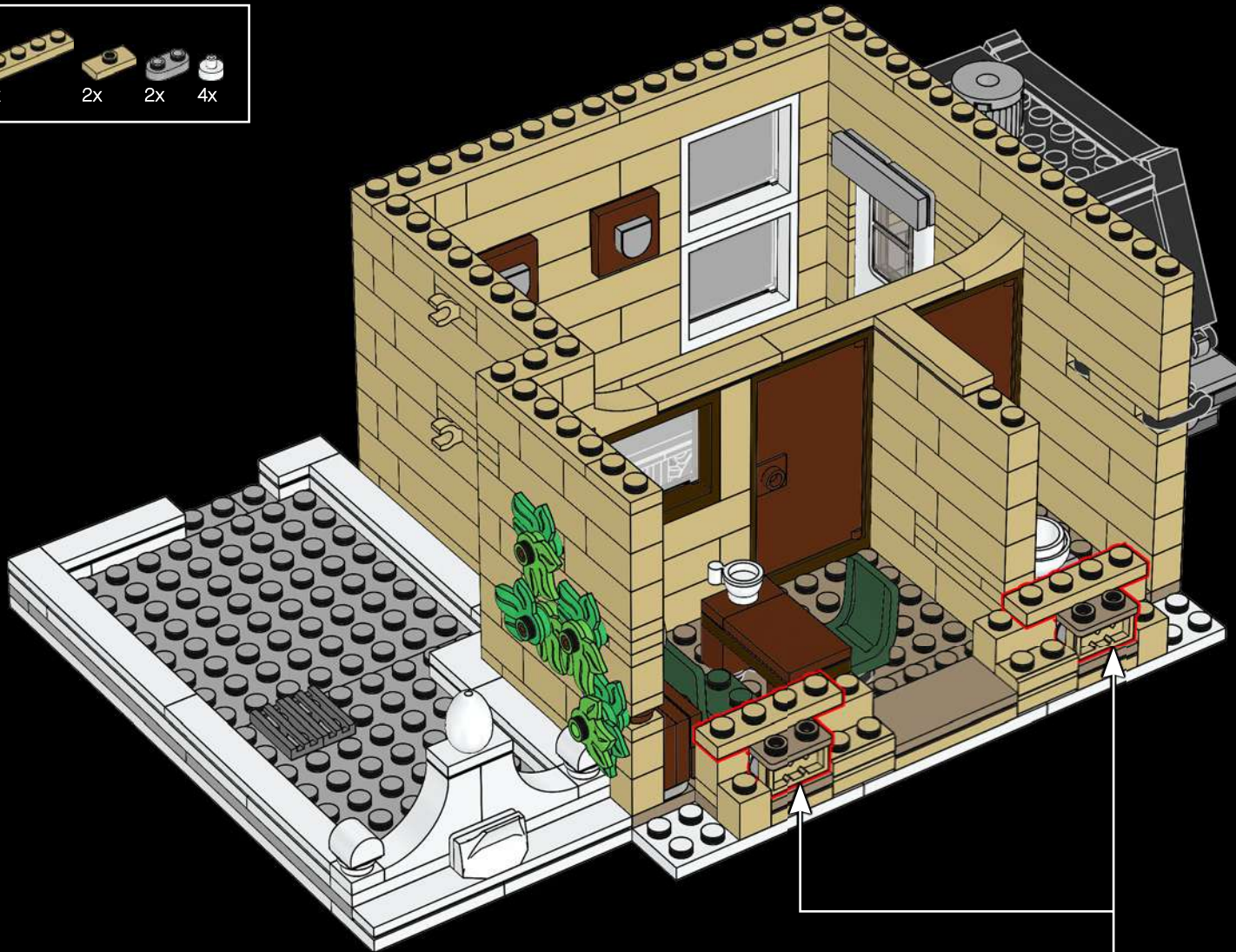

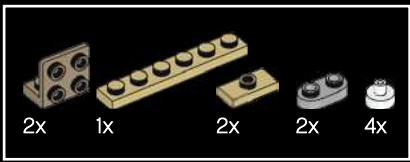

360

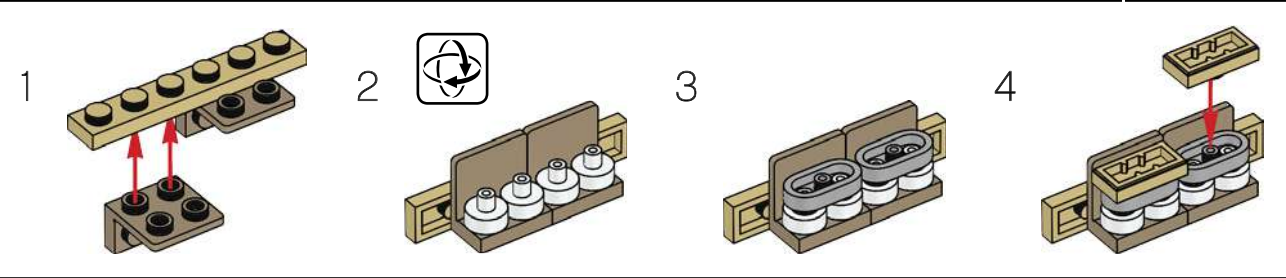
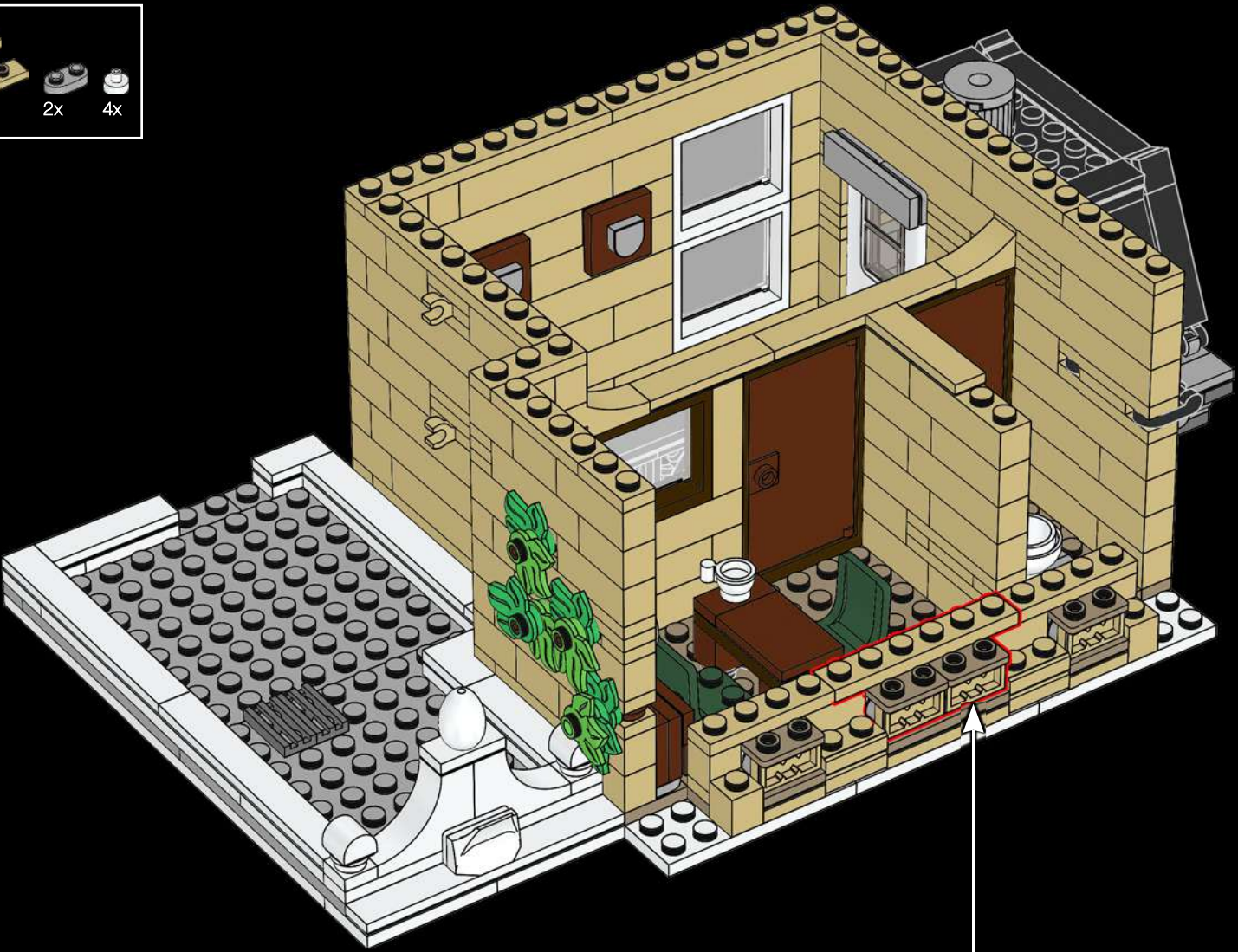

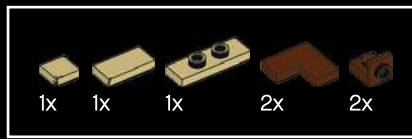

361

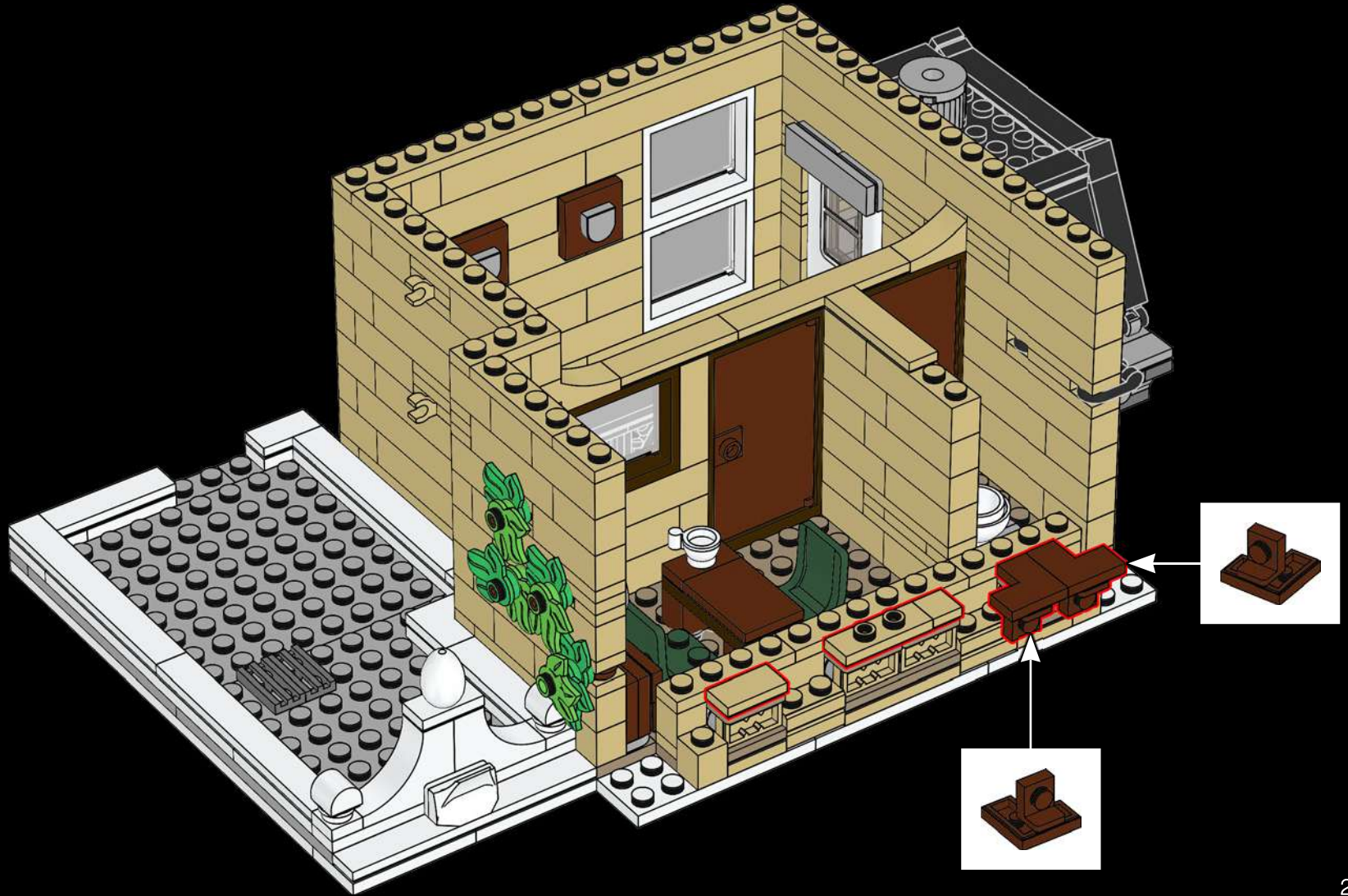

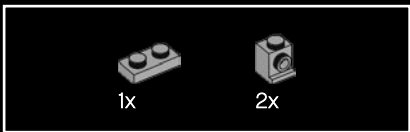

362

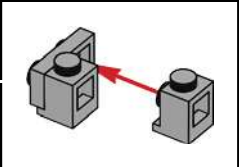
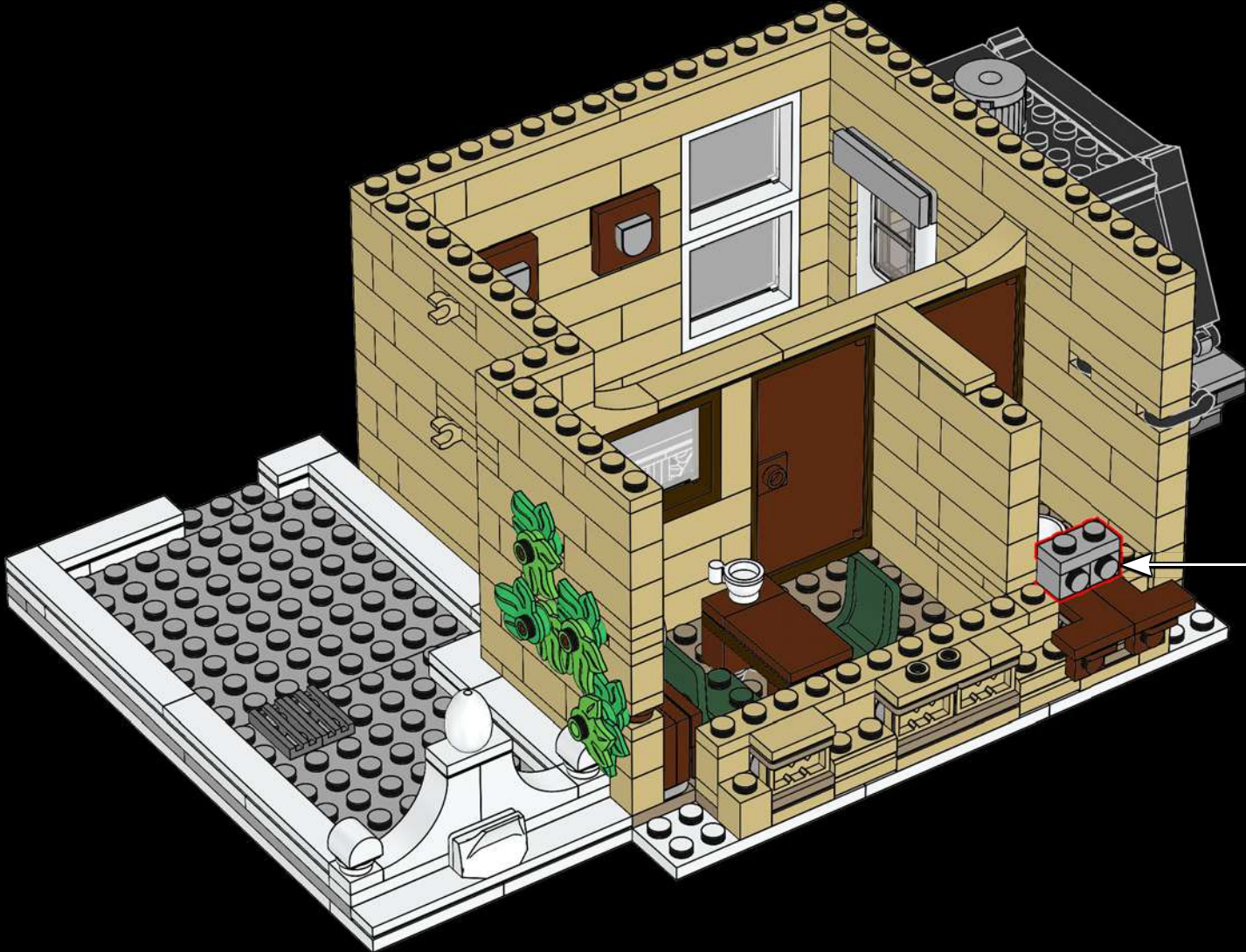

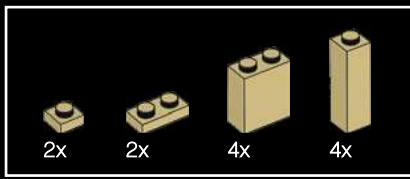

363

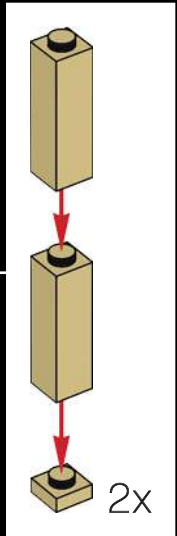
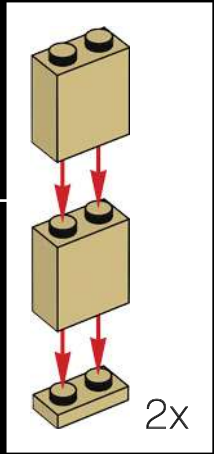
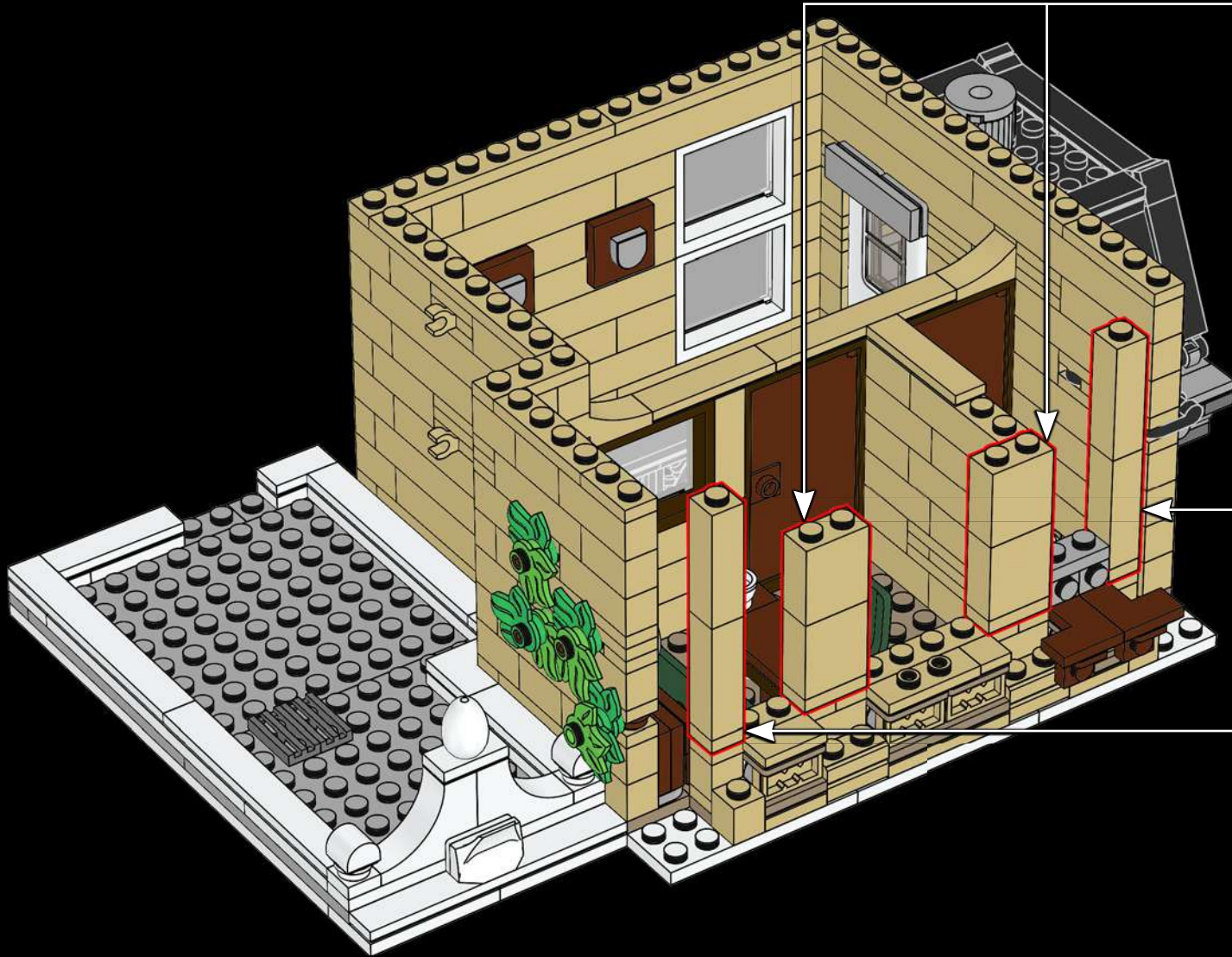

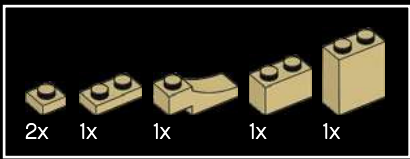

364

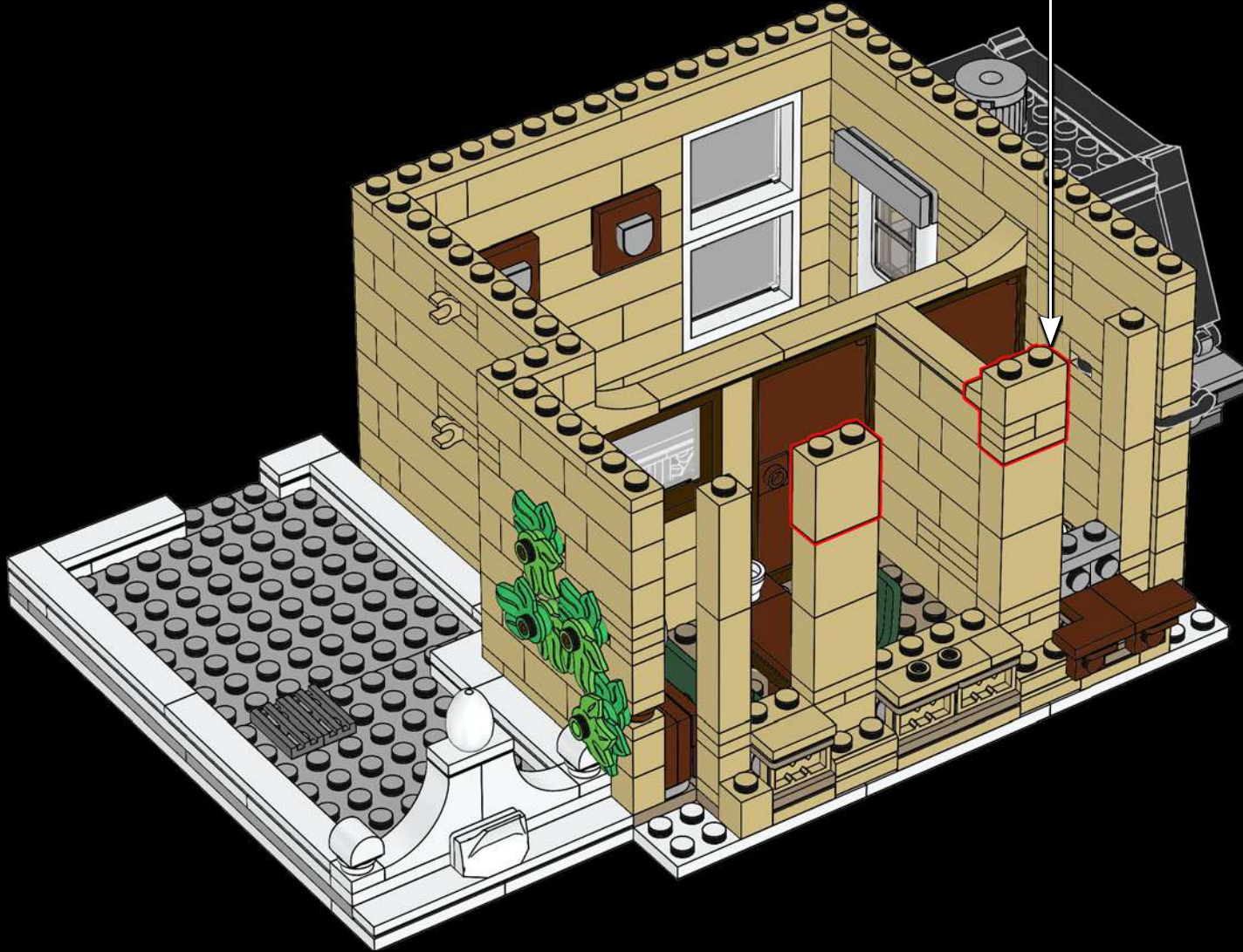
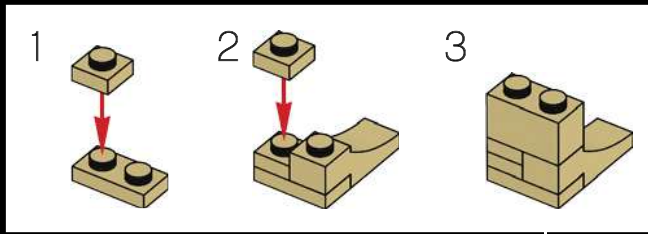

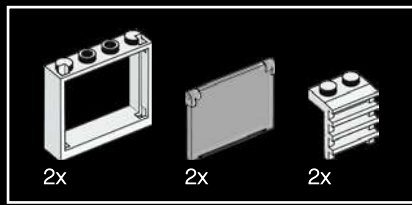

365

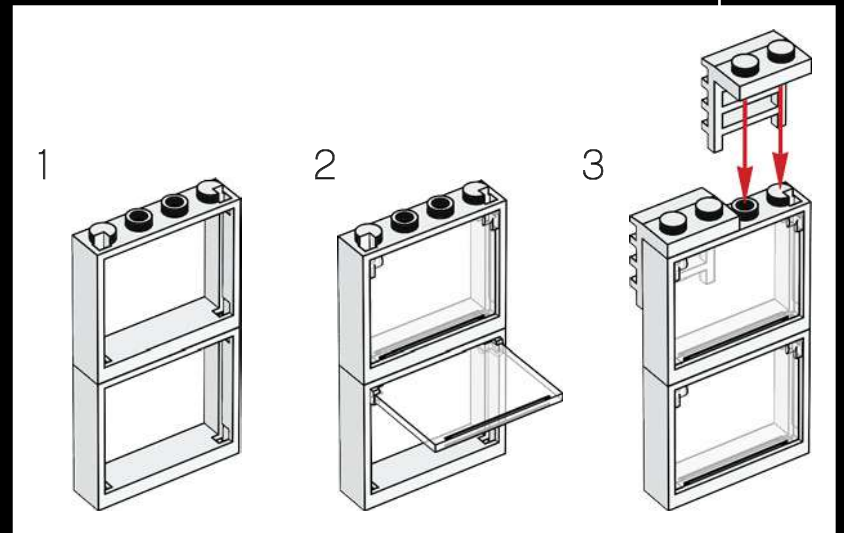
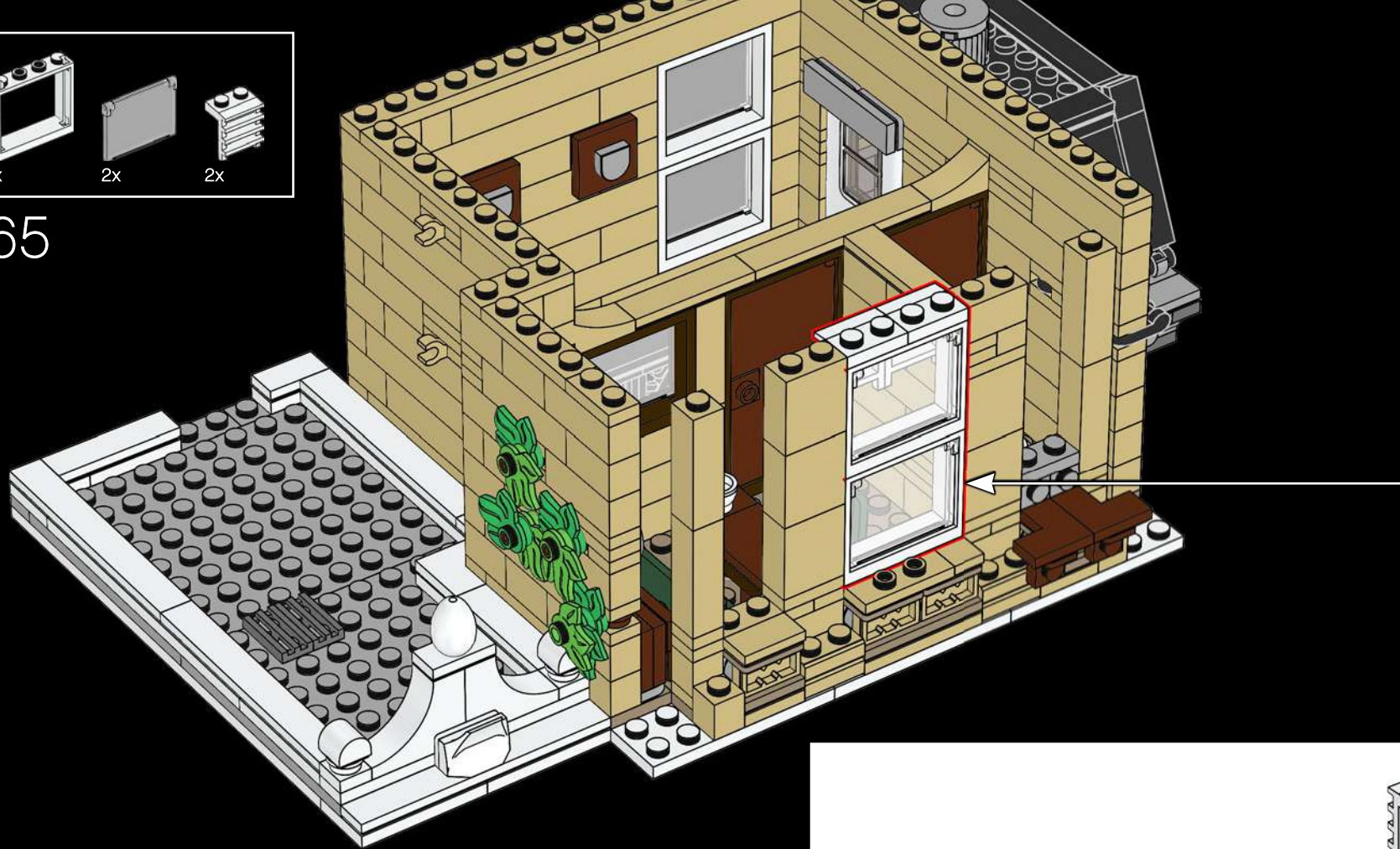

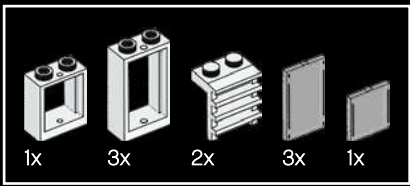

366

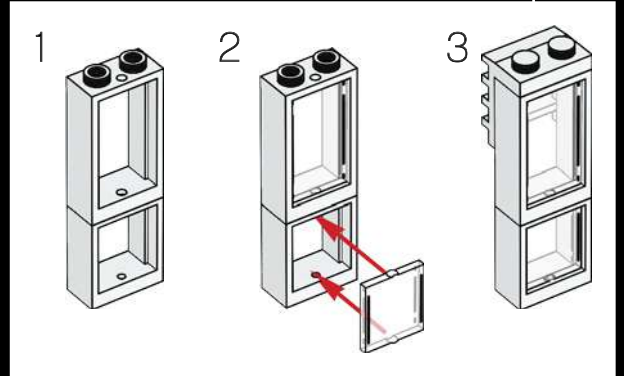
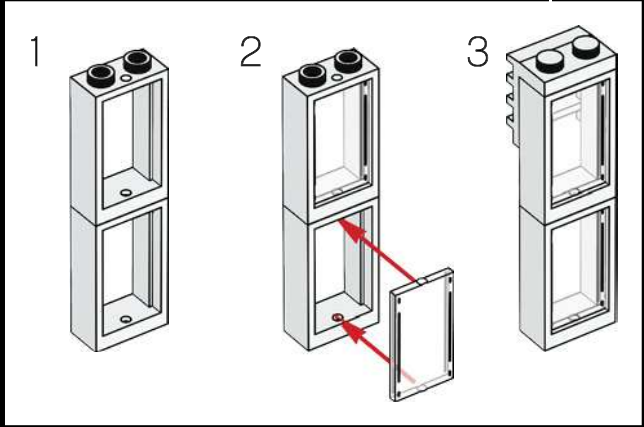

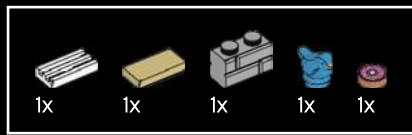

367

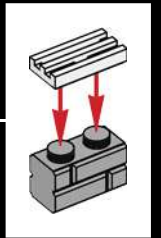
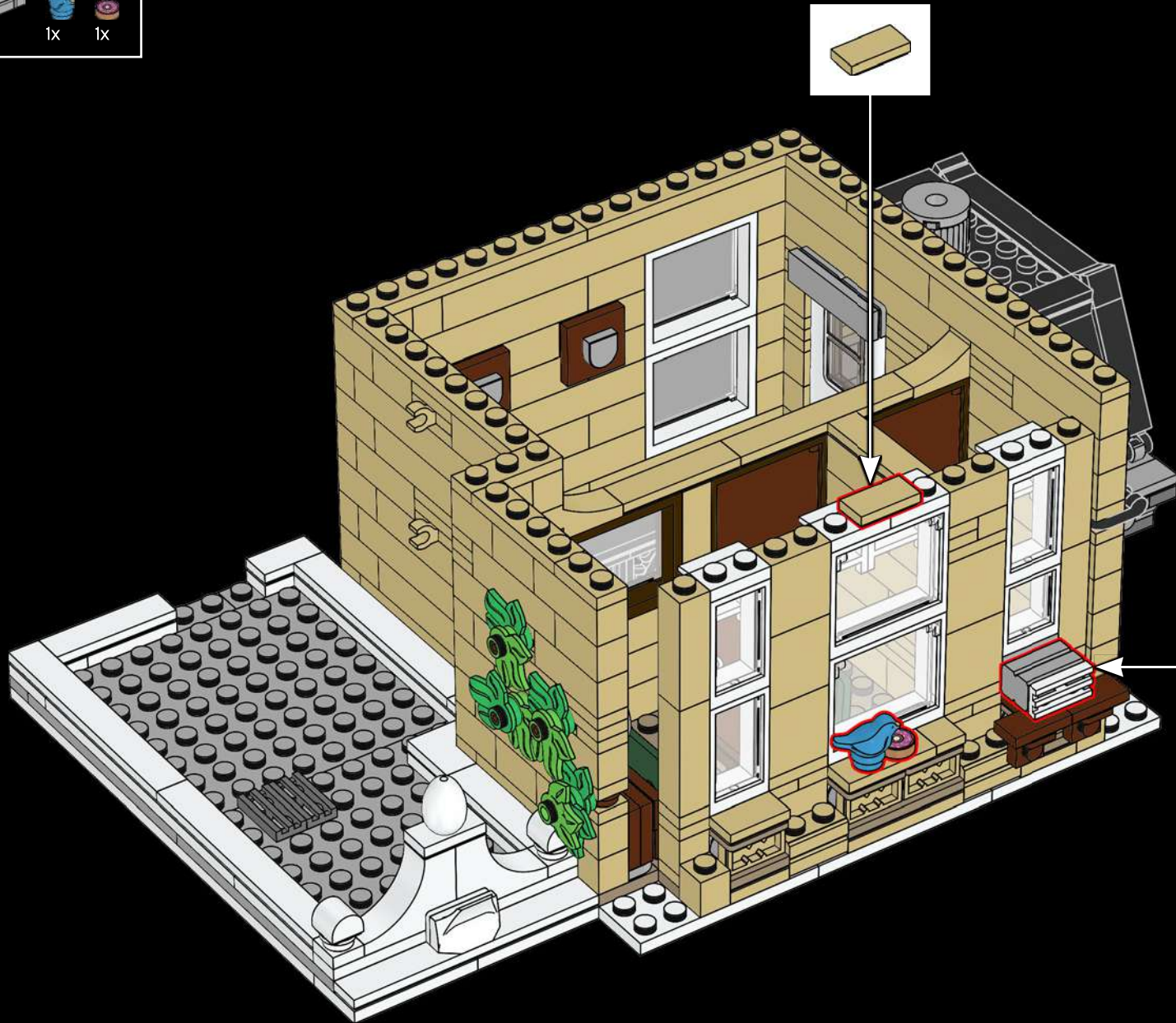

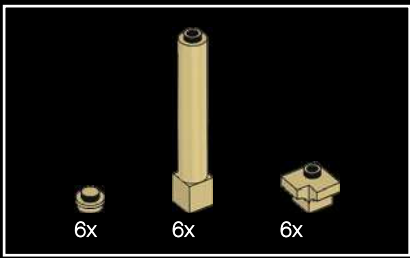

368

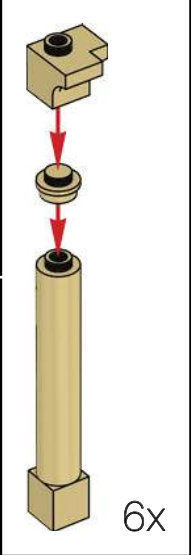
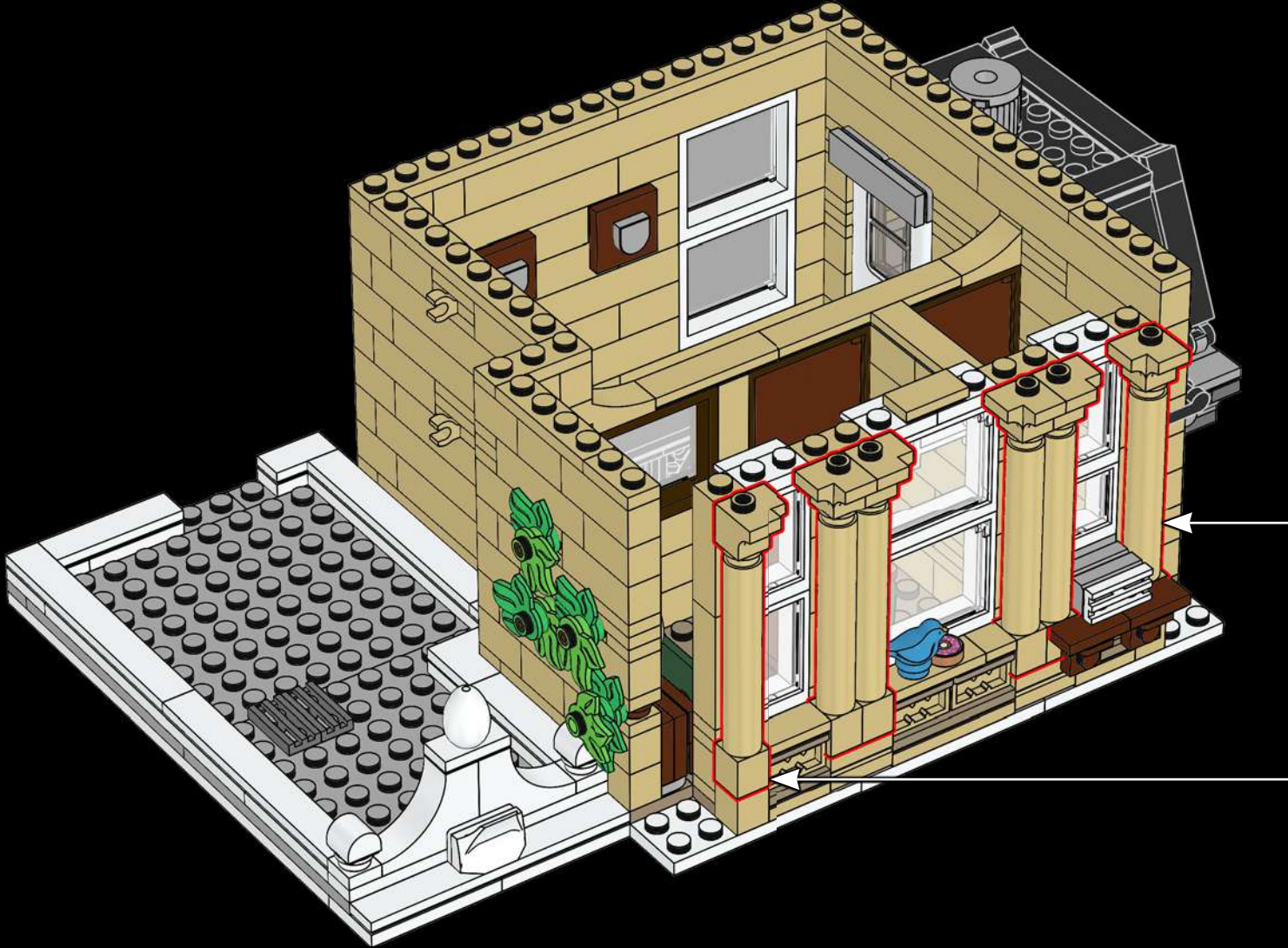

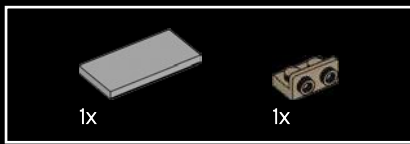

369

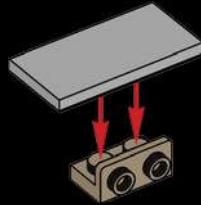

370

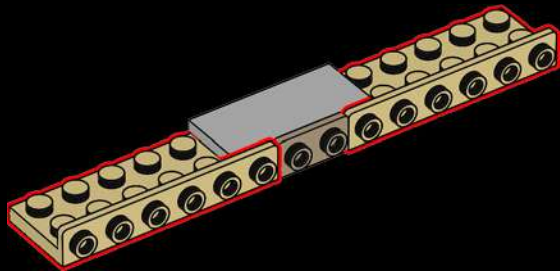

371

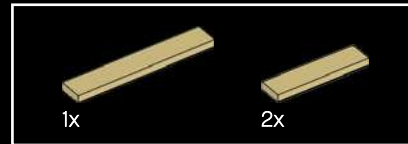
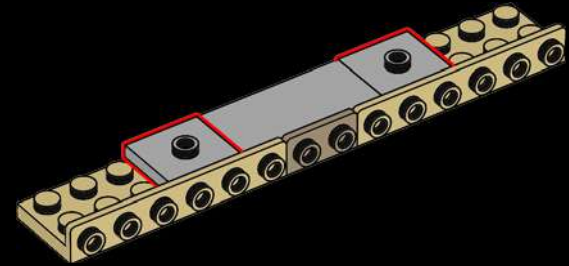

372

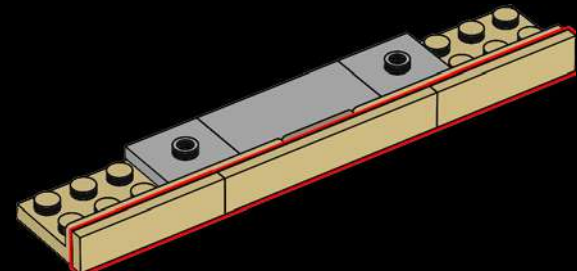

373

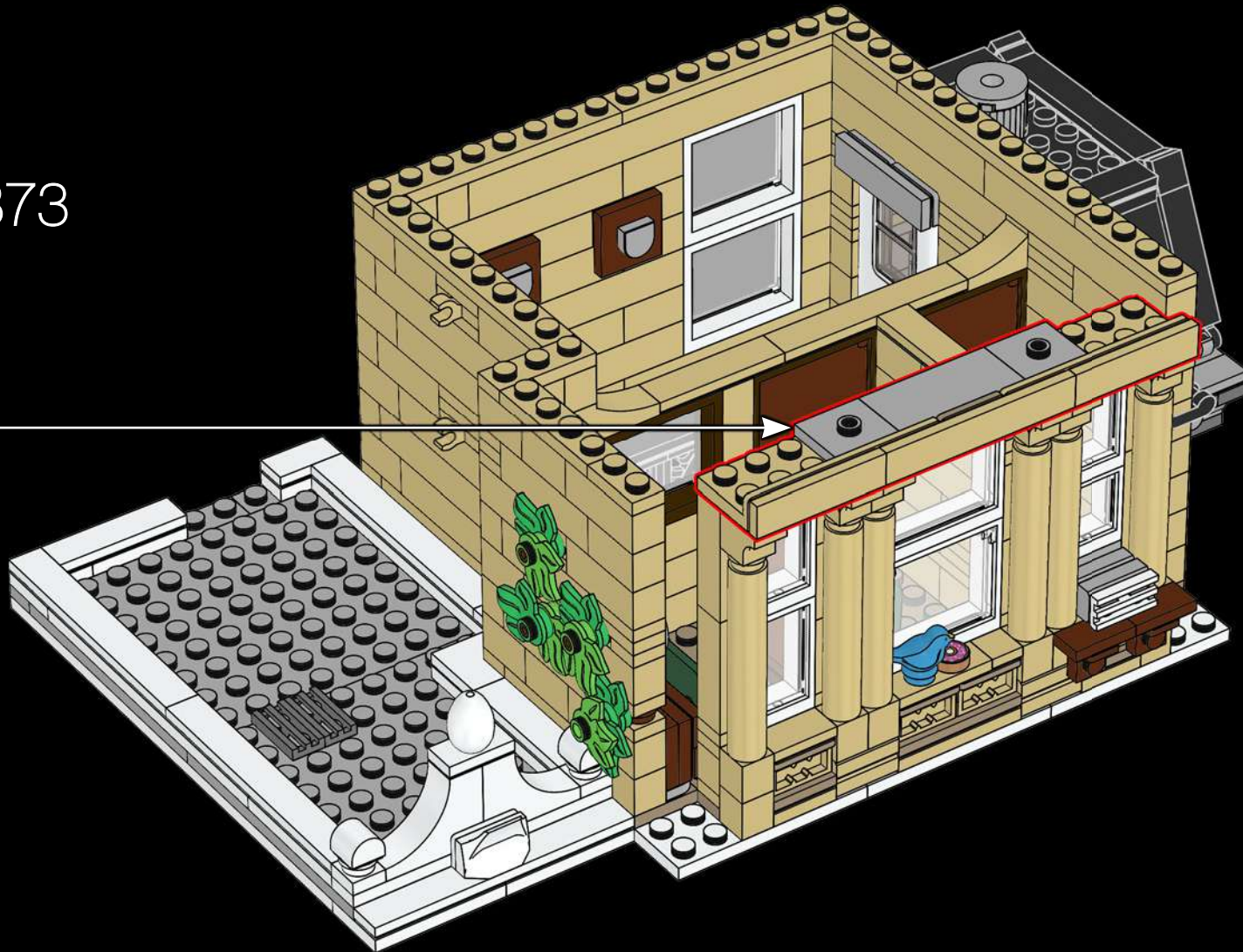

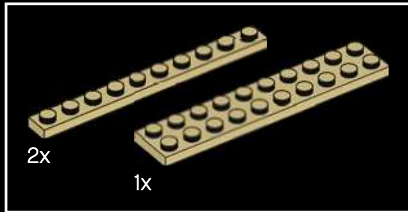
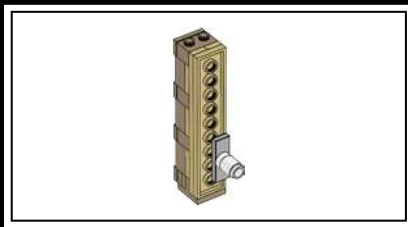

374

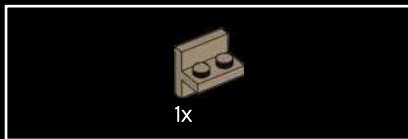

375

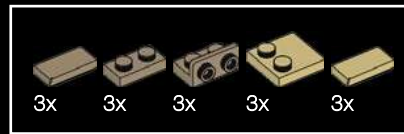
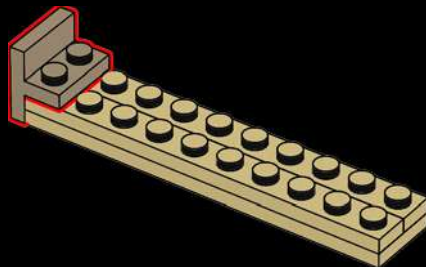
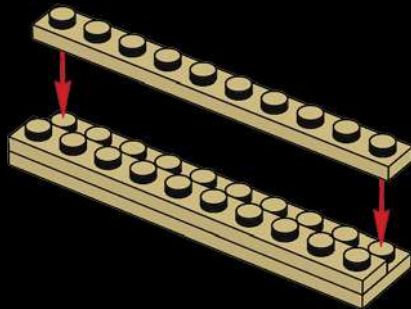

376

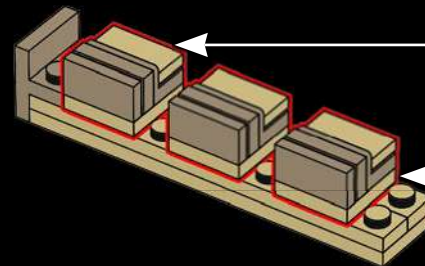
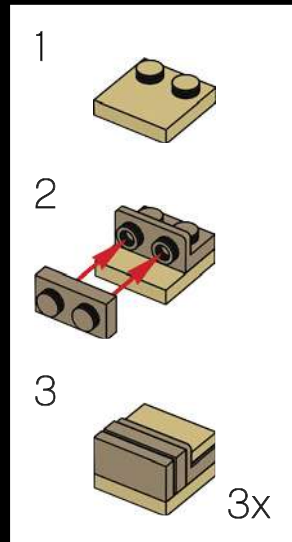



377

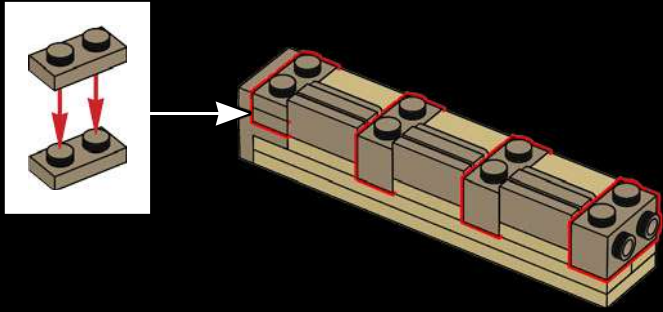

378

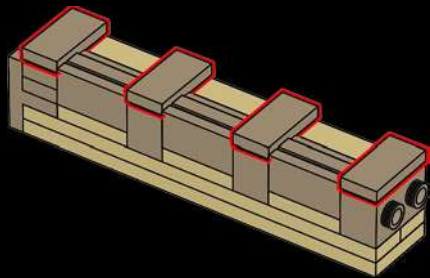

379

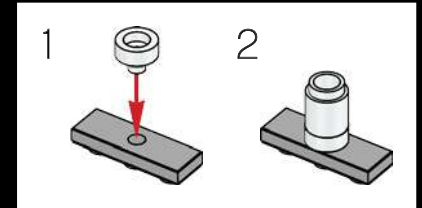
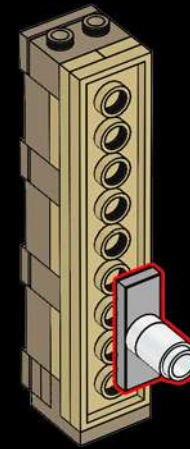

380

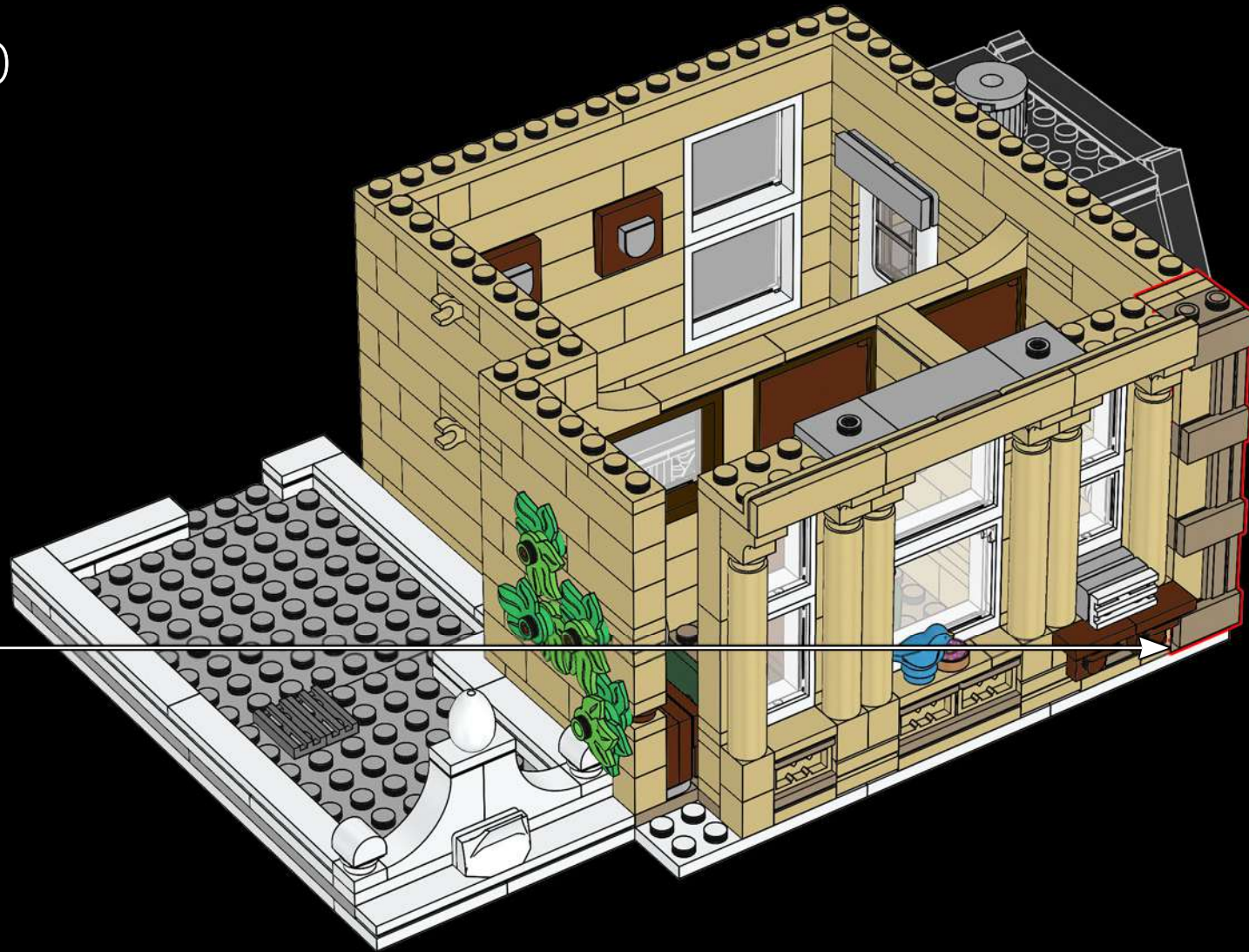

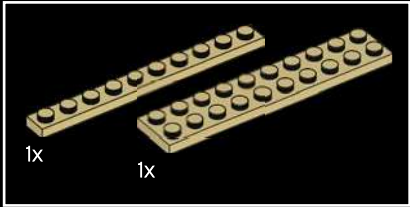
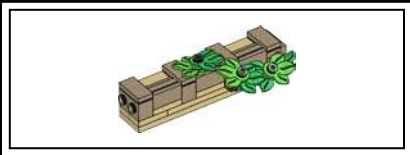

381

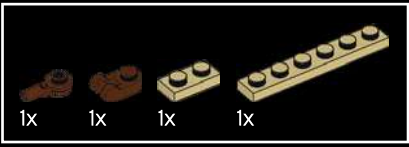
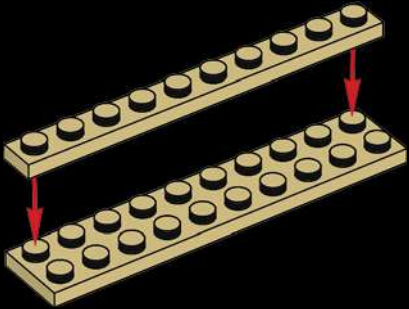

382

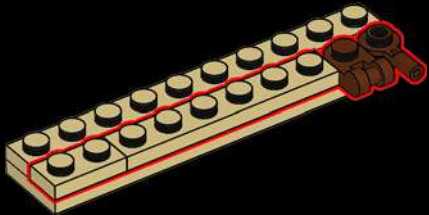

383

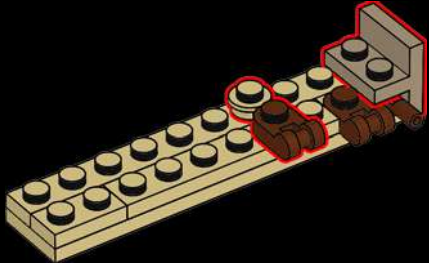

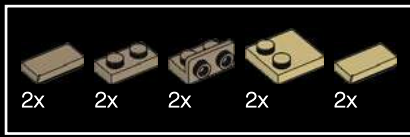

384

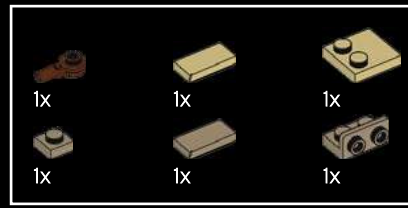
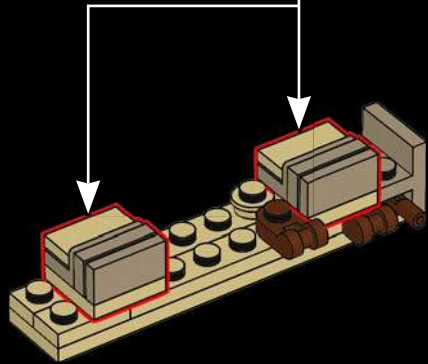
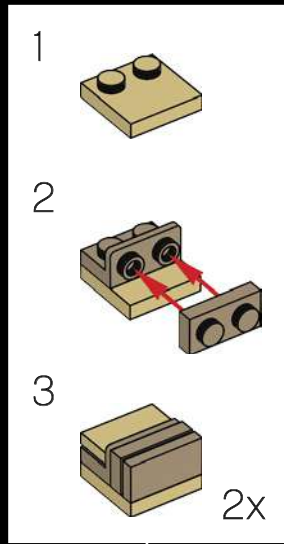

385

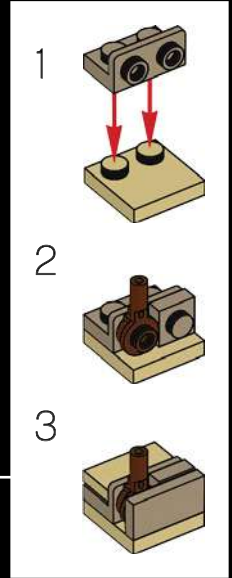
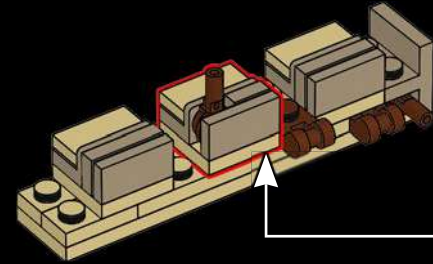

386

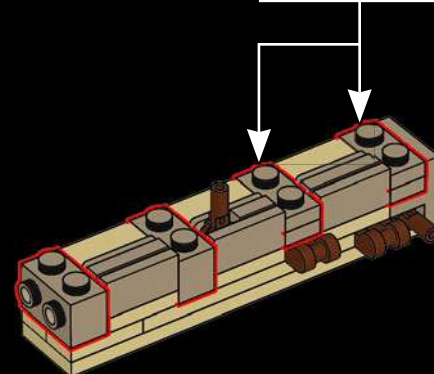
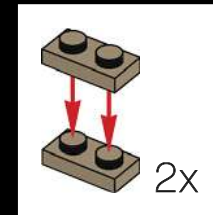



387

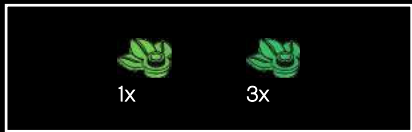
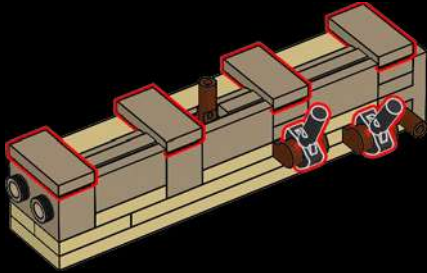

388

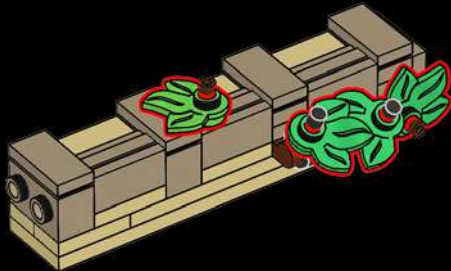

389

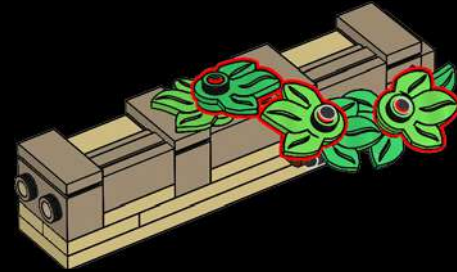

390

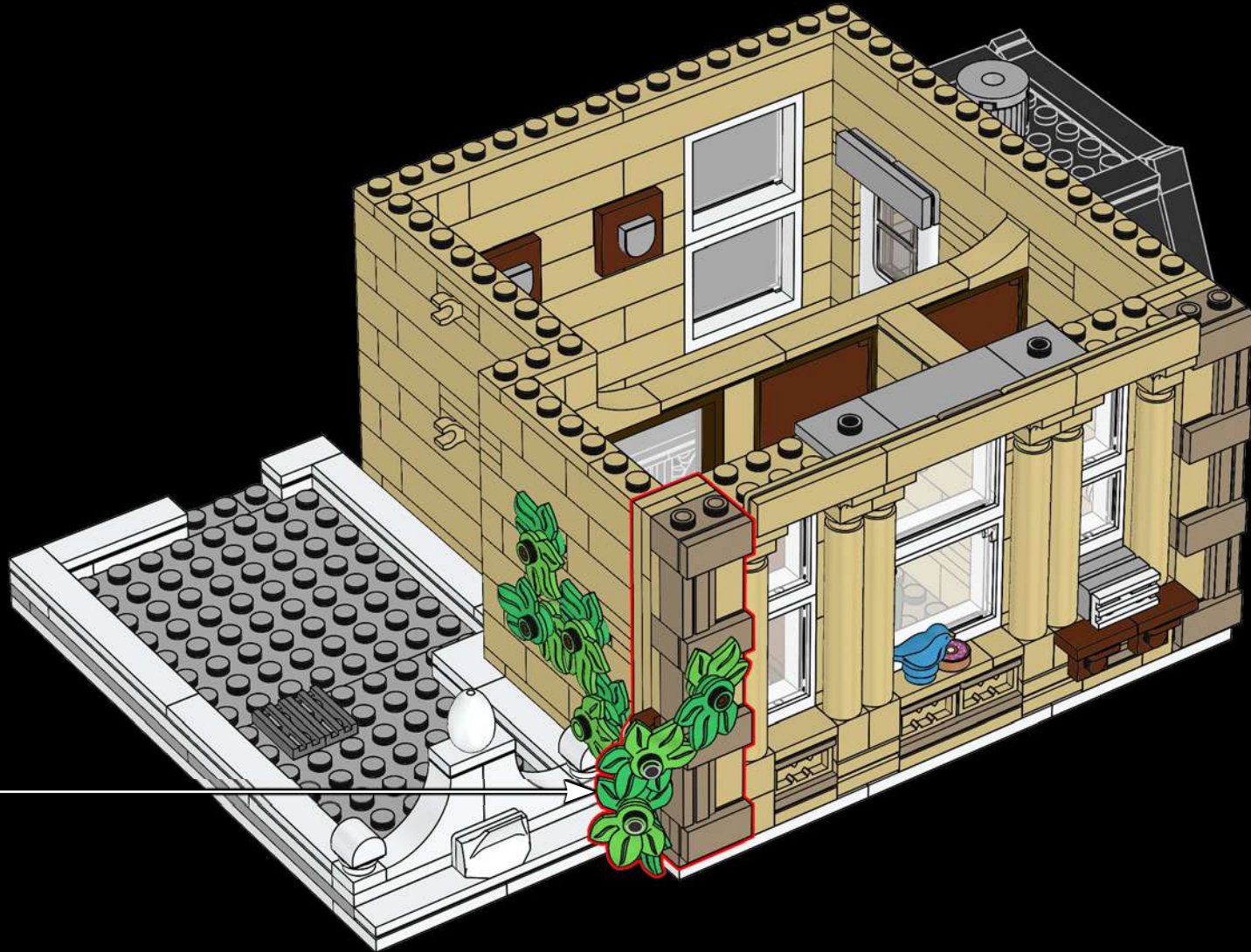

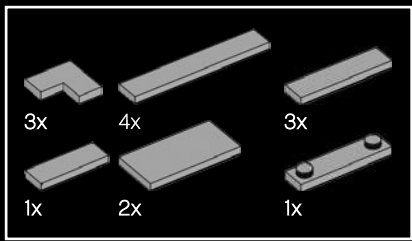

391



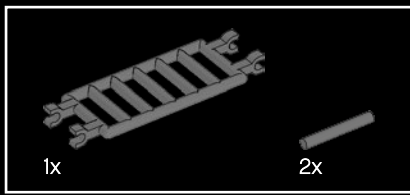

392

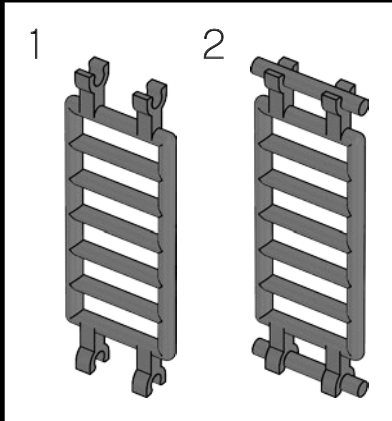

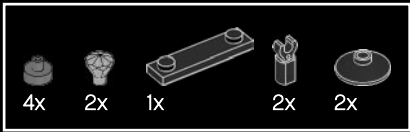

393

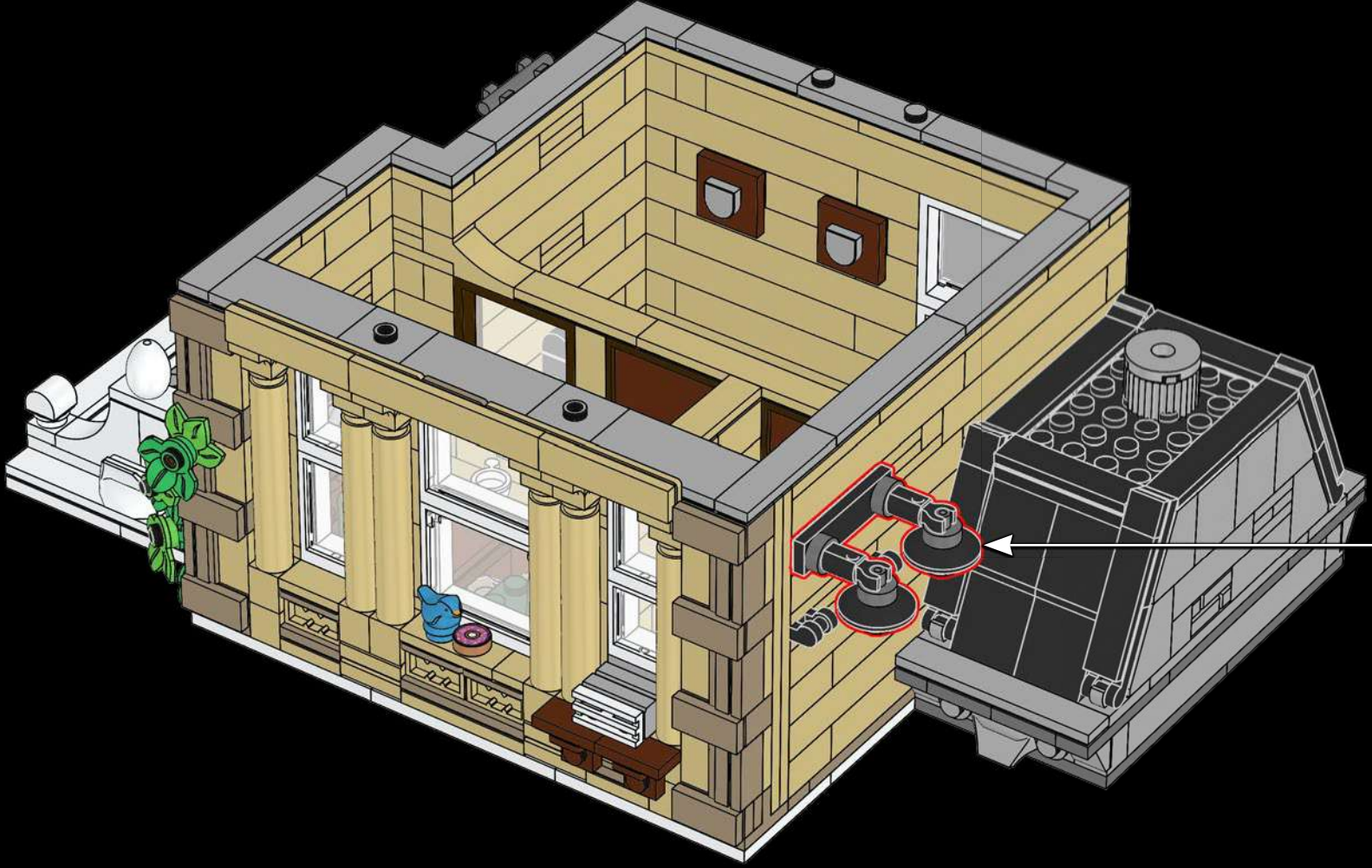

394

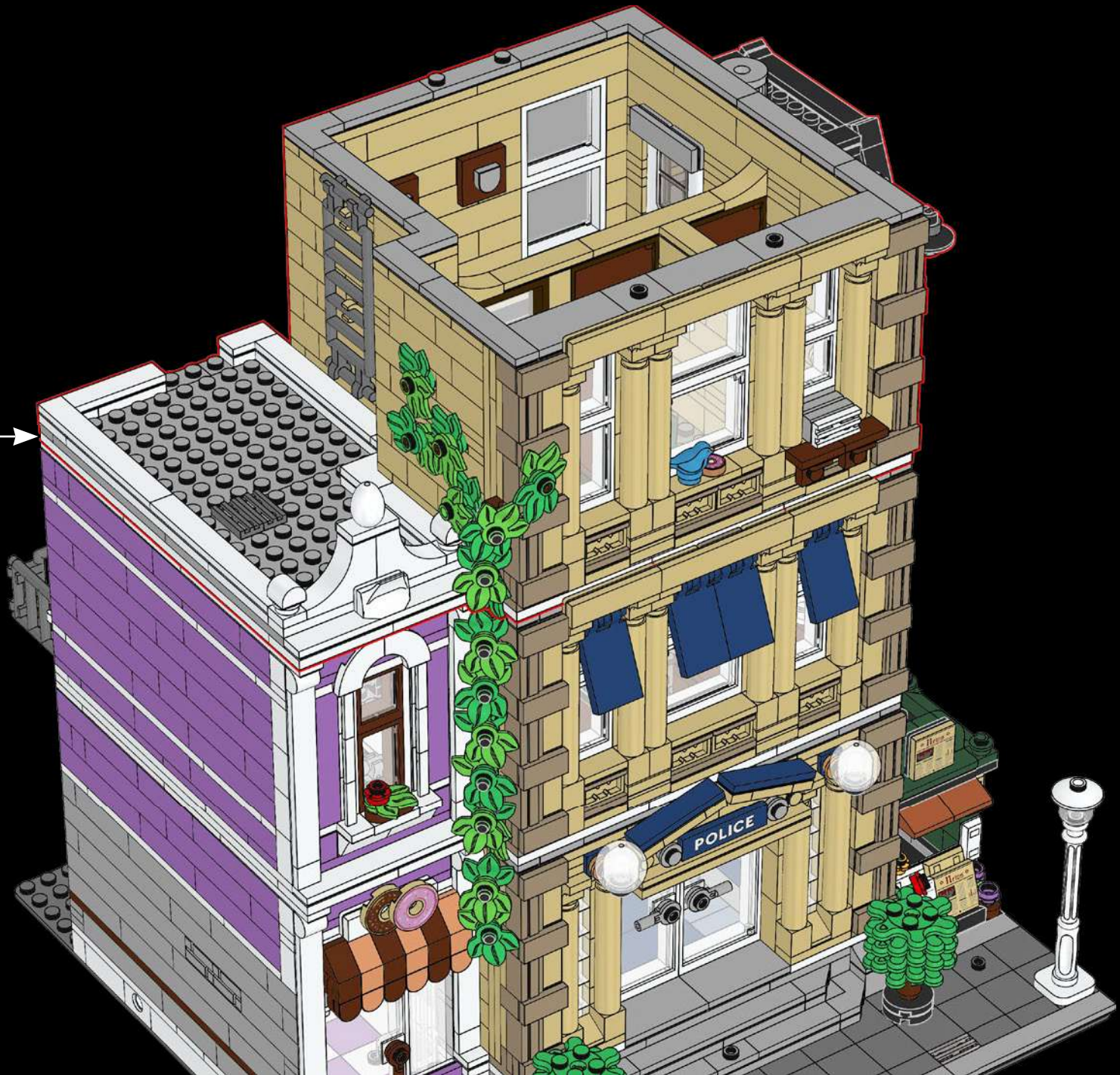

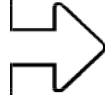

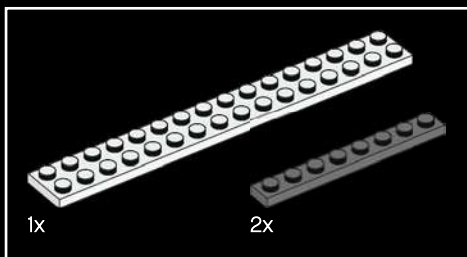
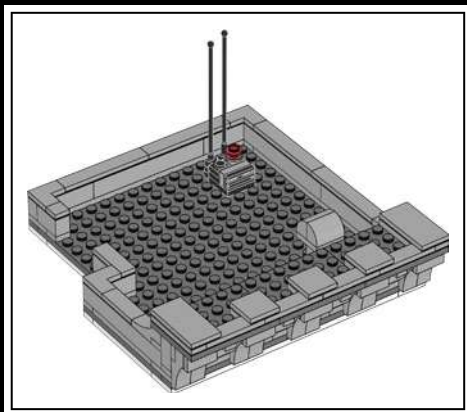

395

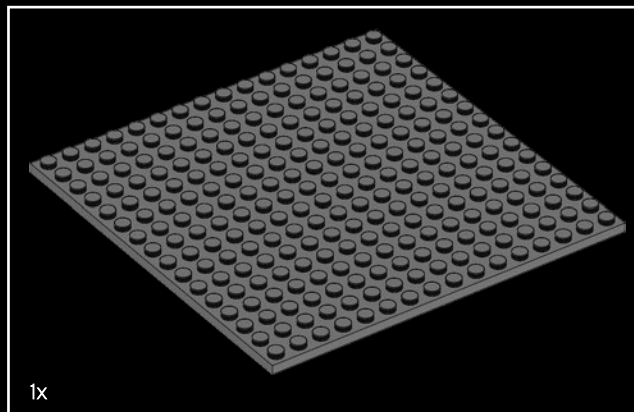
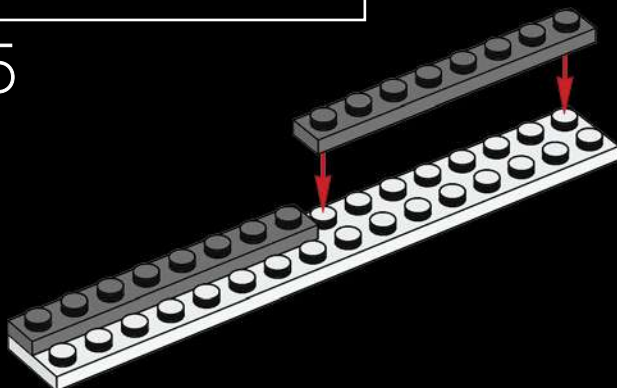

1x

396

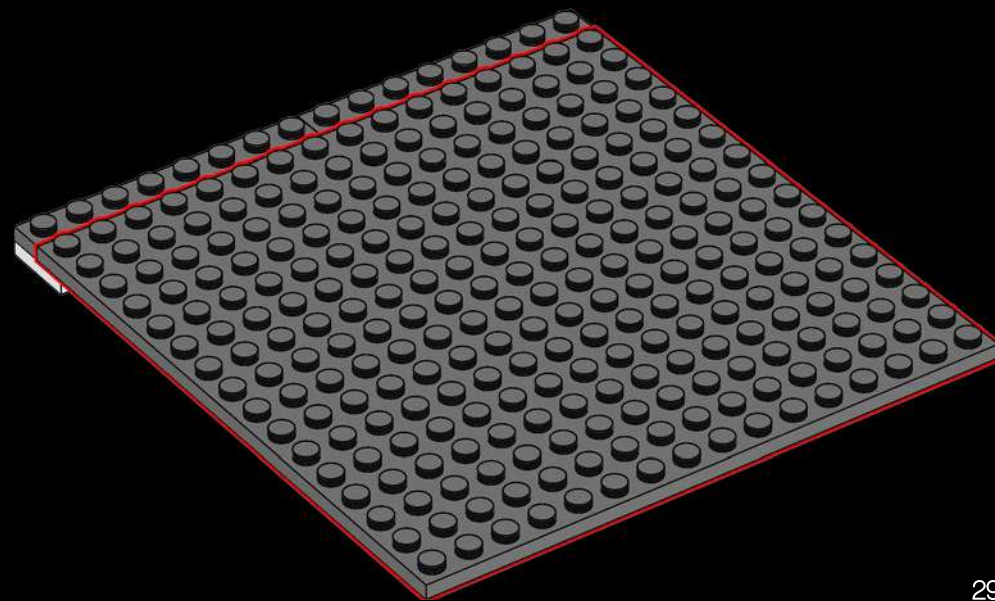

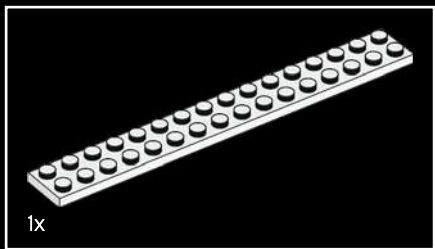

397

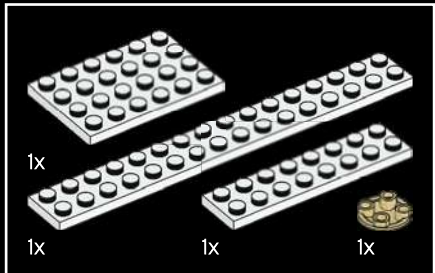
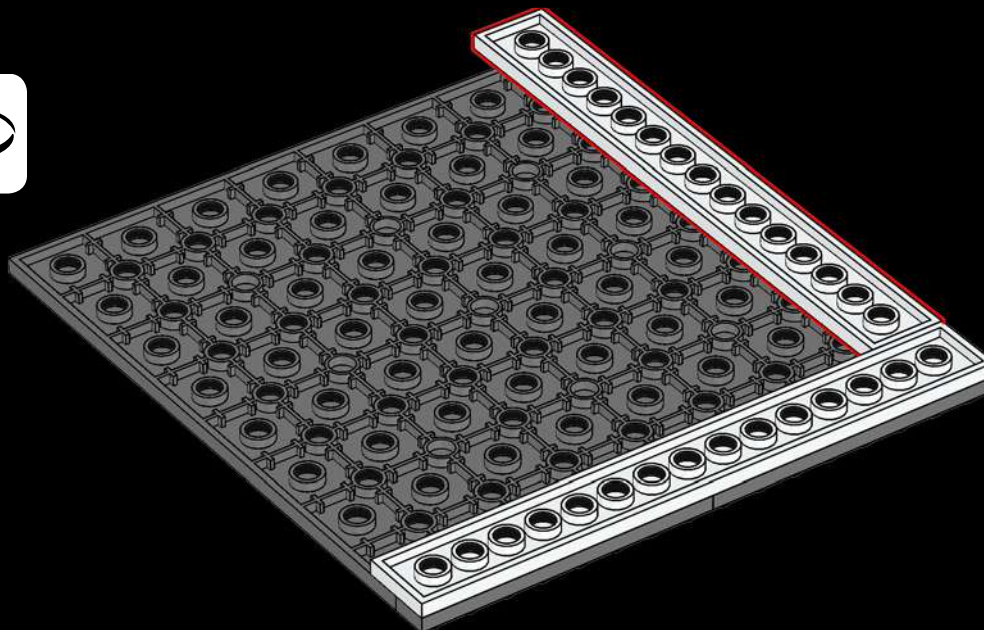

398

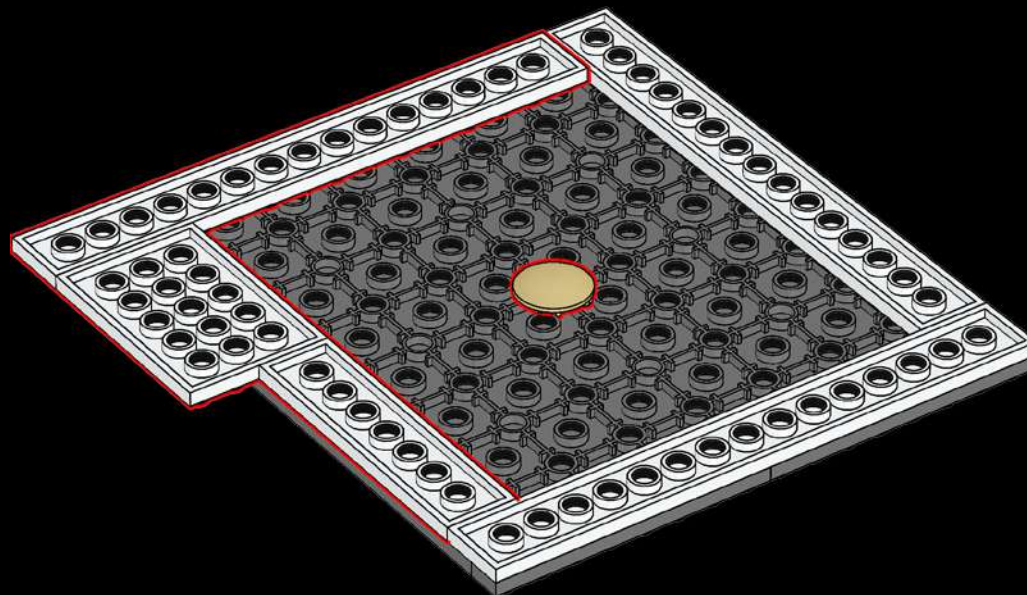

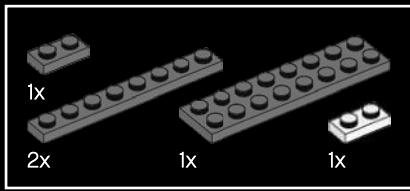

399

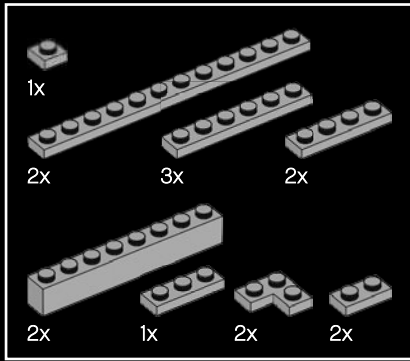
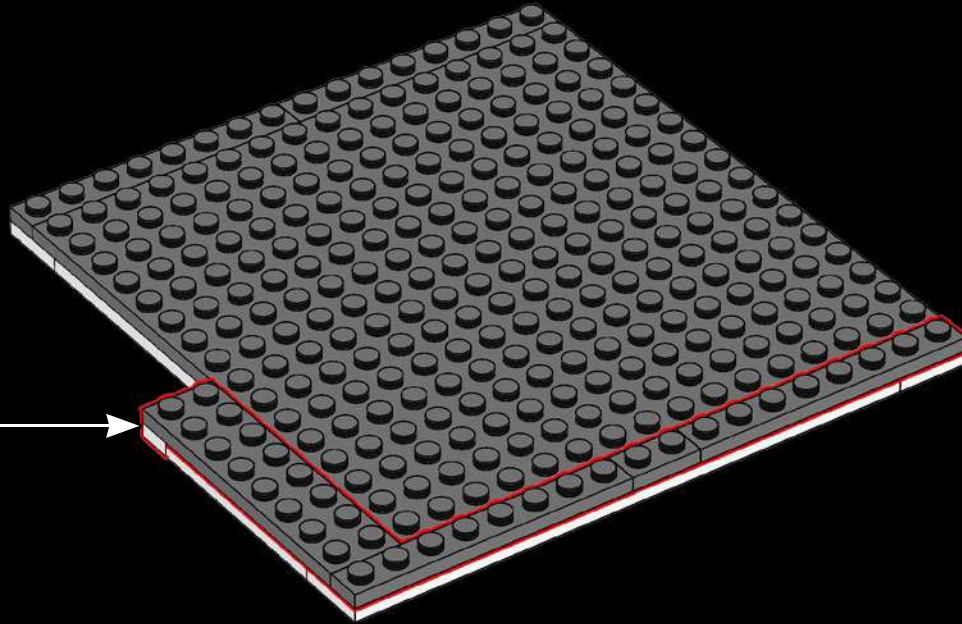
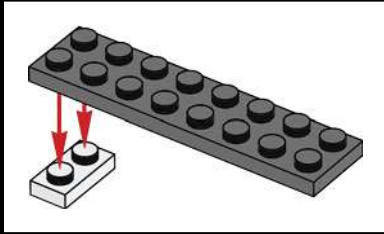

400

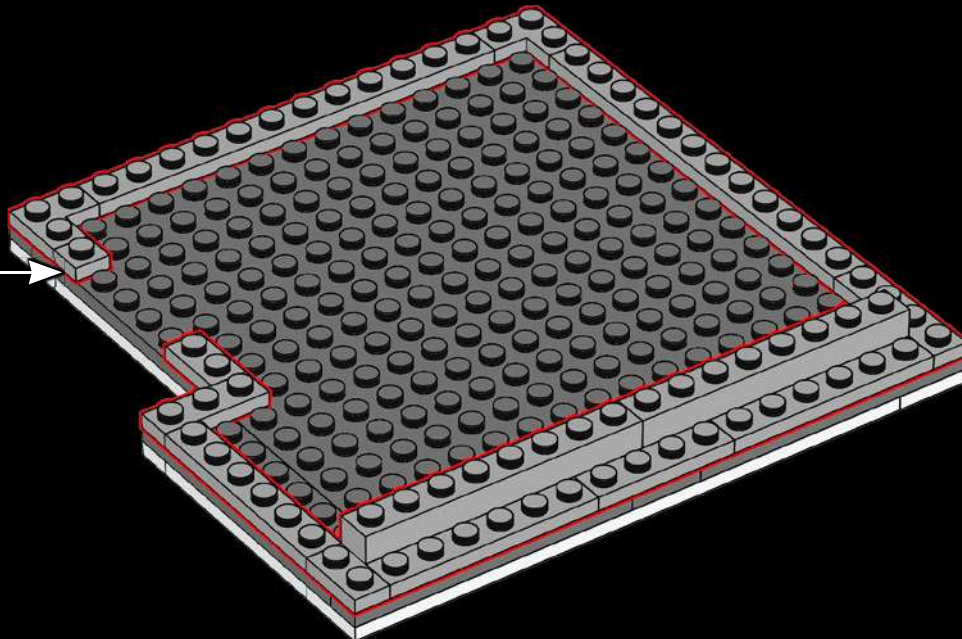

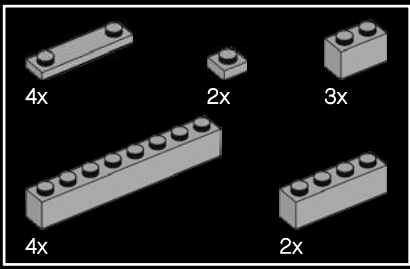

401

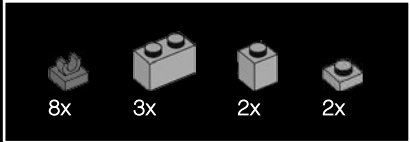
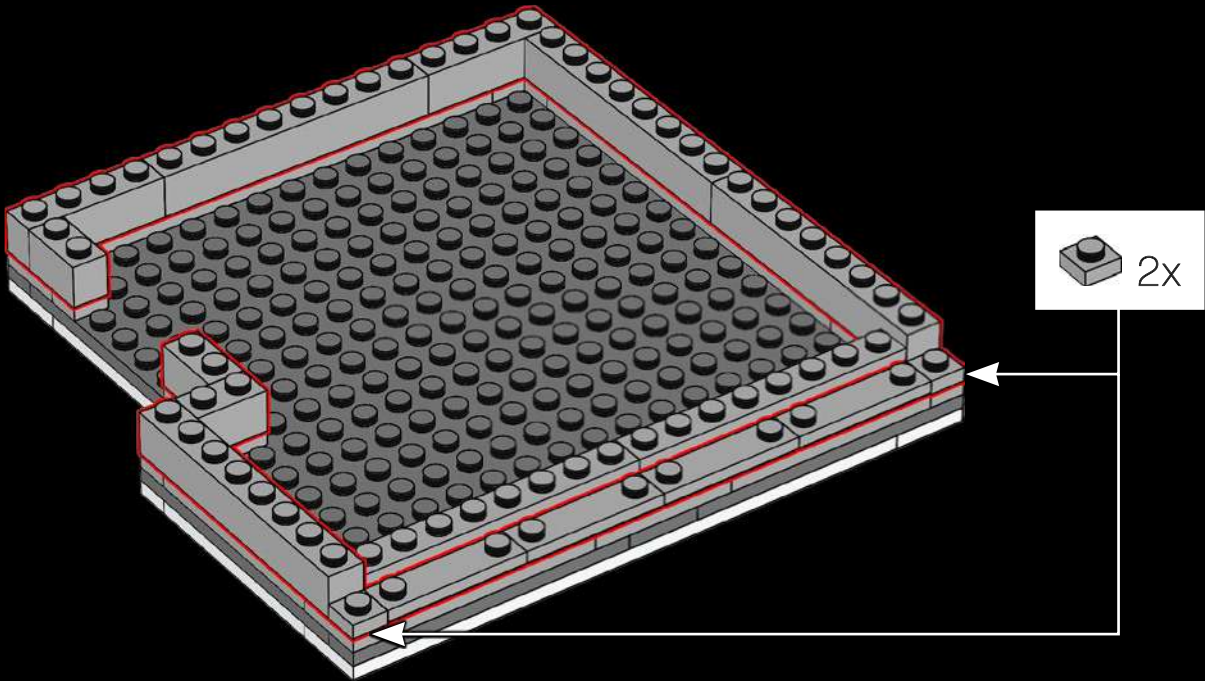

402

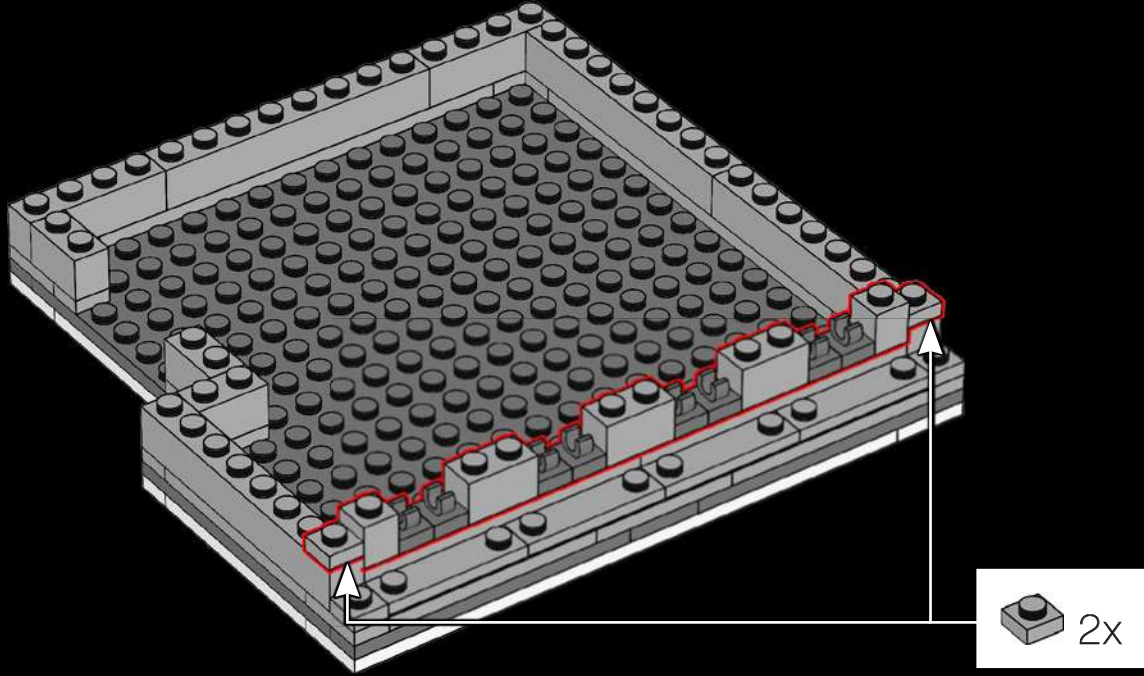

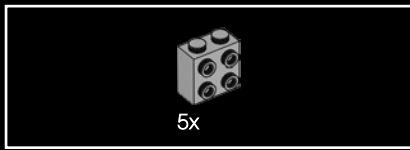

403

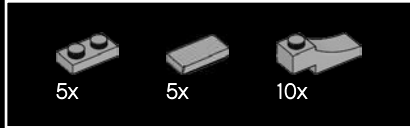
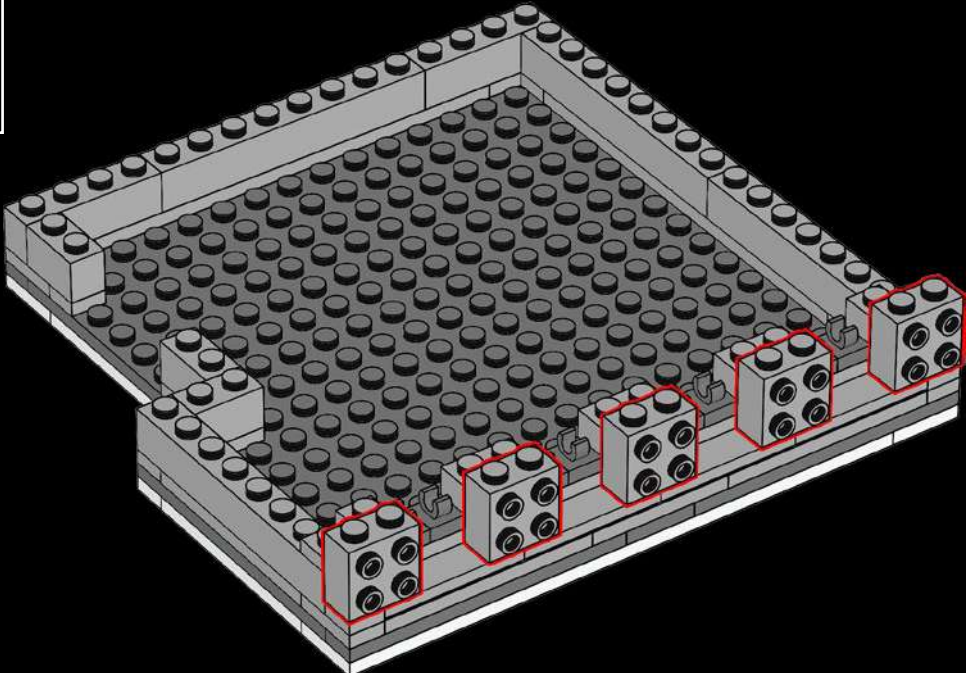

404

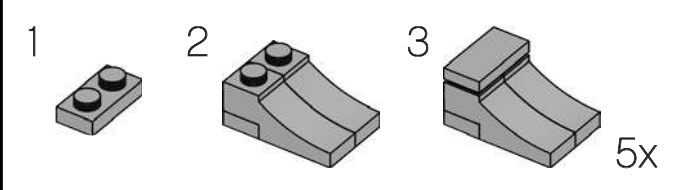
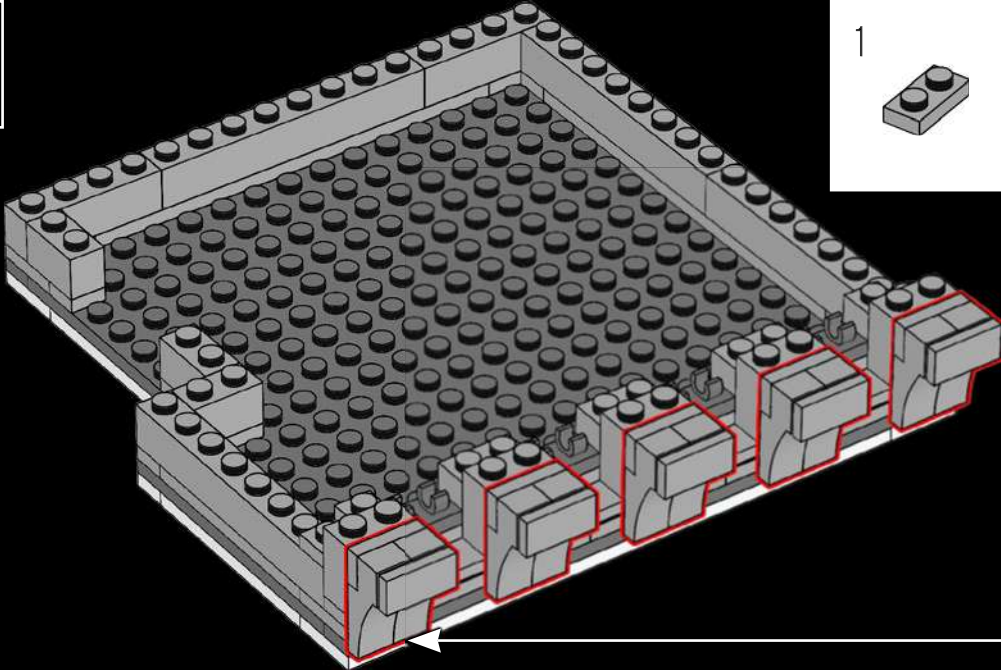

Did you notice the cornice is crafted using a familiar animal head flipped upside down?

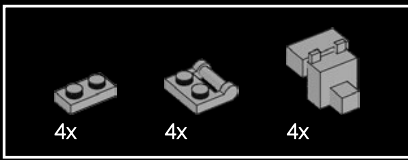

405

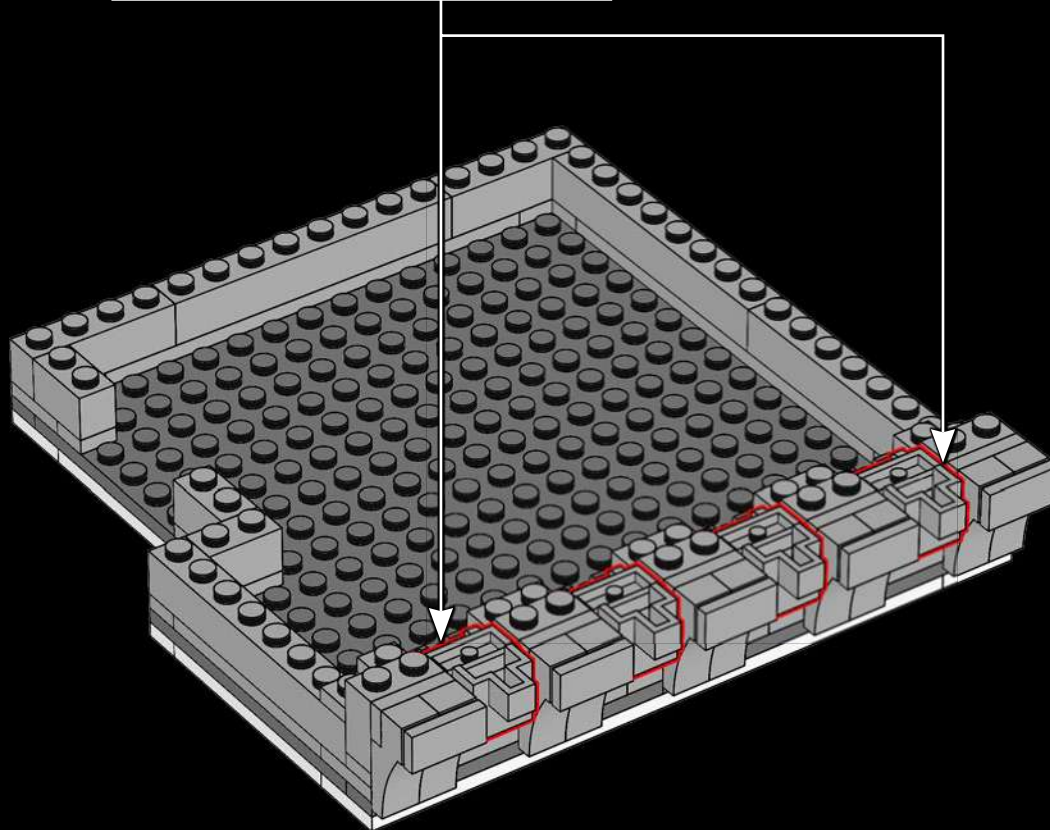
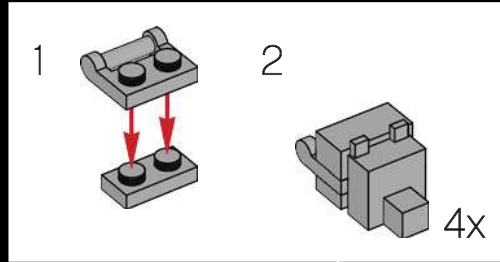

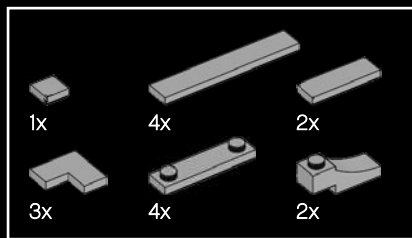

406

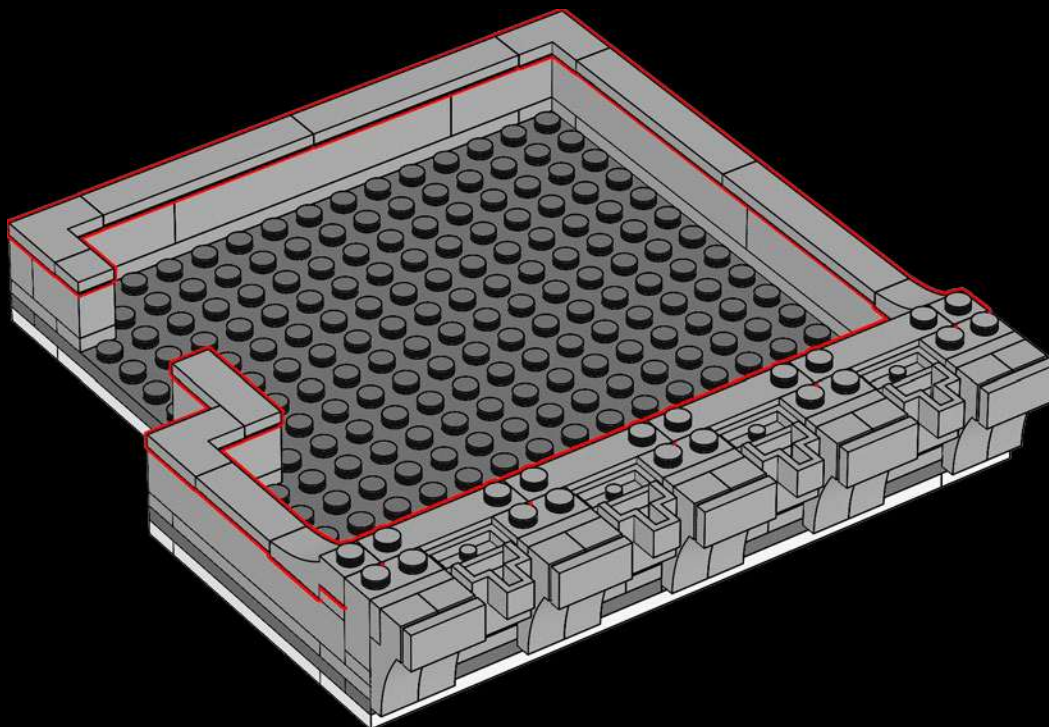

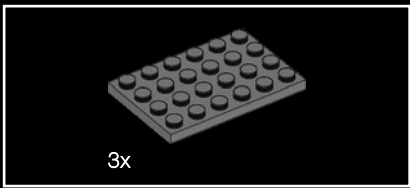

407

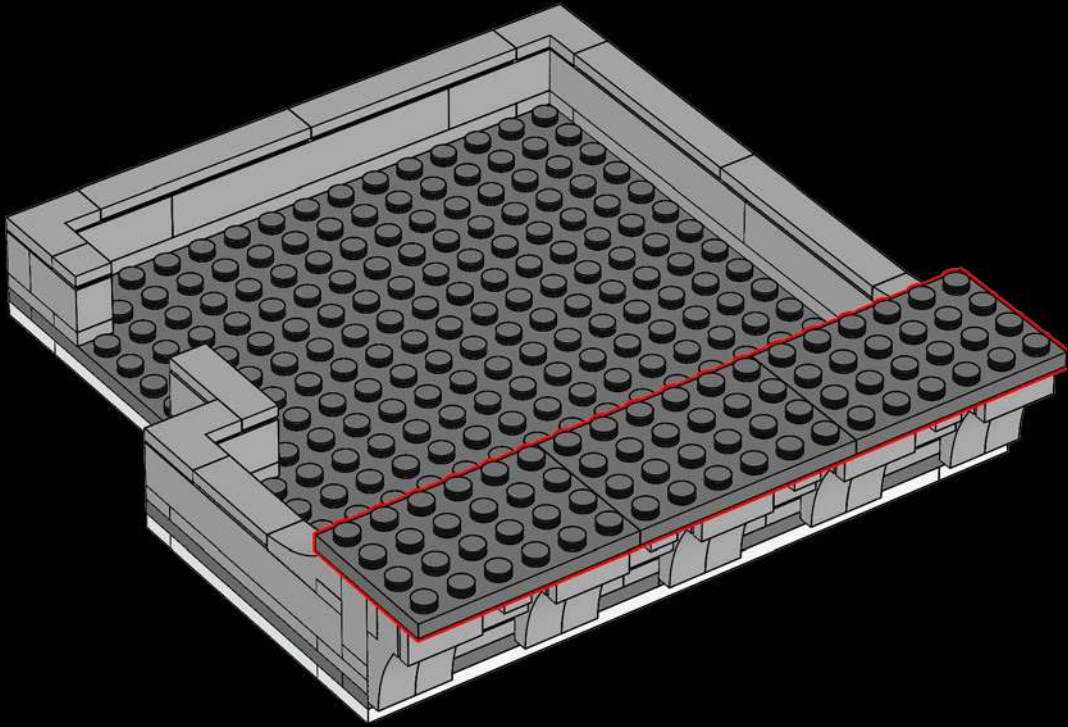

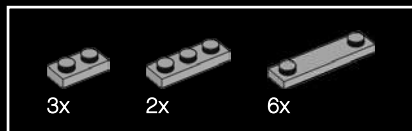

408

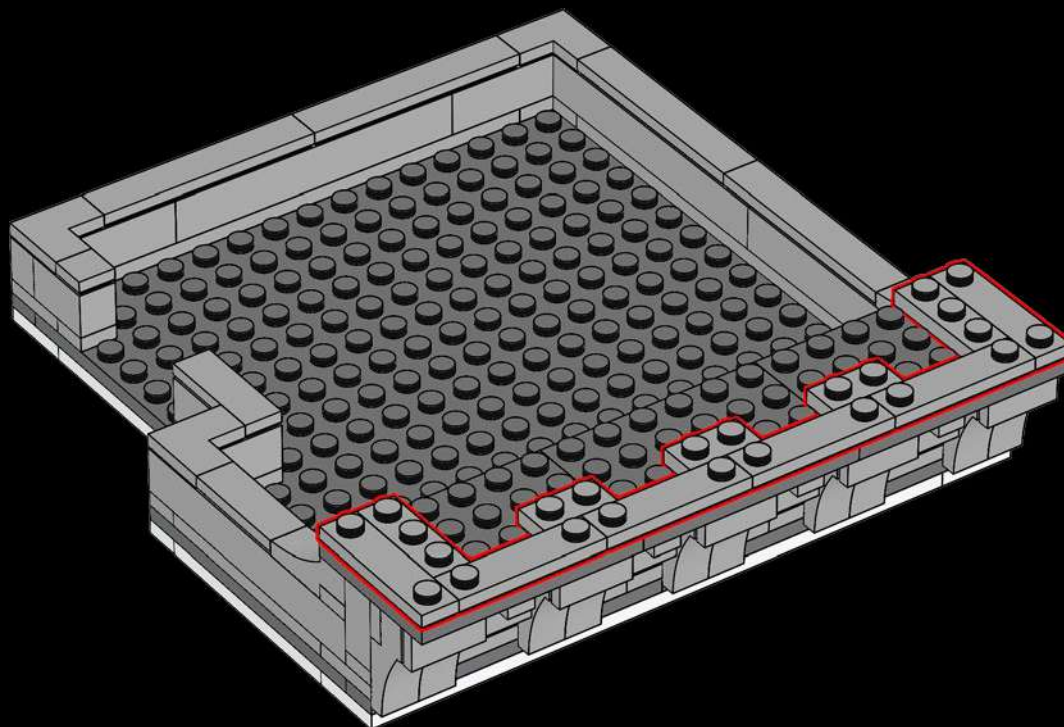

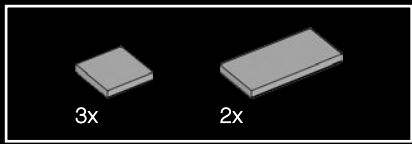

409

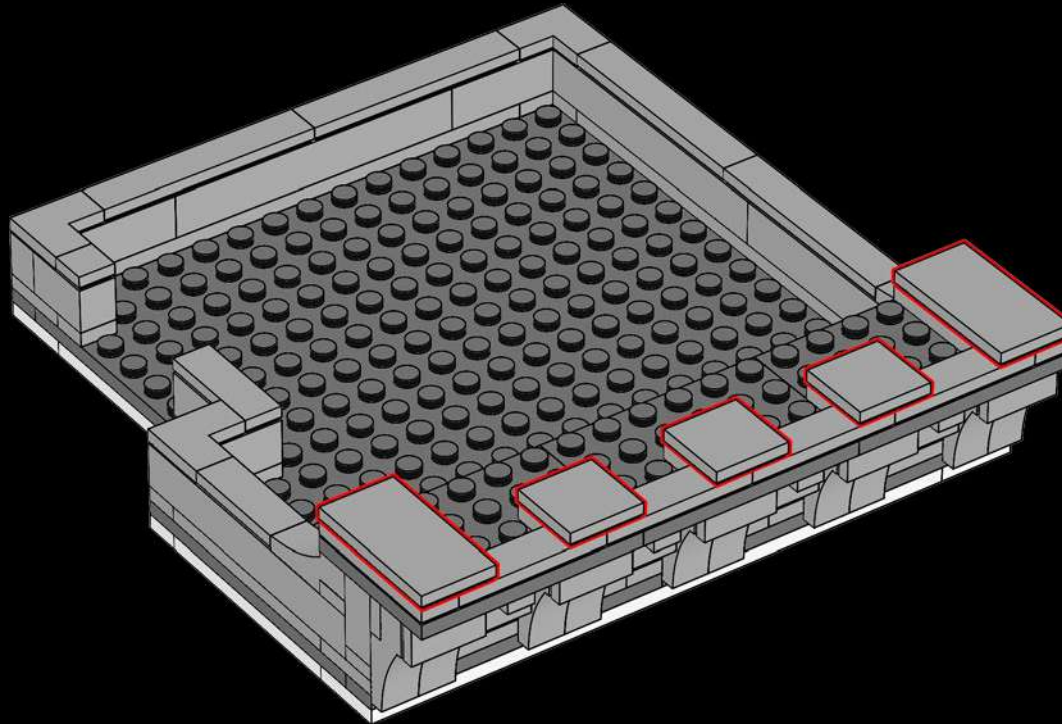

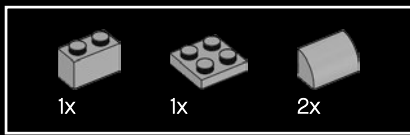

410

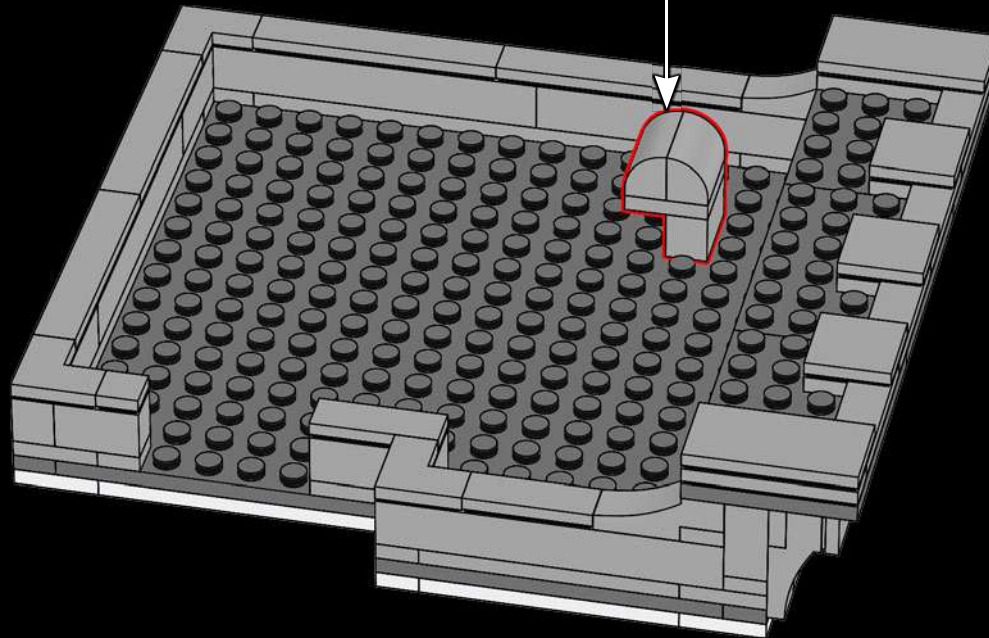
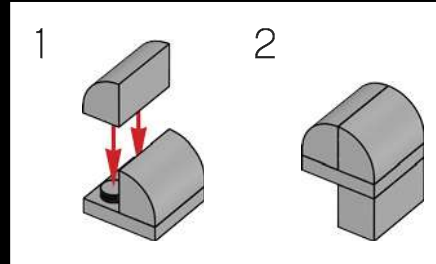

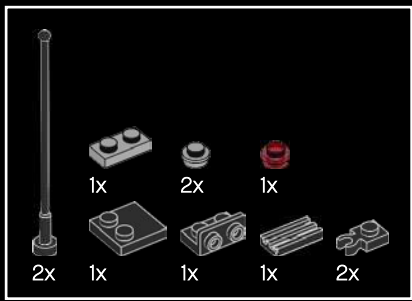

411

1

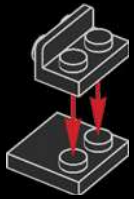

2

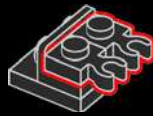

3

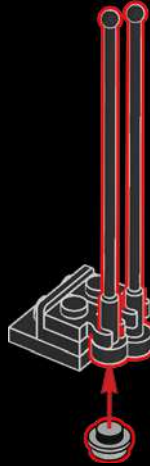

4

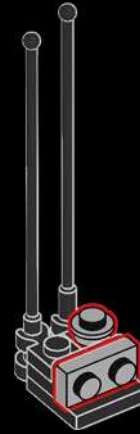

5

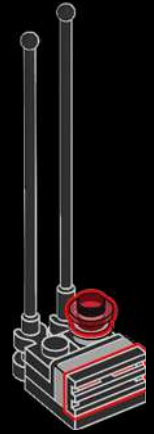

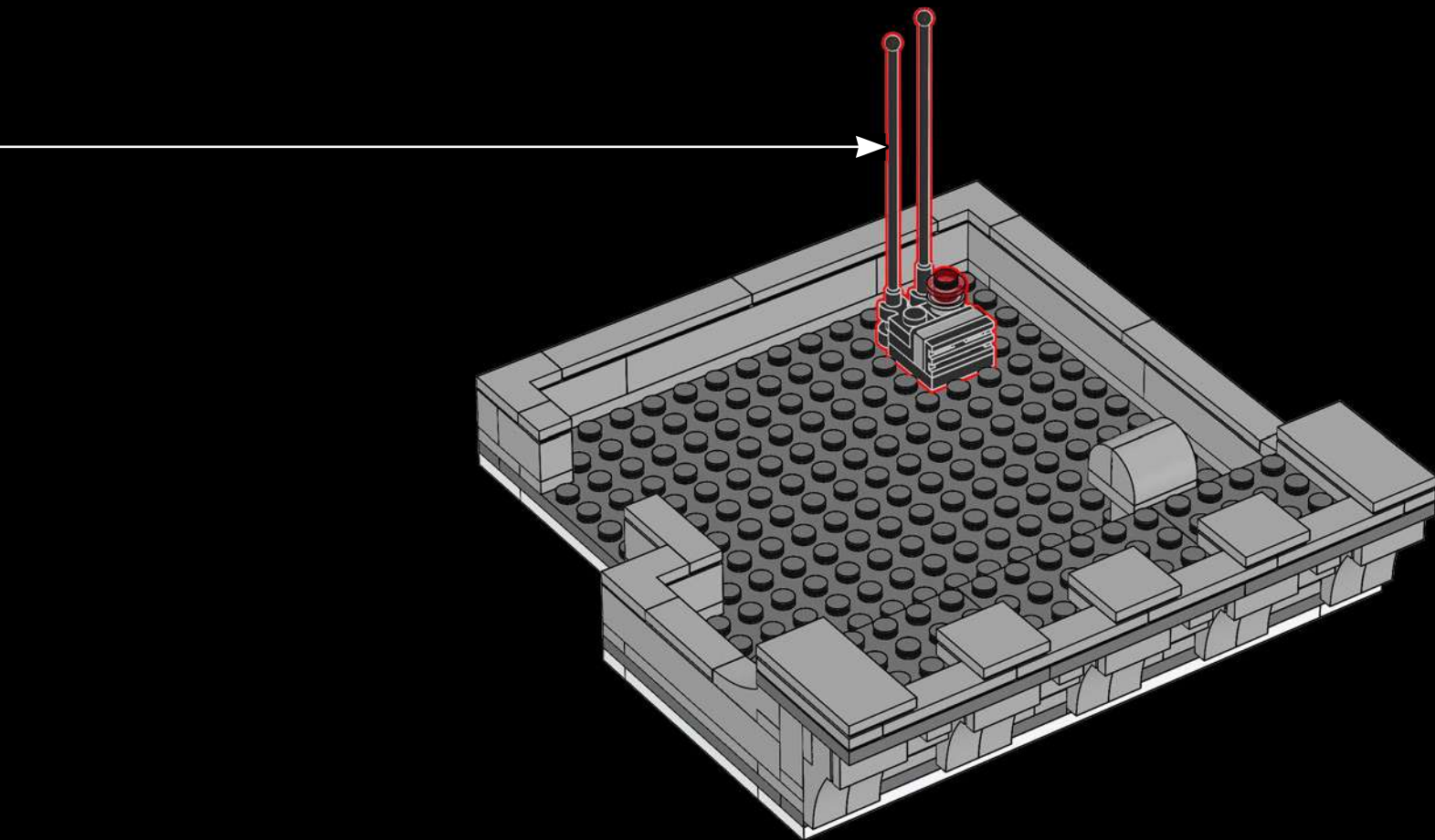

412

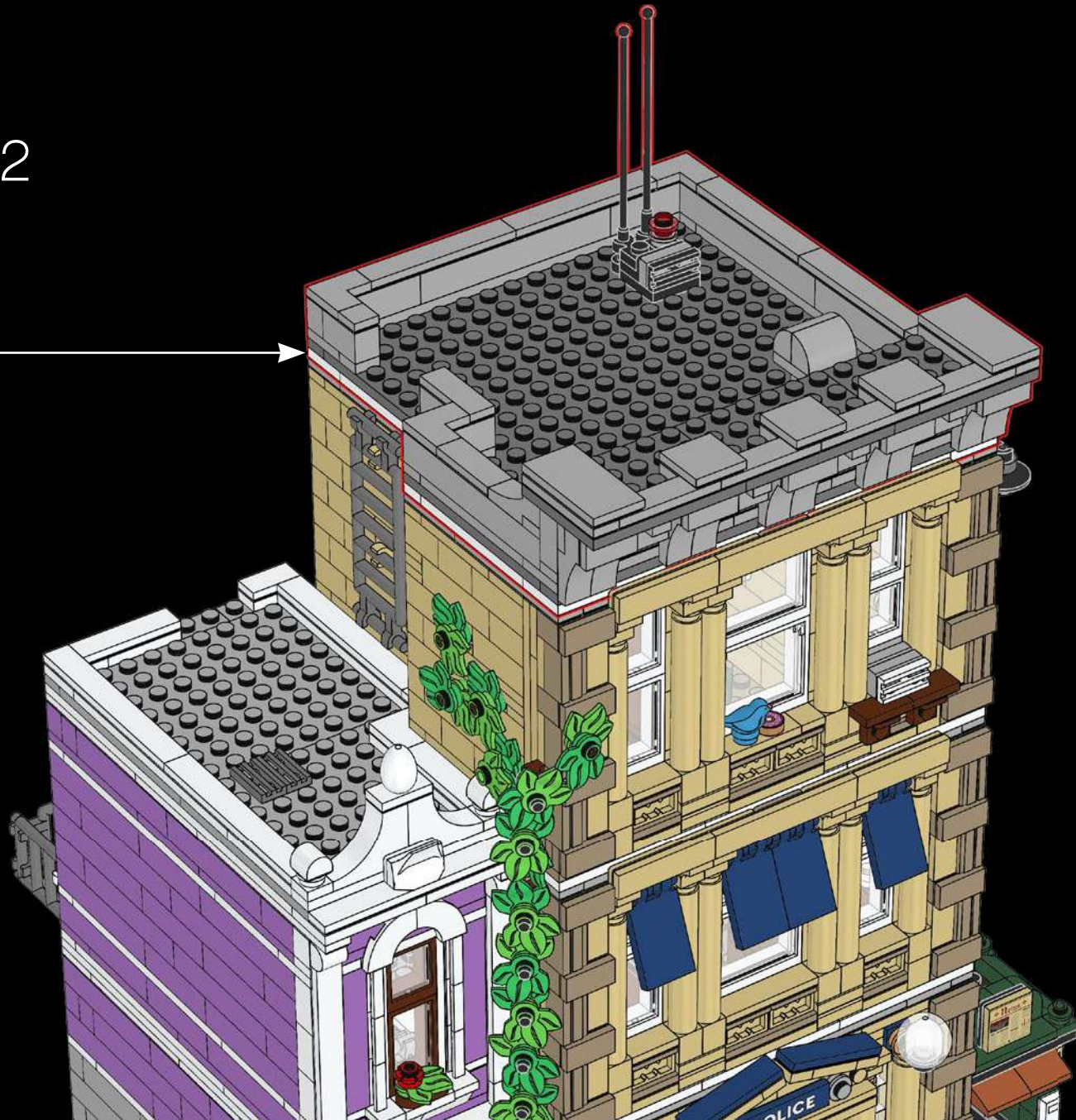

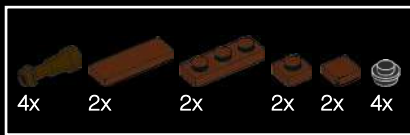

413

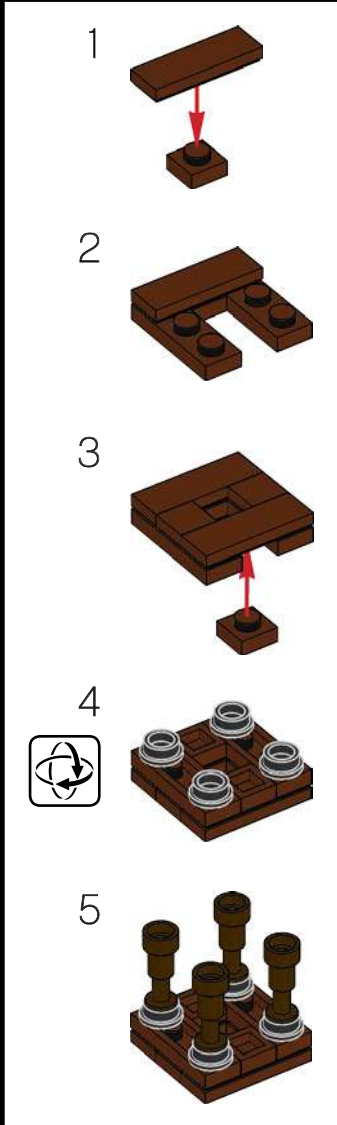

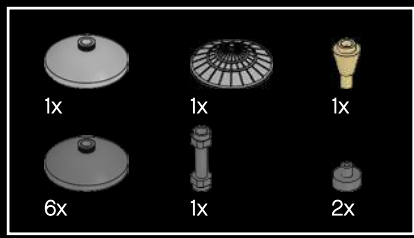

414

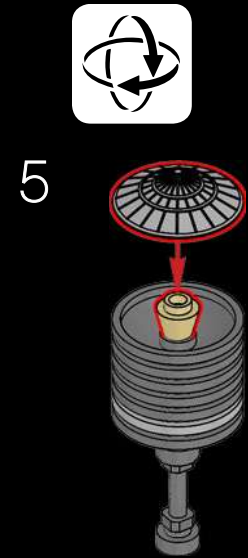
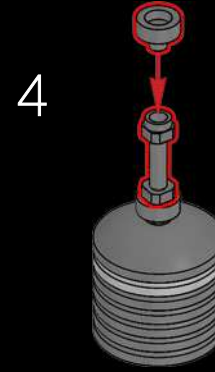
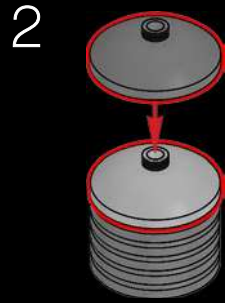
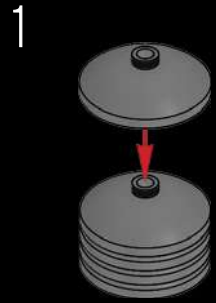

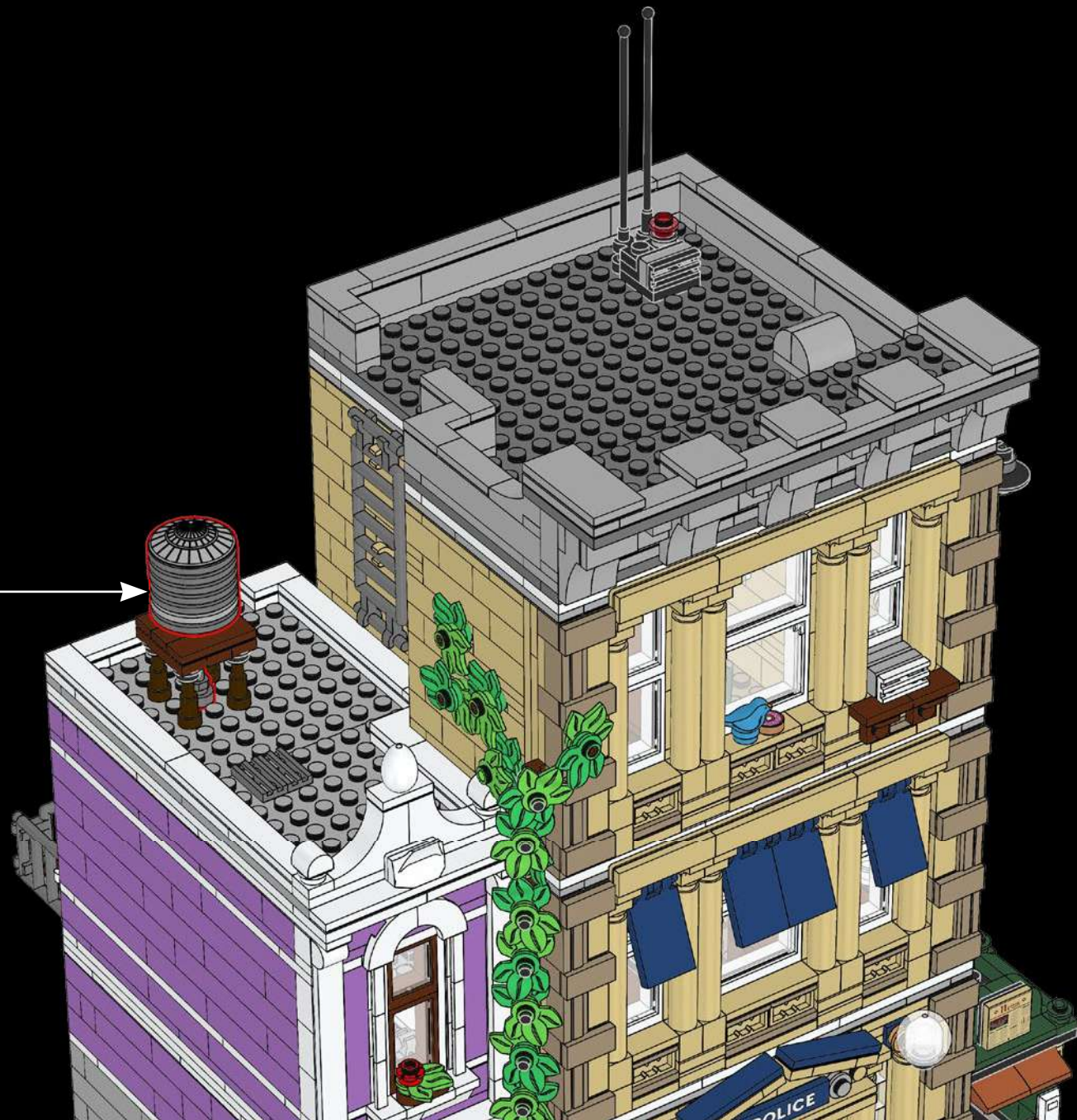

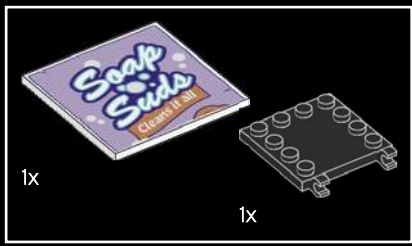

415

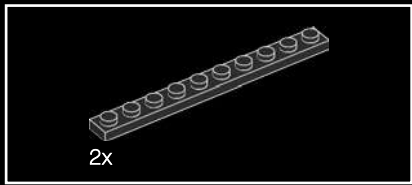
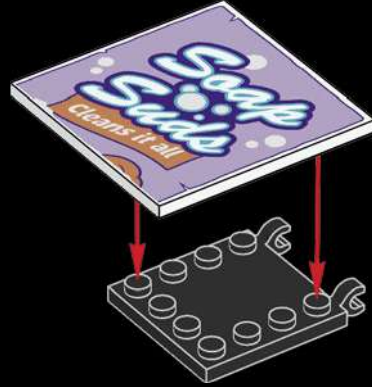

416

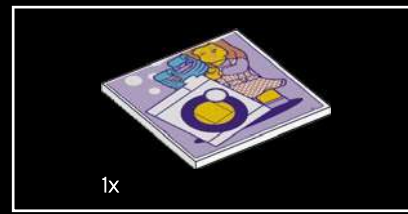
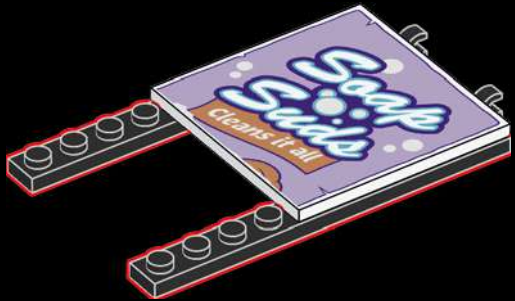

417

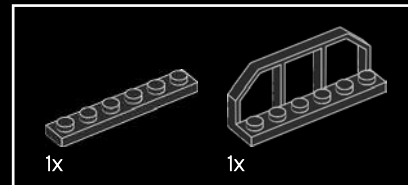

418

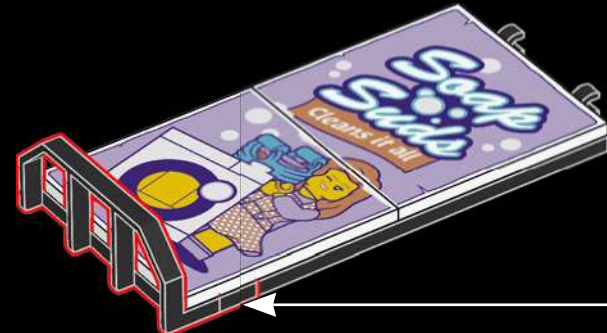
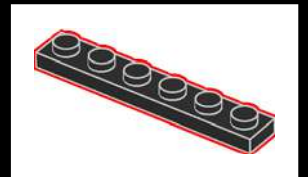

419

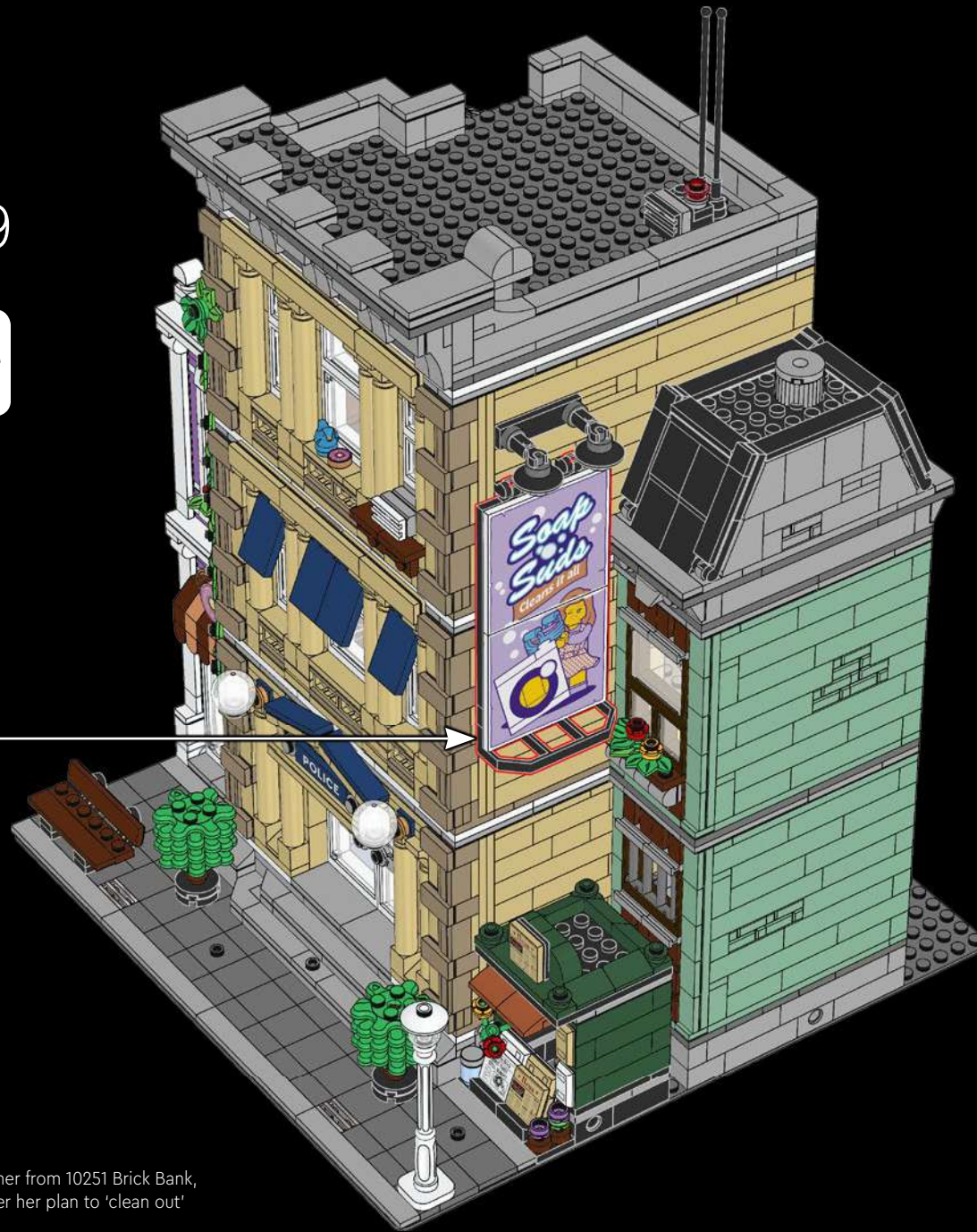

The billboard shows the clever laundrette owner from 10251 Brick Bank, who is convinced the police will never discover her plan to 'clean out' the vault.

- 1x 306201
- 3x 4518400
- 17x 6186681
- 10x 614101
- 1x 6143595
- 2x 6235083
- 11x 302401
- 10x 307001
- 2x 4504369
- 6x 6258135
- 4x 4558952
- 10x 6218841
- 1x 300501
- 1x 6210272
- 2x 6330191
- 2x 4547489
- 4x 6050914
- 1x 6052201
- 1x 474001
- 1x 9327
- 1x 6295301
- 1x 4113261
- 3x 6210076
- 1x 241201
- 4x 6051511
- 5x 4536521
- 2x 370001
- 10x 302301
- 1x 300401
- 1x 6176240
- 12x 306901
- 5x 4521210
- 3x 6117940
- 3x 6070698
- 1x 6097637
- 1x 6014274
- 1x 6011794
- 2x 6250019
- 6x 4249563
- 1x 303401
- 1x 6323426
- 1x 6323425
- 2x 611101
- 2x 6172674
- 5x 242001
- 7x 6058329
- 2x 4612342
- 1x 362201
- 2x 6110019
- 1x 4521943
- 1x 6248223
- 14x 447701
- 3x 346001
- 7x 4119227
- 3x 243101
- 5x 371001
- 9x 4530590
- 3x 6262945
- 1x 4560178
- 10x 302001
- 8x 366601
- 6x 663601
- 2x 379501
- 11x 416201
- 10x 303201
- 2x 6323424
- 3x 6218822
- 6x 6126046
- 5x 306801
- 6x 302201
- 6x 362301
- 4x 6317345
- 2x 302101
- 3x 6156667
- 4x 6249091
- 1x 6017003
- 17x 4161734
- 34x 4159553
- 2x 4579260
- 2x 4516055
- 16x 6178916
- 2x 4125253
- 33x 4113915
- 9x 6057517
- 4x 6232135
- 2x 4112980
- 1x 6177890
- 1x 6177891
- 5x 4278422
- 1x 6323422
- 1x 6323423
- 1x 4125220
- 16x 6236425
- 9x 6092587
- 2x 6313119
- 4x 6148262
- 1x 6146221
- 19x 4159279
- 15x 6024495
- 2x 6063943
- 37x 4109995
- 25x 4114026
- 2x 6271228
- 59x 4113917
- 2x 4114064
- 2x 6249809
- 7x 4550324
- 1x 4201062
- 21x 4113233
- 34x 4113916
- 14x 4124067
- 18x 4112982
- 7x 4157277
- 6x 4181134
- 6x 6288331
- 1x 4544139
- 6x 4114324
- 31x 4159774

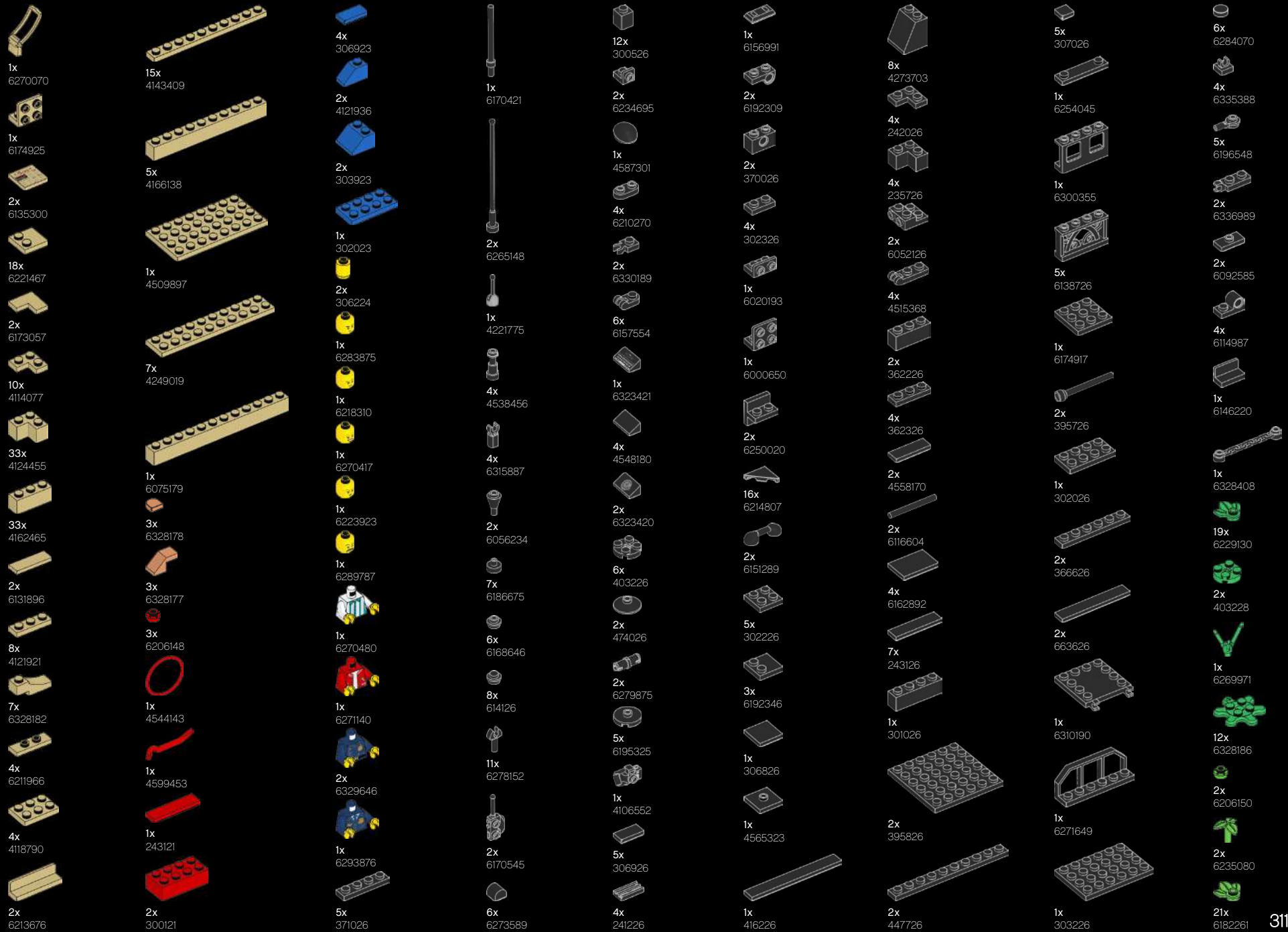

2x 6313114	18x 4211389	1x 4641048	7x 4211349	6x 4211396	1x 6335378	1x 4210934	27x 4211055	1x 6296951
4x 6186657	3x 6225242	4x 6131700	2x 4654577	2x 6171894	1x 6337268	1x 4210872	2x 4211054	3x 6284596
16x 4211388	1x 6186013	5x 4244627	1x 6187170	2x 6315580	3x 4211425	1x 4210869	2x 6177079	6x 6271752
35x 4211398	1x 4211508	2x 6319336	1x 6070564	2x 6315580	10x 4211481	2x 6092572	2x 4210635	9x 6344022
15x 4211414	1x 6281998	6x 6126082	1x 6070564	1x 4211421	1x 4211481	2x 4210631	1x 4210702	2x 4210719
1x 4211440	9x 6248890	3x 4211397	1x 6251044	23x 4211394	1x 4251149	5x 4211063	6x 4210865	3x 4211056
4x 6326078	2x 6227897	5x 4211413	10x 4211428	8x 4211445	1x 4211521	17x 4211052	9x 4211002	9x 4211002
1x 6254402	1x 4211735	1x 6102357	11x 4211429	20x 4211356	1x 4211462	2x 4211066	4x 4210998	4x 4210998
2x 4211564	2x 4568637	2x 6212077	12x 6329117	3x 4211636	2x 4514846	1x 4211335	1x 4211008	1x 4211008
2x 6227184	2x 6179186	5x 4211353	4x 4558169	21x 6257593	1x 4211402	1x 6250018	6x 4211115	6x 4211115
9x 6066097	1x 4650645	18x 6065824	1x 6248917	2x 6315579	1x 4211402	1x 4543086	4x 4211001	4x 4211001
5x 6000066	2x 6092956	5x 4211387	2x 6315579	3x 4211395	3x 4166618	5x 6310596	1x 4210997	1x 4210997
7x 6123809	1x 6125569	2x 4211436	2x 4211773	1x 6168615	2x 4210794	3x 6126083	4x 4667977	4x 4667977
5x 6004990	1x 6248492	1x 6034676	1x 6170385	18x 4560183	1x 6133611	1x 4211094	1x 6262942	4x 4211134
14x 4211568	8x 4515374	4x 6177078				8x 6309059	1x 4211065	



1x 6037634

1x 6004927

1x 6139364



1x 6257433



2x 4535928



1x 6195266

2x 6238674



4x 6328188

4x 4538950

4x 6252667

5x 6328181

1x 6226792

2x 4518687

2x 6337282



2x 6209684

8x 4619521

1x 6097301

8x 6125776

11x 4651903

3x 6347299

1x 6152645

21x 4623598

15x 4619512

8x 6173813

3x 4619524

14x 6107188

2x 6265058

26x 6251908

9x 4649745



1x 6055172

2x 4549436

42x 4496699

42x 4528604

6x 6310835

11x 4521914

8x 6330148

20x 6250168

6x 6328183

2x 6126075

5x 4507045

3x 4550168

1x 6132768

2x 6164288

2x 4267874

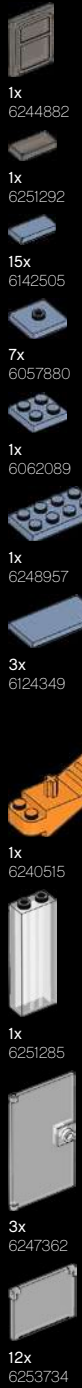

1x 6244882

1x 6251292

15x 6142505

7x 6057880

1x 6062089

1x 6248957

3x 6124349

1x 6240515

1x 6251285

3x 6247362

12x 6253734



4x 6285587

2x 6247798

1x 6274738

6x 6168665

14x 6220959

10x 6254552

8x 6252258

1x 6238856

2x 6266626

1x 6163901

1x 6286876

1x 6240204

1x 6251294

Customer Service
Kundenservice
Service Consommateurs
Servicio Al Consumidor

LEGO.com/service or dial

00800 5346 5555 :     

1-800-422-5346 :  





FEEDBACK AND WIN



FEEDBACK AND WIN

Your feedback will help shape the future development of this product series.

Please visit:

FEEDBACK UND GEWINNEN

Dein Feedback trägt zur Weiterentwicklung dieser Produktreihe bei.

Geh auf:

COMMENTEZ ET GAGNEZ

Vos commentaires nous aideront à concevoir les futurs produits de cette gamme.

Rendez-vous sur :

COMENTA Y GANA

Tu opinión nos ayudará a dar forma al desarrollo de esta serie de productos en el futuro.

Visita:

反馈有奖

您的反馈将有助于我们在今后改进本系列产品。

请访问：

[LEGO.com/productfeedback](https://www.lego.com/productfeedback)

By completing, you will automatically enter a drawing to win a LEGO® set.

Terms & Conditions apply.

Durch Ausfüllen nimmst du automatisch an der Verlosung eines LEGO® Preises teil.

Es gelten die Teilnahmebedingungen.

En envoyant vos commentaires, vous serez automatiquement inscrit(e) à un tirage au sort qui vous permettra de remporter un prix LEGO®.

Offre soumise à conditions.

Al contestar, participarás automáticamente en el sorteo y podrás ganar un set LEGO®.

Sujeto a Términos y Condiciones.

完成我们的反馈调查，即可自动进入抽奖环节，赢取乐高®套装。

适用《条款和条件》。

